



# **GlobalMap Sport<sup>TM</sup>**

## **INSTALLATION AND OPERATION INSTRUCTIONS**

** <sup>®</sup>LOWRANCE ELECTRONICS, INC.  
12000 E. SKELLY DR., TULSA, OK 74128**

Copyright © 1996 Lowrance Electronics, Inc.  
All rights reserved.

GlobalMap Sport™, IMS SmartMap™ are trademarks of  
Lowrance Electronics, Inc.  
Lowrance® is a registered trademark of Lowrance Electronics, Inc.

### **WARNING!**

**USE THIS MAPPING UNIT ONLY AS AN AID TO NAVIGATION. A CAREFUL NAVIGATOR NEVER RELIES ON ONLY ONE METHOD TO OBTAIN POSITION INFORMATION.**

**Never use this product while operating a vehicle.**

The background map built into this unit is not intended for navigation and its accuracy has not been verified. This map is derived from U.S. government sources which rely on ground and aerial surveys and satellite data. Since there can be inaccuracies in the data used to create the maps and in the map's resolution, plus position inaccuracies in the navigation system, use caution when using this product.

### **CAUTION**

When showing navigation data to a position (waypoint), this unit will show the shortest, most direct path to the waypoint. It provides navigation data to the waypoint regardless of obstructions. Therefore, the prudent navigator will not only take advantage of all available navigation tools when travelling to a waypoint, but will also visually check to make certain a clear, safe path to the waypoint is always available.

The storage temperature for your unit is from -4 degrees to +167 degrees Fahrenheit (-20 to +75 degrees Celsius). Extended storage temperatures higher or lower than specified will cause the liquid crystal display to fail. Neither this type of failure nor its consequences are covered by the warranty. For more information, consult the factory customer service department.

All features and specifications subject to change without notice.  
All screens in this manual are simulated.

|  |    |
|--|----|
| INTRODUCTION .....                     | 5  |
| INSTALLATION .....                     | 6  |
| BATTERY INSTALLATION .....             | 6  |
| EXTERNAL POWER .....                   | 7  |
| ANTENNA .....                          | 7  |
| ANTENNA ANGLE .....                    | 8  |
| MAP CARTRIDGE INSTALLATION .....       | 9  |
| REMOVING MAP CARTRIDGE .....           | 10 |
| KEYBOARD .....                         | 10 |
| OPERATION .....                        | 11 |
| TURNING POWER ON .....                 | 11 |
| MENUS .....                            | 11 |
| FINDING YOUR POSITION .....            | 11 |
| POSITION/NAVIGATION DISPLAYS .....     | 14 |
| NAVIGATION SCREEN .....                | 15 |
| MAPPING SCREEN .....                   | 15 |
| MAP CURSOR .....                       | 16 |
| MAP MENUS .....                        | 16 |
| PLOTTER OPTIONS .....                  | 16 |
| PLOT TRAIL .....                       | 17 |
| PLOT TRAIL FLASHING .....              | 18 |
| SET VISIBLE PLOT TRAILS .....          | 18 |
| CLEAR CURRENT PLOT TRAIL .....         | 18 |
| SAVE CURRENT PLOT TRAIL .....          | 18 |
| SET PLOTTER UPDATE CRITERIA .....      | 19 |
| MAP OPTIONS .....                      | 19 |
| TEXT LABELS .....                      | 20 |
| MAP BOUNDARIES .....                   | 20 |
| FIL WITH GRAY .....                    | 20 |
| COURSE-UP MODE .....                   | 21 |
| DETAIL CARTRIDGE .....                 | 21 |
| ICONS .....                            | 22 |
| PLACE ICON AT PRESENT POSITION .....   | 22 |
| PLACE ICON AT CURSOR POSITION .....    | 23 |
| ERASE ICONS .....                      | 23 |
| WINDOWS .....                          | 24 |
| SATELLITE INFORMATION SCREEN .....     | 24 |
| STEERING SCREEN .....                  | 25 |
| DUAL MAPPING .....                     | 26 |
| CLOCK .....                            | 26 |
| CLOCK SET .....                        | 26 |
| CLOCK ALARM .....                      | 27 |
| TIMERS .....                           | 28 |
| REPROGRAM WINDOW GROUPS .....          | 29 |
| RESET GROUPS .....                     | 29 |
| BACKLIGHT .....                        | 29 |
| UNITS OF MEASURE .....                 | 30 |
| POSITION FORMAT .....                  | 31 |
| COURSE HOLDING .....                   | 32 |
| DATUM .....                            | 32 |
| PCF (POSITION CORRECTION FACTOR) ..... | 33 |
| SYSTEM INFO .....                      | 34 |
| GPS COMMANDS .....                     | 34 |
| GPS SIMULATOR .....                    | 34 |
| GPS UPDATE RATE .....                  | 35 |

|   |    |
|---|----|
| EXECUTE GPS SELF-TEST .....                                     | 35 |
| EXECUTE GPS COLD START .....                                    | 35 |
| GPS ALARMS .....  | 36 |
| MESSAGES .....  | 37 |
| NMEA/DGPS .....   | 37 |
| CONFIGURE NMEA OUTPUT .....                                     | 38 |
| DGPS CONFIGURE .....  | 39 |
| SERIAL COMMUNICATIONS SETUP .....                               | 40 |
| NAME .....  | 41 |
| RESET OPTIONS .....   | 41 |
| WAYPOINT NAVIGATION .....                                       | 42 |
| SAVING PRESENT POSITION AS A WAYPOINT (QUICK SAVE) .....        | 42 |
| SAVING CURSOR POSITION AS A WAYPOINT .....                      | 42 |
| SAVING PRESENT POSITION AS A WAYPOINT (SELECT WAYPOINT #) ..... | 42 |
| SAVING CURSOR POSITION AS A WAYPOINT (SELECT WAYPOINT #) .....  | 43 |
| EDIT WAYPOINT LAT/LON .....                                     | 44 |
| WAYPOINT NAMES .....  | 44 |
| WAYPOINT ICONS .....  | 45 |
| DELETE A WAYPOINT .....   | 45 |
| MOVE A WAYPOINT .....   | 46 |
| DISTANCE BETWEEN WAYPOINTS .....                                | 46 |
| NAVIGATE TO A WAYPOINT .....                                    | 47 |
| NAVIGATING TO A WAYPOINT USING THE MAP .....                    | 47 |
| NAVIGATING TO A WAYPOINT USING THE STEERING SCREEN .....        | 48 |
| WAYPOINT OPTIONS .....  | 49 |
| ROUTES .....  | 49 |
| SELECT WAYPOINTS - WAYPOINT LIST .....                          | 50 |
| SELECT WAYPOINTS - FROM MAP .....                               | 51 |
| FINISHING THE ROUTE .....                                       | 51 |
| FOLLOWING A ROUTE .....   | 52 |
| WAYPOINT DETAIL .....   | 52 |
| DELETE A ROUTE .....  | 53 |
| NAVIGATE TO CURSOR POSITION .....                               | 53 |
| CANCEL NAVIGATION .....   | 54 |
| BATTERIES .....   | 54 |
| MAP 4 STEERING INDICATOR .....                                  | 54 |
| DEFINITION OF TERMS/ABBREVIATIONS .....                         | 55 |
| GPS - HOW IT WORKS .....  | 55 |
| ACCURACY .....  | 56 |
| WARRANTY .....  | 57 |
| UPS RETURN POLICY .....   | 58 |
| ACCESSORY ORDERING INFORMATION .....                            | 59 |
| HOW TO OBTAIN SERVICE - INTERNATIONAL .....                     | 60 |

## **Congratulations!**

You have purchased the finest hand-held GPS receiver Lowrance has ever made. With its large LCD screen, easy to use menus, and outstanding performance, we think you'll be happy with this product for a long time. No other hand-held GPS receiver on the market today has the GlobalMap Sport's™ combination of 5 channel receiver, inland and C-Map mapping cartridge capability, and programmable displays in a waterproof, handheld unit.

Please sit down with the unit and this manual and familiarize yourself with it before using it in the "real world". A simulator is built in, which lets you practice navigation, making waypoints and routes in the comfort of your home.

## **TIPS**

GPS works from satellites that transmit information to the world at very high frequencies. One disadvantage to this frequency is that it's "line-of-sight". In other words, the signals don't bounce around like your local radio or television. If you don't have a clear view of the sky, or if you're under a metal roof or awning, the unit probably won't be able to pick up the signals from the satellites. This is common among all GPS receivers. You can use it in a car, however, you may need to place the unit on the dash, or have a friend hold it near the window so the antenna can pick up the signals. The PA-1 remote antenna kit is available that lets you mount the antenna away from the unit.

Like most GPS receivers, your GlobalMap Sport™ doesn't have a compass or any other navigation aid built into it. It relies solely on the signals from the satellites to determine its position. Speed, direction of travel, and distance are all calculated from position information. Therefore, in order for it to determine the direction you're travelling, you must be moving, and the faster - the better. This is not to say the unit won't work at walking speeds - it will. But the faster you travel, the easier it is for the unit to determine your direction. That's why it can put seemingly random numbers in the TRK (Track) data box when you're standing still. It doesn't know which direction you're facing until you start moving.

Another factor that influences the GPS' position and navigation capabilities is called selective availability or SA. This is small errors purposefully injected into the transmitted signal from the satellites. The government does this to degrade the system's accuracy to civilian and foreign users. Even with SA, GPS is the most accurate navigation system ever invented on such a large scale.

# INSTALLATION

## BATTERY INSTALLATION

The GlobalMap Sport™ requires six AA batteries. We recommend DuraCell® alkaline batteries, but other brands will work. You can use lithium batteries which will last longer than alkaline batteries (but cost more) or rechargeable ni-cad batteries (won't last as long as standard alkalines). Rechargeable alkaline batteries such as RayOVac® Renewals® will also work satisfactorily.

Do not use heavy-duty batteries or any battery other than the ones listed above. Do not mix different types of batteries. (For example, don't use both alkaline and ni-cad batteries at the same time.)

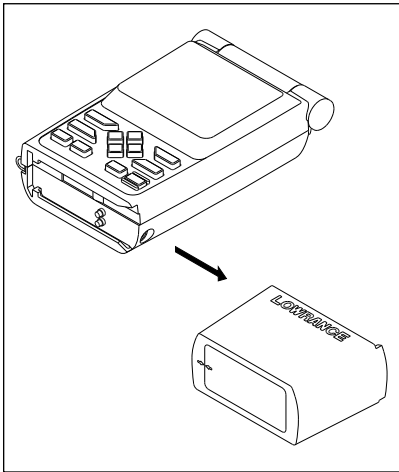

To install the batteries, first turn the GlobalMap Sport™ so that it is facing you. Now grasp the bottom part of the case and push it to the right until it comes completely off the unit. The bottom part of the case holds the batteries. Next, push the battery holder out the bottom of the battery cover as shown below. Install each battery with the negative end (-) against the spring. The positive end (+) of each battery should be firmly against the metal plate. When all six batteries are installed, slide the battery holder into the battery cover.

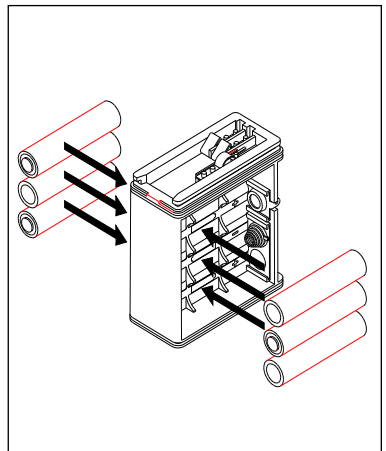
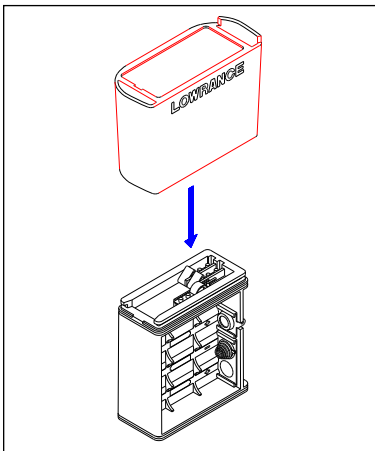

If the battery cover sticks when sliding into the battery cover, apply a thin film of petroleum jelly to the "O" rings on the battery holder.

### IMPORTANT!

There are arrows molded into the bottom of the battery cover and battery holder. Make certain the arrows are properly aligned! Otherwise, the battery holder won't slide all the way into the cover and the battery pack won't slide onto the unit.

Slide the battery pack onto the unit and the GlobalMap Sport™ is ready for use.

### EXTERNAL POWER

Instead of batteries, the GlobalMap Sport™ can operate on 6 to 35 volts DC from an external power source. To use external power, an adapter cable is supplied with your unit that will plug into your vehicle's cigarette lighter. To use this cable, simply plug one end into the GlobalMap Sport™ and the other end into the cigarette lighter. A rubber plug is supplied with your GlobalMap Sport™ to cover the external power jack on the side of the unit when it's not in use.

### ANTENNA

The GlobalMap Sport™ has a removable antenna that folds over the display when the unit is not in use. To open it, simply lift on an edge of the antenna and raise it to the desired height.

Two thumbscrews on the antenna's hinge let you adjust the tension on the antenna. This helps keep the antenna in the desired position. The thumbscrews work in opposite directions. To tighten the right thumb-screw, rotate it *away* from the display. To tighten the left thumbscrew, rotate it *toward* the display.

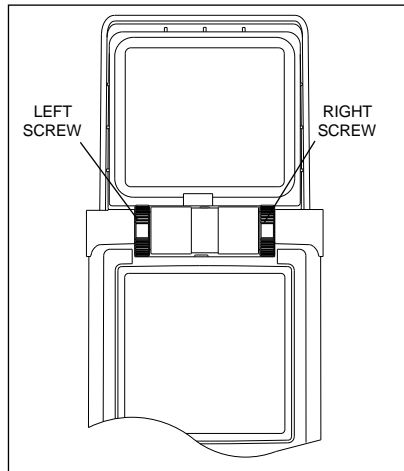

**Caution** - Always make certain the left thumbwheel is tight when using the GlobalMap Sport™. The connector for the antenna is inside the left thumbwheel. If it isn't tight, a poor connection can occur. This can prevent the unit from operating properly, if at all.

To remove the antenna, simply loosen the thumbwheels until they won't turn. Carefully remove the antenna from the unit by pulling it straight out. If you feel any resistance, make certain the thumbwheels are at the end of their travel. Don't force any parts!

You can see the antenna's connector inside the left thumbwheel once it's removed from the unit. When reinstalling the antenna, align the left side of the antenna first, then *slowly* thread the left thumbwheel until it engages the connector. This will require two full turns of the thumbwheel.

After you've done this, thread the right side of the antenna by rotating the right thumbwheel. Remember to rotate the right thumbwheel in the opposite direction from the left.

Tighten the thumbwheels to get the desired tension on the antenna. Caution - do not overtighten the thumbwheels.

### ANTENNA ANGLE

When using the GlobalMap Sport™, try to make certain the antenna is parallel with the ground, or nearly so as shown below. Since the signals from the satellites are "line of sight", a flat antenna gives you a better ability to receive the signals from all of the available satellites.

Also, trees, buildings, and carports can block the signals from the satellites. When using this unit in heavy brush or timber, remember that it may lose track on one or all of the satellites until you move into a clearing.

We have successfully used the GlobalMap Sport™ in cars and trucks since the satellite's signal passes through glass. However, antenna placement inside the vehicles can make a difference in receiving signals.

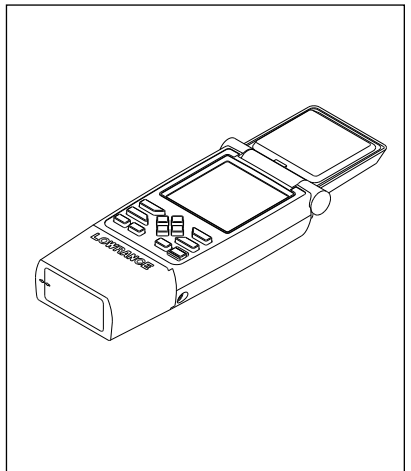
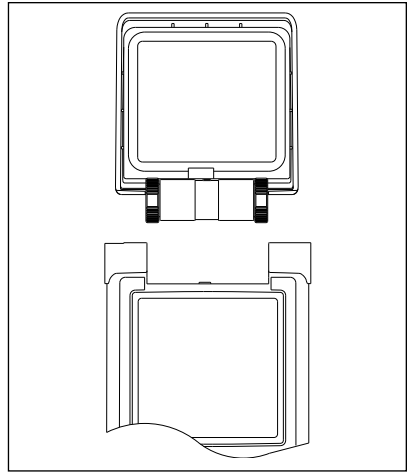



## MAP CARTRIDGE INSTALLATION

The GlobalMap Sport™ uses both Lowrance IMS SmartMap™ and C-Map cartridges, both of which are packaged in a cartridge housing specifically designed for Lowrance products.

The IMS cartridges contain digitized data of over 120,000 bodies of water. Nearly all inland waterways-public and private lakes, rivers, and streams, plus coastal United States waters up to 25 miles out are included. There are also state and U.S. interstate highways and routes. These inland mapping cartridges cover the entire continental United States in 64 highly detailed cartridges.

The C-Map cartridges cover most of the world with detailed views of coastal waters. Over 500 cartridges are available.

The GlobalMap Sport™ can hold up to two map cartridges, in any combination: Two Lowrance IMS SmartMaps or two C-Maps, one of each, or only one.

To install a cartridge into the GlobalMap Sport™, *first make certain the unit is turned off.* **Never install or remove a cartridge with the unit turned on!** You can damage your unit if you install or remove a cartridge with the unit turned on. Next, pry the cover off the back of the unit. Place the cartridge into either slot with its label facing you as shown below. Now slide the cartridge towards the top of the GlobalMap Sport™ until it stops. Replace the cover and the cartridge is ready for use.

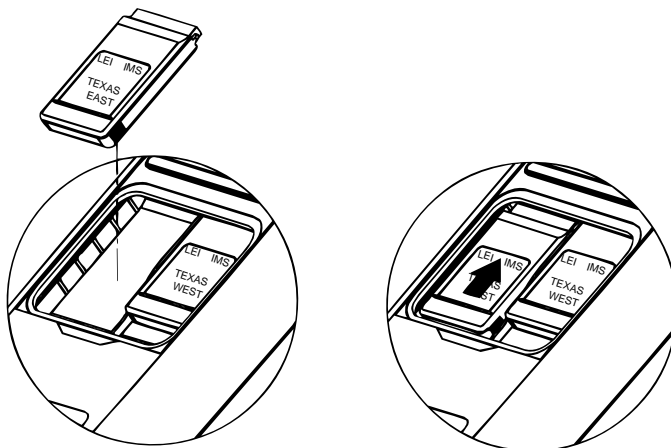

## REMOVING A CARTRIDGE

If you have difficulty removing a cartridge, use the back cover as a removal tool. Simply press one side of the cover against the ridge on the cartridge and gently push towards the bottom of the unit. Don't use a corner of the cover - it could damage it.

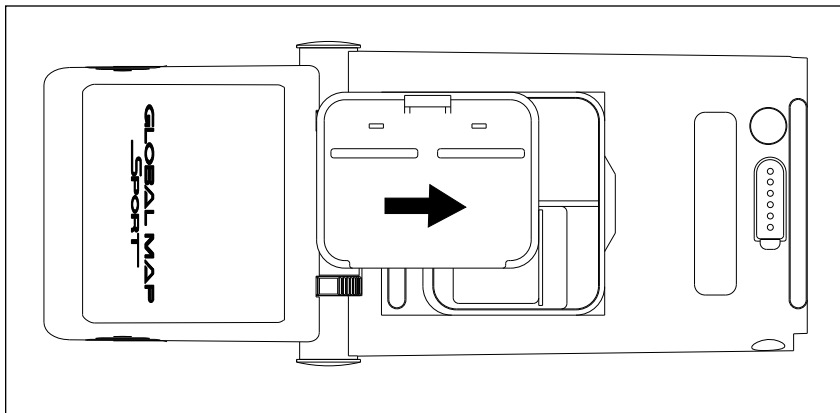

## KEYBOARD

The key board has twelve keys. The arrow keys are tied to most of the features, letting you easily move the mapping cursor, navigate through the menus, make selections from menus, and other tasks.

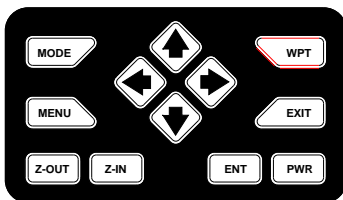

The WPT key lets you create, save, and recall waypoints and routes. The MODE key switches the unit between the four major displays: windows, position, navigation, and mapping. To select different features, or to modify functions, press the MENU key. The Z-OUT and Z-IN keys zoom-out and zoom-in your view on the mapping screen. The ENT and EXIT keys let you enter or erase selections. The PWR key turns the GlobalMap Sport™ on and off.

Note: To turn the unit off, you must hold the PWR key down for a few seconds.

# OPERATION

## Turning Power On

To turn the GlobalMap Sport™ on, simply press the PWR key. A screen similar to the one at right appears. Read the message on the screen, then press the EXIT key to erase it. The GlobalMap Sport™ is now ready for use.



## MENUS

Most of the GlobalMap Sport™'s adjustments and features are found on "menus". Pressing the MENU key lets you view the menus. Different menu items are added to the basic list, depending on which mode (mapping, navigation, or windows) the unit is in. This gives you the features that are specific to the mode you are in, but also has items that are used on all modes.

To erase the menu, simply press the EXIT key.

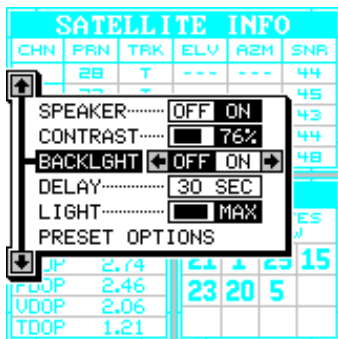

## Finding Your Position

### Cold Start

When the GlobalMap Sport™ is turned on for the very first time, it doesn't know where it is, nor what the local time or date is. If you tell it your position, time, and date, the unit will take much less time to lock-on to the satellites and give you a fix or position.

However, if you don't want to push buttons at this time, that's fine. The GlobalMap Sport™ will lock onto the satellites and give you a position without any input from you. This is called a "cold-start". It simply means that the unit is searching without help for the satellites that are in orbit. A cold-start can take up to 15 minutes to acquire enough satellite data to determine your position, although it typically takes less time than that.

Once the GlobalMap Sport™ locks on to the satellites and finds your position, it stores the satellite data in its memory. The next time you use the unit, it should take much less time to lock on.



Press the up or down arrow keys until the black box surrounds the “GPS COMMANDS” menu as shown at right. Now press the right arrow key. The screen shown below appears.

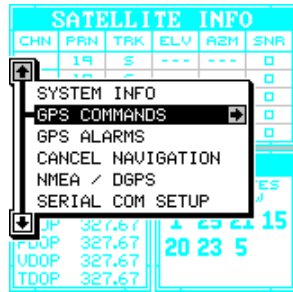

Using the down arrow key, move the black box to the “Initialize GPS Receiver” menu, then press the right arrow key. The screen shown below appears.



This is the GPS setup screen. The position, altitude, time, and date the GlobalMap Sport™ is currently using to find the satellites is shown at the bottom of this screen. Changing these values to your local position and time will speed the satellite lock much more.

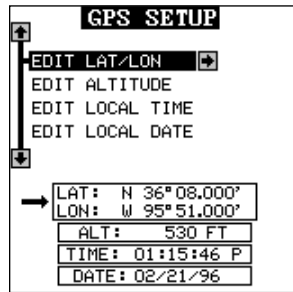

To change the position, press the right arrow key while the “EDIT LAT/LON” box is highlighted. The screen shown below appears.

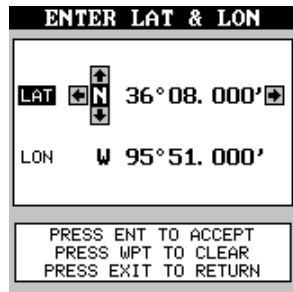

If your latitude is south, press the up or down arrow key to change it. If it is north, press the right arrow key to move the change box to the first number in the latitude. Now press the up arrow key to increase the number or the down arrow key to decrease it. Once the first number in the latitude is set, press the right arrow key once to move to the next number in the latitude.

Keep pressing the arrow keys until the latitude and longitude are set to your local position. (Note: This position does not have to be very accurate. If you can get it within one degree of your actual position, that will be fine.) When it's set, press the ENT key. The GlobalMap Sport™ accepts your entry and returns to the GPS setup menu.

Now change the local time and date if they're incorrect on this screen. (Don't worry about altitude.) When everything is acceptable, press the EXIT key to return to a mode screen. The GlobalMap Sport™ will instantly use the data you entered to find the satellites in the sky. (The unit knows which satellites will be available at the position, date, and time you entered. Therefore, it will only look for those satellites, making the search time much shorter than a cold start which looks for all of the satellites until it finds three.)

Once the GlobalMap Sport™ finds and locks on to three satellites, it stops flashing the numbers on the display. (Note: Altitude will still flash until the unit locks on to the fourth satellite. It takes four satellites to determine altitude.) It also sounds a tone, letting you know that it has completed the search and is giving position data.

### **IMPORTANT!**

If the data shown in digital numbers on any screen is flashing, it means that data is invalid. **DO NOT RELY ON ANY NUMBER THAT ARE FLASHING!** Usually, this happens when the GlobalMap Sport™ has lost its lock on the satellites. The data that is flashing was the last known when the unit lost its navigational capability.

### **DO NOT NAVIGATE WITH THIS UNIT UNTIL THE DATA STOPS FLASHING!**

### **POSITION/NAVIGATION DISPLAYS**

The GlobalMap Sport™ has navigation, mapping, and windows group modes. These screens were designed to show data that is used most often. Many of the navigation, mapping, and windows screens can be customized to show data other than the ones chosen by the factory. See the Reprogram Groups section for more details.

The three default displays are shown on the next page. To change displays, simply press the MODE key. A screen similar to the one at right appears. Now press the up or down ar-

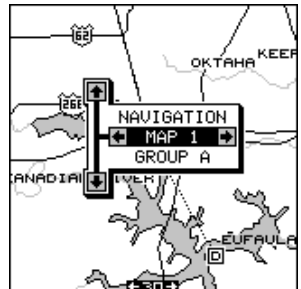

|                 |                   |
|-----------------|-------------------|
| TRK<br>23° MAG  | BRG<br>18° MAG    |
| GS<br>30.0 MPH  | UMG<br>29.9 MPH   |
| DIS<br>13.69 MI | XTE<br>L 0.02 MI  |
| ETE<br>0:27:27  | CLOCK<br>10:50:12 |

NAVIGATION



MAPPING  
(Map 1)

| SATELLITE INFO |     |     |     |      |     |
|----------------|-----|-----|-----|------|-----|
| CH#            | PPN | TRK | ELV | A2M  | SNR |
| 1              | 21  | S   | 60° | 110° | 0   |
| 2              | 21  | S   | 60° | 110° | 0   |
| 3              | 21  | S   | 60° | 110° | 0   |
| 4              | 21  | S   | 60° | 110° | 0   |
| 5              | 21  | S   | 60° | 110° | 0   |

| FIX   |      | SATS               |          |
|-------|------|--------------------|----------|
| FIX 1 |      | SATELLITES IN VIEW |          |
| HOP   | 1.78 | 1                  | 25 21 15 |
| GDP   | 3.32 | 20                 | 23 5     |
| PDP   | 2.96 |                    |          |
| UDP   | 2.37 |                    |          |
| TDP   | 1.50 |                    |          |

WINDOWS  
(Group A)

row keys to change modes. (The windows display is shown as "Groups". For example, Group A is the first windows group on the MODE menu.) When the desired display appears, press the EXIT key to clear the menu.

Note: For a list of abbreviations used on the displays, see the back of this manual.

### Navigation Screen

The navigation screen shows navigation information in digital displays. To view this screen, press the MODE key, then press the up arrow key until the black box surrounds the "Navigation" label. Now press the right arrow key. A screen similar to the one at right appears. Press the EXIT key to erase the mode menu.

|                 |                   |
|-----------------|-------------------|
| TRK<br>23° MAG  | BRG<br>18° MAG    |
| GS<br>30.0 MPH  | UMG<br>29.9 MPH   |
| DIS<br>13.69 MI | XTE<br>L 0.02 MI  |
| ETE<br>0:27:27  | CLOCK<br>10:50:12 |

This screen is composed of eight digital display boxes, showing your track (TRK) - direction of travel, ground speed (GS), and local time. The other boxes show navigation data when a waypoint is recalled. Although this is not a windows screen, all of the digital boxes can be changed. See the "Reprogram Groups" section for more information.

### Mapping

The GlobalMap Sport™ has a map of the world built inside. This map has the majority of its detail in southern Canada, the continental United States and Hawaiian islands, the Caribbean down to and including the Virgin Islands, all the way down to the northern coast of Honduras. It's displayed when the GlobalMap Sport™ is first turned on, with or without a map cartridge.





MAP 1

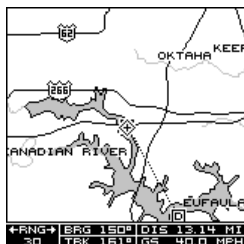

MAP 2



MAP 3

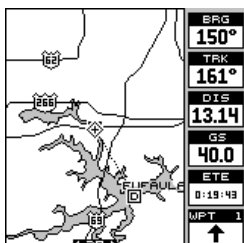

MAP 4

There are four different mapping screens available. Map screen number 1 shows by default. Your current position displays at the center of the screen by a cross surrounded by a flashing diamond.

To view the other mapping screens, press the MODE key. Press the up or down arrow key to move the black box to the "MAP 1" label. Now press the right arrow or left arrow key to select a different mapping screen. Maps 2, 3, and 4 (as shown above) have navigation data displayed using digital numbers. Press the EXIT key to erase the mode menu.

The digital displays on map 4 can be rearranged or changed to other displays. See the "Reprogram Groups" section for more information.

As you move, the map slides past your present position, which always remains at the center of the screen. A line extends from your position, showing the path you've taken.

Use the Z-OUT and Z-IN keys to enlarge or reduce the mapping area. If you have an IMS SmartMap™, its detail will usually begin showing when you zoom in to the 10 mile range.





If you zoom-in below the 5 mile range into an area not covered by a detail cartridge, the map data disappears, turning the screen into a plotter. If desired, you can turn the map off, turning the mapping screen into a plotter only on any range. To do this, press the MENU key, then press the up or down arrow keys until the black box is on the "Mapping" label. Press the left arrow key to turn the map off.

## Map Cursor

Pressing an arrow key while a map is on shows two dotted lines that intersect at your present position. These dotted lines are called a "cursor" and have a variety of uses.

You can move the cursor around the display by pressing the arrow keys in the direction you want it to move. This lets you view different areas of a map, away from your present position. When it's turned on, the zoom-in and zoom-out keys work from the cursor's position - not the present position, so you can zoom in on any detail, anywhere while navigating.

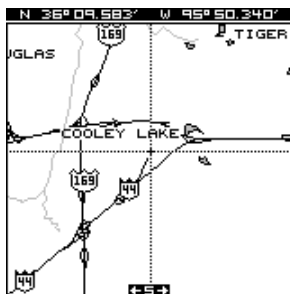

The latitude/longitude of the cursor shows in the box at the top of the screen whenever the cursor is activated.

To center the cursor on the map, press both the Z-IN and Z-OUT keys at the same time. Remove the cursor by simply pressing the EXIT key. The GlobalMap Sport™ moves the present position diamond to the center of the screen and erases the cursor.

The map cursor is also used to place and erase icons and waypoints.

## MAP MENUS

To view the map menus, first press the MENU key, then press the up or down arrow keys until the desired menu appears as shown below. When it does, press the right arrow key to view the items on the selected menu.

### PLOTTER OPTIONS

#### Plot Trail

The line extending from your present position is called a plot trail. The GlobalMap Sport™ lets you customize the plot trail with the following menu items. All of the items on the Plotter Options menu affect the plot trail.

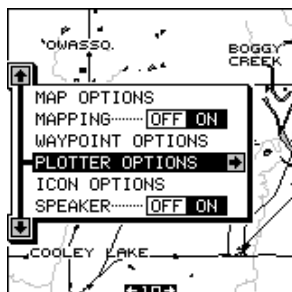

## Plot Trail Flashing

Since there can be many lines on the mapping display, it's helpful at times to make the plot trail flash. This makes it easier to see. To do this, move the black bar to the "Plot Trail Flashing" menu, then press the right arrow key. Press the EXIT key to return to the map. Repeat the above steps to turn the flashing off.

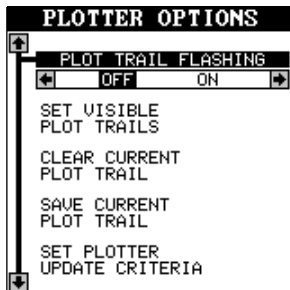

## Set Visible Plot Trails

The plot trail can be turned off, if desired. To turn it off, press the up or down arrow key until the "Set Visible Plot Trails" menu is surrounded by the black box. Now press the right arrow key. The screen at right appears.

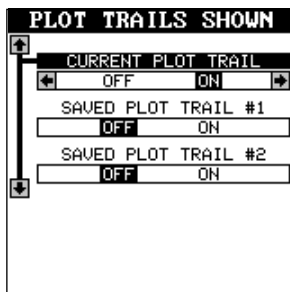

Use the up or down arrow keys to select the desired plot trail, then press the left or right arrow key. Press the EXIT key to return to the Plotter Options menu.

## Clear Current Plot Trail

To erase the plot trail extending from your present position, move the black box to the "Clear Current Plot Trail" menu, then press the right arrow key. A message box appears, asking you if you really want to erase the plot trail. Follow the directions on this message box. The GlobalMap Sport™ returns to the mapping screen after the message box clears.

## Save Current Plot Trail

You can save up to two plot trails in the GlobalMap Sport™'s memory. It saves these trails even if power is removed from the unit.

To save your current plot trail, move the black box to the "Save Current Plot Trail" menu using the arrow keys. Now press the right arrow key. A screen similar to the one at right appears.

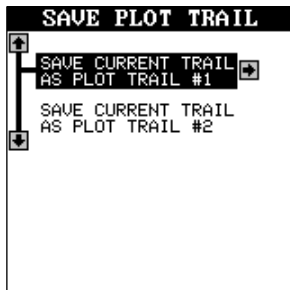

You can save the plot trail as #1 or #2. Move the black box to the desired plot trail number, then press the right arrow key. A message box appears asking you if you really want to save the trail. Follow the instructions in this box. The GlobalMap Sport™ re-

turns to the mapping screen after the message box clears. Your plot trail is now stored in memory.

To view your saved plot trail, see the “Set Visible Plot Trails” section.

### Set Plotter Update Criteria

The plotter places a dot on your trail as you move. It determines when to place a dot depending on two things: time and distance. By default, it places a dot every five seconds or every .1 of a mile, whichever comes first.

To change the update, move the black box (using the arrow keys) to the “Set Plotter Update Criteria” menu item, then press the right arrow key. A screen similar to the one at right appears.

To limit the update to time only, or distance only, press the left arrow key until the black box is on the desired setting.

Change the update rate by moving the black box to the “Plot Update Rate” menu, then press the left or right arrow keys until the desired time appears.

The distance update is changed in the same manner. Move the black box to the “Update Distance” menu, then press the left or right arrow keys until the desired distance appears.

When you have everything on this menu adjusted to the desired settings, press the EXIT key to enable them.

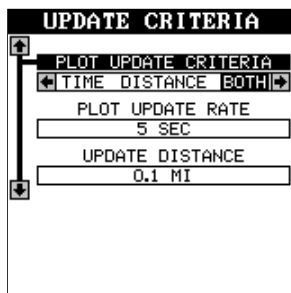

### MAP OPTIONS

This menu gives you a variety of options to customize your mapping screen. To use these options, first press the MENU key while a map is displayed. Next, press the up or down arrow keys the black box surrounds the “Map Options” label. Press the right arrow key to view this menu.



### Text Labels

Use this menu to turn the names on the map off or on. The default is "on". Press the left arrow key to turn them off.



### Map Boundaries

If you have a map cartridge plugged into the back of the GlobalMap Sport™, this feature will show the boundaries of the cartridge on the map. This lets you know the exact area covered by your cartridge. This example shows the boundaries of the Oklahoma - East Inland Mapping System cartridge.



### Fill With Gray

When the GlobalMap Sport™ is first turned on, all water is filled with gray to distinguish it from land, which is clear. To make the land fill with gray and water remain clear, press the down arrow key until the "Fill With Gray" menu is surrounded by the black box, then press the left arrow key. Press the EXIT key to return to the mapping screen.

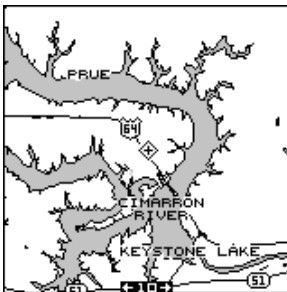

FILL WITH GRAY - WATER

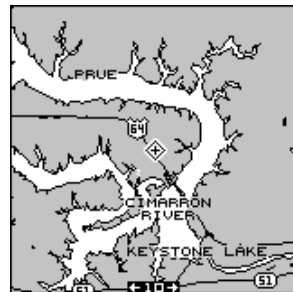

FILL WITH GRAY - LAND

You'll generally want to fill water with gray when you're using the GlobalMap Sport™ on land and fill land with gray when you're using it on the water.

## Track Up Mode

Normally, the GlobalMap Sport™ shows the map with north always at the top of the screen. This is the way most maps and charts are printed on paper. This is fine if you're always travelling due north. What you see to your left corresponds to the left side of the map, to your right is shown on the right side of the map, and so on.

However, if you travel any other direction, the map doesn't line up with your view of the world.

To correct this problem, the GlobalMap Sport™ has a track-up mode that rotates the map as you turn. Thus, what you see on the left side of the screen should be to your left, and so on.

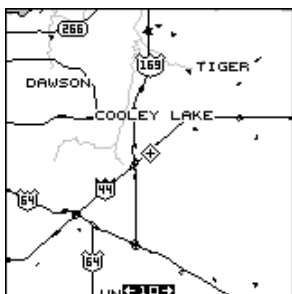

NORTH-UP

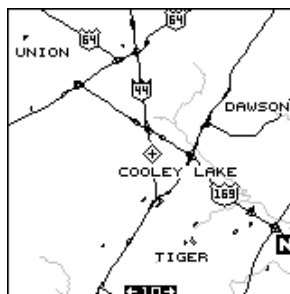

COURSE-UP

In the above example, we're travelling southwest on Interstate 44. In the north-up view, the present position indicator appears to move towards the lower left corner of the display. In the track-up view, the present position moves towards the top of the display. A "N" shows to help you see which direction is north when the track-up mode is on.

(Note: the track-up mode does not work when the unit is zoomed-in on a C-Map cartridge.)

To select the track-up mode, press the up or down keys to move the black box to the "Track Up Mode", then press the right arrow key to turn it on. Press the EXIT key to return to the mapping screen.

## Detail Cartridge

The GlobalMap Sport™ can use either Lowrance™ Inland Mapping System cartridges or Lowrance C-Map cartridges. You can have one of each in the unit at the same time, however you can only use one or the other.

To switch between Lowrance and C-Map cartridges, press the up or down arrow keys until the "Detail Cartridge" menu is surrounded by the black box, then press the left or right arrow keys to select the desired cartridge. Press the EXIT key when you're finished.

## ICONS

The GlobalMap Sport™ has fifteen symbols or "icons" available. These icons can be placed anywhere on the mapping screens. These can be used to mark fishing spots, boat ramps, rest stops, airports, or whatever. You can place an icon at your present position, or at the cursor location.

Before you can view icons on the map, you must first turn the icons on. To do this, first press the MENU key, then use the up or down arrow keys to move the black box to the "ICON OPTIONS" box. Now press the right arrow key. The screen shown at right appears. The black box is on the "Icon Symbols" menu. Press the right arrow key. This turns the icons on. Press the EXIT key to erase this menu and return to the mapping screen.

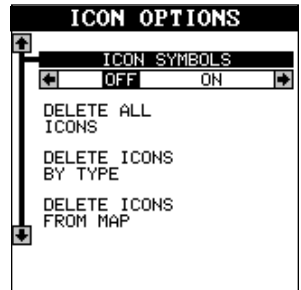

## Place Icon - Present Position

To place an icon at your present position, simply press the ENT key. The screen shown below appears. Use the arrow keys to move the black box to the desired icon. Now press the ENT key. The mapping screen appears with the icon you selected placed at your position when you first pressed the ENT key, not your present position.

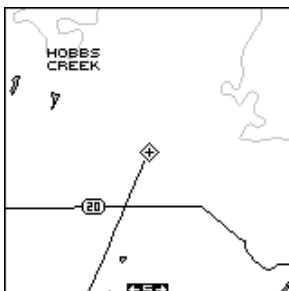

MAP - BEFORE PLACING  
ICON

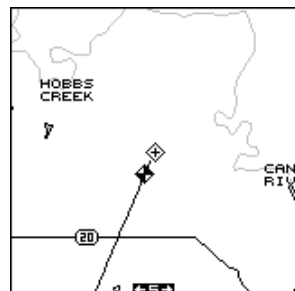

MAP - AFTER PLACING  
ICON

## Place Icon - Cursor Location

To place an icon at cursor's location, first use the arrow keys to move the cursor to the position that you want to place the icon. Next, press the ENT key. Now select the desired icon using the arrow keys. When it's selected, press the ENT key. The mapping screen re-appears with the icon at the cursor's location. Press the EXIT key to erase the cursor.



MOVE CURSOR TO  
LOCATION



PRESS ENT, SELECT  
ICON, PRESS ENT

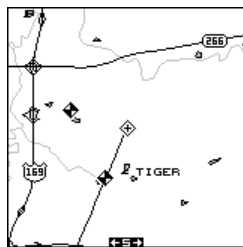

PRESS EXIT TO ERASE  
CURSOR

## Erase Icons

To erase an icon from the screen, first press the MENU key, then select the "Icon Options" menu as shown at the top of the previous page.

There are three methods used to erase icons from the screen. You can delete all of the icons, regardless of their position on the display, delete all of the icons of a certain type, or selectively erase individual icons.

To erase all of the icons, move the black box to the "Delete All Icons" menu, then press the right arrow key. A message appears, asking you if you want to delete all icons. Press the left arrow key to erase them. The unit returns to the mapping screen with all icons deleted.

To remove only icons of a certain type, move the black box on the Icon Options menu to the "Delete Icons By Type" label. Press the right arrow key. The icon selection menu appears. Use the arrow keys to move the black box to the icon style that you wish to erase. Press the ENT key when you're ready to erase the icons. A message appears, asking you if you want to delete the icons of that type. Press the left arrow key to erase them. The unit returns to the mapping screen with all icons of the type you selected erased.

To remove only certain icons, move the black box on the Icon Options menu to the "Delete Icons From Map" label. Press the right arrow key. The unit returns to the mapping screen with the cursor centered on your present position. Use the arrow keys to move the cursor to the icon on the map

that you wish to erase. Press the ENT key when you're ready to erase the icon. A message appears, asking you if you want to delete that icon. Press the left arrow key to erase it. If you wish to delete another icon, move the cursor over it and press the ENT key. When you're finished, press the EXIT key to erase the cursor.

## WINDOWS

The windows feature gives you over 45 different displays that you can arrange in 15 different groups. This lets you customize the unit to your own situations.

To use the windows feature, press the MODE key, then press the up or down arrow keys until the black box surrounds the "GROUP A" label as shown below. Windows has 15 different pre-programmed groups: A through O. Group "A" is visible in the background when you switch to the windows groups. To view each group, simply press the right or left arrow key while the mode menu is showing. Each group shows in the background as you press the arrow keys.

| SATellite INFO |     |     |     |     |     |
|----------------|-----|-----|-----|-----|-----|
| CHN            | PRN | TRK | ELV | AZM | SNR |
| 1              | 28  | T   | --- | --- | 44  |
| 2              | 27  | T   | --- | --- | 45  |
| 3              | 29  | T   | --- | --- | 43  |
| 4              | 2   | T   | --- | --- | 44  |
| 5              | 19  | T   | --- | --- | 48  |

|      |      |                    |  |
|------|------|--------------------|--|
| FIX  |      | SATellites IN VIEW |  |
| HDOP | 1.35 |                    |  |
| GDOP | 2.74 |                    |  |
| PDOP | 2.46 |                    |  |
| VDOP | 2.06 |                    |  |
| TDOP | 1.21 |                    |  |

When you see the group you want to use, simply press the EXIT key to erase the mode menu.

## Special Windows

Although most of the windows used in the GlobalMap Sport™ are self-explanatory, there are several windows that have special features or can be used in unique ways. The following section describes these windows.

### Satellite Information Screen (Group A)

This screen shows technical information about the status of the GPS receiver. The receiver has five channels. Data for each channel is shown at the top of the display. The channels are numbered one through five on the left side of the screen. Every satellite in the constellation has a number assigned to it, called the PRN. The TRK column shows a "T" if the channel is tracking the satellite, or a "S" if it is searching for it. ELV is the elevation of the satellite above the horizon; AZM is the azimuth, or direction from your location. SNR is the signal-to-noise ratio. The higher the SNR, the better.

| SATellite INFO |     |     |     |      |     |
|----------------|-----|-----|-----|------|-----|
| CHN            | PRN | TRK | ELV | AZM  | SNR |
| 1              | 28  | T   | 25° | 44°  | 44  |
| 2              | 27  | T   | 40° | 312° | 45  |
| 3              | 29  | T   | 18° | 170° | 43  |
| 4              | 2   | T   | 24° | 264° | 44  |
| 5              | 19  | T   | 72° | 340° | 48  |

|      |      |                    |          |
|------|------|--------------------|----------|
| FIX  |      | SATS               |          |
| FIX  | 9    | SATellites IN VIEW |          |
| HDOP | 1.35 | 19                 | 31 18 27 |
| GDOP | 2.74 | 28                 | 2 29     |
| PDOP | 2.46 |                    |          |
| VDOP | 2.06 |                    |          |
| TDOP | 1.21 |                    |          |

If you look at row one in the satellite info screen above, channel 1 is



tracking satellite number 28. The satellite's elevation is 25 degrees above the horizon and it's location is 44 degrees. It's SNR is 44, which is good.

The FIX numbers in the lower left corner of the screen show the quality of fix. If the FIX is 9, then it's the best you can get. A FIX of 1 is the worst. The DOPS display beneath the fix quality show you the "Dilution of Precision" for the horizontal (HDOP), geometric (GDOP), position (PDOP), time (TDOP), and vertical (VDOP). The GDOP is a combination of HDOP, VDOP, and TDOP. The smaller the DOP's value, the better. The receiver selects satellites based on the GDOP value, therefore, it always tries to use satellites that have good DOP values. These depend on the azimuth and elevation of the satellite, and any ground based obstructions.

### Steering Screen (Group F and O)

The steering screen shows a pictorial view of your course and the distance to the side of the desired track to a waypoint. You must recall a waypoint to use the steering screen.

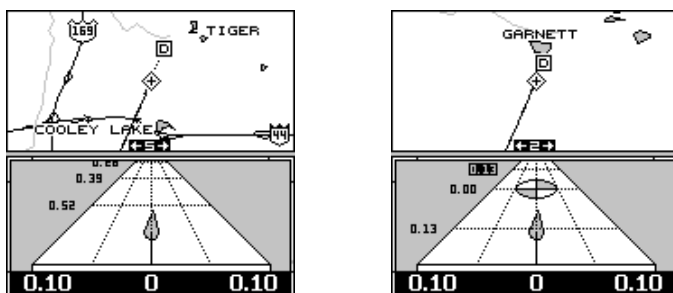

Your present position is shown by a pointer near the center of the steering screen as shown in group "O", above. It shows the direction you're heading in relation to the waypoint. If you keep the pointer aimed at the top of the display and centered in the middle, you'll reach the waypoint in the shortest straight line.

The solid line extending from the pointer is the path you've taken. To travel directly to a waypoint, try to keep the pointer on the center line. As you approach the waypoint, a circle descends from the top of the steering screen. This represents the waypoint.

Small numbers on the left side of the steering screen show the distance from your present position to the recalled waypoint. If the numbers are surrounded by a black box, then that is the distance *past* the waypoint.

The large numbers at the bottom of the screen show the distance you're

off course to the right or left. This is called "Cross Track Error". For example, if the pointer is halfway between the center line and the left outside line, and the range is 0.10 miles, then you are off course to the left of the desired path by 0.05 miles. In other words, your cross track error is left 0.05 miles. You can change the range by changing the cross track error (XTE) alarm. See the GPS alarms section for more information.

### Dual Mapping

The windows feature gives you the capability to have more than one map on the display at one time. For example, group "M" shown at right has two half-screen maps, side-by-side. Both of these maps are completely independent of each other. In other words, you can zoom in or out, set options, and other functions on one map, without affecting the other.

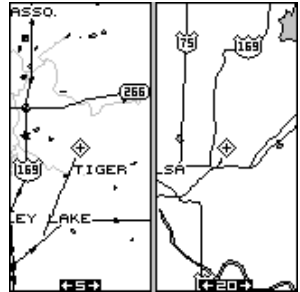

When you press the menu, zoom in or out, or enter keys, a message appears asking you which display you want to affect. On the screen shown at right, the menu key was pressed. The unit wants to know which map you want to change. Press the left arrow key for the left map, the right arrow key for the right map. The main menu then appears.

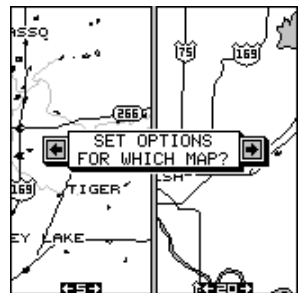

### CLOCK

Whenever a clock is showing on a display, new items appear in the list when you press the MENU key. These items let you set the clock's time, set alarms, and change the unit of measure. The clock and timers can be used on windows, mapping, or the navigation mode.

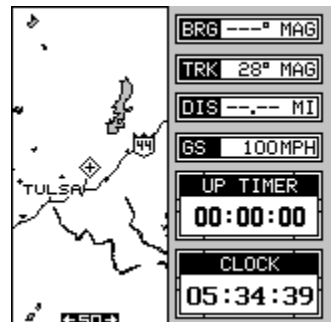

### Clock Set

If the time shown on the clock display is not your local time, change it using the "Clock Set" function. To do this, press the MENU key, then press the up or down arrow keys until the black box is on the "Clock Set" label. Press the right arrow key. A screen similar to the one at the top of the next page appears.

Using the right and left arrow keys, move the black box to the first number in the time that you want to change. Now press the up or down arrow keys until the desired number shows. Continue until the time shown in the display is correct, then press the ENT key. The unit returns to the navigation, mapping, or windows display with the new time showing.



### Clock Hours

Normally, the time shows in the twelve hour format (a.m./p.m.). To change it to 24-hour format, press the MENU key, then select the “CLK HRS” label. Now press the right arrow key to change it to 24, then press the EXIT key.

### Clock Alarm

You can set an alarm (that works just like an alarm clock), by using the “Clock Alarm” menu. To set this alarm, press the MENU key, then move the black box to the “Clk Alm Set” label. Press the right arrow key. A screen similar to the one below appears. Using the right and left arrow keys, move the black box to the first number in the time that you want to set. Now press the up or down arrow keys until the desired number shows. Continue until the time shown in the display is correct, then press the ENT key. The unit returns to the navigation, mapping, or windows display.



To turn the alarm on, press the MENU key, then select the “CLK ALM” menu. Press the right arrow key. The alarm is now activated.

When the alarm goes off, an audible tone sounds along with a flashing message on the screen. Press the EXIT key to turn the alarm off.

Note: The GlobalMap Sport™ must be on in order for the alarms to work. In other words, if you set the alarm to go off at 7:00 a.m., then the GlobalMap Sport™ will have to be on at 7:00 a.m., also.

## TIMERS

The GlobalMap Sport™ has two timers built in. One is a count-down timer and the other is a count-up timer. The count-down timer counts down from the time you put in to zero. The count-up timer starts at zero and counts up to the time you entered.

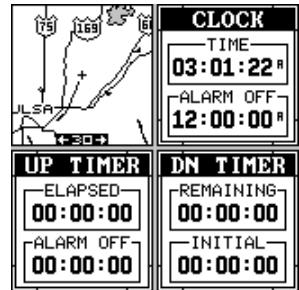

To set either timer, first switch to a screen that is showing the timer that you want to use. Next, press the MENU key, then move the black box to the desired timer set menu. In this example, we're setting the count-down timer. Now press the right arrow key. A screen similar to the one below appears.

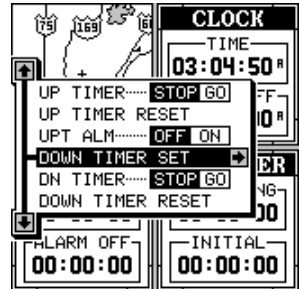

Using the right and left arrow keys, move the black box to the first number in the time that you want to set. (The time is in hours, minutes, and seconds) Now press the up or down arrow keys until the desired number shows. Continue until the time shown in the display is correct, then press the ENT key. The unit returns to the navigation, mapping, or windows display.

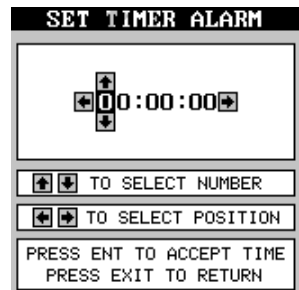

To start the timer, press the MENU key, then move the black box to the "Dn Timer STOP/GO" label. Press the right arrow key to start the timer. The timer continues counting until you stop it. If you turn the up timer's alarm on (press the right arrow key when the black box is on the (Up ALM...Off/On label), it will sound a tone when it reaches the time you entered in the up timer set menu. Press the EXIT key to silence the alarm.

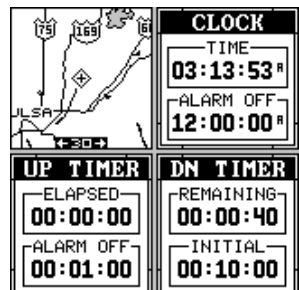

You can reset either alarm to the time you originally set by pressing the MENU key, then moving the black box to either the “Up Timer Reset” or “DN Timer Reset” label, then press the right arrow key.

**REPROGRAM WINDOWS GROUPS**

All of the 15 windows groups can be customized. The changes you make to the groups will remain in memory, even if all power is removed from the unit. You can, however, return the groups to the factory settings from the “Preset Groups” menu.

Before you reprogram a group, you may wish to view all of the possible windows that make up the windows groups. To do this, press the MENU key while a windows group is showing. Now move the black box to the “View Windows” label and press the right arrow key. The first window appears along with its description. Continue pressing the right arrow key to see more windows. When you’re finished, press the EXIT key.

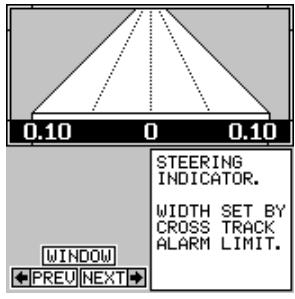

To customize a group, first switch to a windows group. It doesn’t have to be the group you want to customize. Next, press the MENU key, then press the up or down arrow key until the “Re-program Groups” menu is surrounded by the black box. Press the right arrow key. A screen similar to the one shown at right appears.

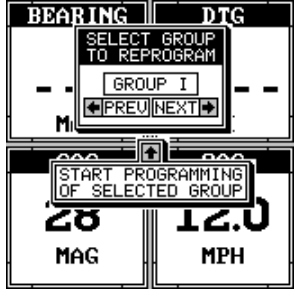

You’ll see the group selection menu at the top of the screen. Using the left or right arrow keys, choose the group you want to change. When the desired group letter is showing in the box (and in the background), press the up arrow key to change it. A screen similar to the one at right appears.

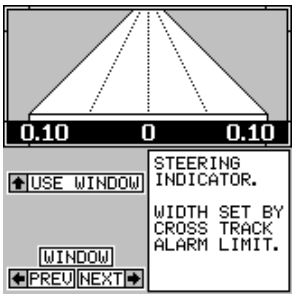

The first window appears on this screen. A description of the window appears in a box on this screen, also. If you wish to use it, simply press the up arrow key. The unit flashes a message on the screen, telling you it’s

adding the new window to the group. When it's finished, it returns to the window selection menu. You can now press the right or left arrow keys to select the next window in the group.

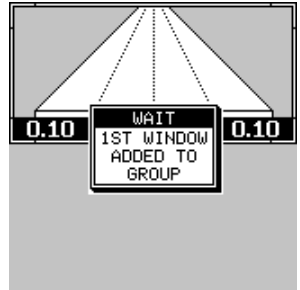

When you're finished selecting windows *before* filling the group with windows, press the EXIT key. If you fill the group with windows, the unit will automatically leave the reprogram groups menu after the last window is selected.

**Note:**The digital boxes on the navigation and map #4 screens can also be re-programmed. Follow the same steps show above to program the navigation and map screens. (The menu label is called "Reprogram Boxes" for the navigation and map screens.)

## RESET GROUPS

To return all groups to their factory defaults, press the MENU key, then press the up or down arrow keys until the black box is on the "PRESET GROUPS" menu. Now press the right arrow key. All groups are now reset to their factory settings.

## BACKLIGHT

The GlobalMap Sport's™ display and keyboard have lights that can be turned on for night use. Although there is a menu item "Backlight", the easiest way to turn the lights on is to simply press the PWR key. To turn them off, press the PWR key again.

If the unit is operating from the battery pack, it automatically turns the lights off after 30 seconds. This helps conserve battery power. The time is adjustable from 5 seconds to 240 seconds. Press the PWR key to turn the lights on after the unit turns them off.

To change the backlight's delay time, press the MENU key, then press the up or down arrow keys until the "Delay" menu is surrounded by the black box. Now press the left or right arrow key until the desired time appears on the menu. Press the EXIT key when you're finished.

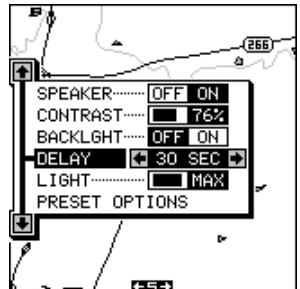

The backlights brightness is also adjustable. To do this, press the MENU key, then press the up or down arrow keys until the "Light" menu is surrounded by the black box. Now press the left or right arrow key until you have the lights at the desired level. Press the EXIT key when you're finished.

## UNITS OF MEASURE

The GlobalMap Sport™ can show its data in many different formats. For example, distance can be displayed in statute miles (MI), nautical miles (NM), or kilometers (KM).

The following can be changed on the Units of Measure menu:

- Distance ..... miles, nautical miles, kilometers
- Speed ..... miles per hour, knots, kilometers per hour
- Bearing ..... magnetic, true
- Altitude ..... feet, meters
- Clock ..... 12-hour (a.m.-p.m.), 24 hour
- Position Format ..... degrees, minutes, and tenths of a minute  
degrees, minutes, seconds  
UTM

To change a setting on this menu, move the black box to the desired selection, then press the left or right arrow key. You can change one or all of the settings on this page. When you're finished, press the EXIT key.

Note: See the following on the position format and UTM's.

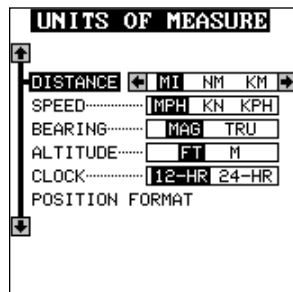

## Position Format

To change the position format, move the black box to the "Position Format" label on the Units of Measure menu, then press the right arrow key. A screen similar to the one below appears.

The GlobalMap Sport™ can show the position in degrees, minutes, and hundredths of a minute (36 28.700') or degrees, minutes, and seconds (36 28' 40.9"). It can also show position in UTM's or Universal Transverse Mercator projection.

UTM's are marked on USGS topographic charts. This system divides the Earth into 60 zones, each approximately 6 degrees wide in longitude. Their unit of measure is in meters. For example, 15 N means that the position shown to the right of the "N" is in grid 15, and it's north of the equator.

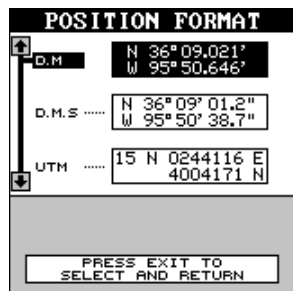

Press the up or down arrow keys to move the black box to the desired position format. Press the EXIT key to both select the format and erase the position format menu.

## TRACK HOLDING

When using a GPS receiver at low speeds, it can have trouble determining your course over ground, or direction you're travelling. This is due in large part to SA, or selective availability. SA is small inaccuracies purposefully put into the GPS satellite's signal by the government. This causes wide variations in the track display and other navigation displays when using the unit at slow speeds.

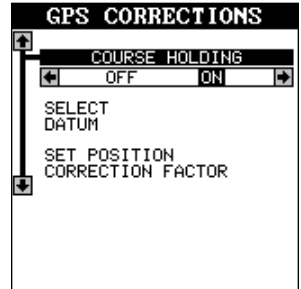

If you're using the GlobalMap Sport™ without DGPS at speeds below 10 miles per hour, a track holding feature begins slowing the update of your course over ground. At 3 mph, it locks the track display to the last known heading. With DGPS, it begins at 5 mph and locks at 1 mph.

(Note: This only affects the map when it's in the track-up mode. It always affects the navigational displays.)

To turn the track holding feature off, press the MENU key, then move the black box to the "GPS Corrections" label and press the right arrow key. The screen shown at right appears. Press the left arrow key to turn track holding off. Press the EXIT key to erase this menu.

## DATUM

Maps and charts are based on a survey of the area that's covered by the map or chart. These surveys are called "Datums". Maps that are created using different datums will show the same latitude/longitude in slightly different locations.

All datums are named. The GPS system is based on the WGS-84 datum, which covers the entire world. Other datums may also cover the entire world, or just a small portion. By default, the GlobalMap Sport™ shows your position on the map using the WGS-84 datum. However, it can show your position using one of 99 different datums.

To change the datum, first press the MENU key, then move the black box to the "GPS Correction" label. Press the right arrow key. Using the up or down arrow keys, move the black box to the "Select Datum" label. Now



press the right arrow key again. A screen similar to the one at right appears.

The black box is resting on the WGS-84 label. To change it, simply press the up or down arrow keys until the black box is on the desired datum, then press the ENT key. This selects the datum and erases the select datum menu. The GlobalMap Sport™ is now using the datum you selected.



### PCF (Position Correction Factor)

Another method used to make your display match a chart or map is called “PCF” or Position Correction Factor. This unit gives you the capability to move or offset the position shown on the display to match one on the chart. The unit will add this offset to all position and navigation displays at all times.

Remember, the position error on any radio navigation system is very dynamic and the PCF offset should never be used in an attempt to cancel the error.

In general terms, PCF should only be used if your map indicates what the possible error is. **PCF should always be reset to zero when you're finished with the chart.**

For example, suppose you are stopped at a location that is accurately marked on a chart. Your unit shows a longitude position that is .244 minutes east of the one on the chart and .047 minutes north latitude. Using the PCF feature, you can make the GlobalMap Sport™ match the chart you're using. If you move, the unit will continuously add the change to all position, navigation, and mapping displays. This makes it more closely match the datum used by the chart. For this reason, you should be careful when entering the PCF offset. It's saved in memory and doesn't change when the unit is turned off. However, resetting the unit does erase the PCF offset.

To set the PCF offset, first press the MENU key, then press the up or down arrow keys until the black box is on the “GPS Corrections” label. Press the right arrow key. Now move the black box to the “Set Position Correction Factor” label and press the right arrow key. The screen shown at right appears.



Now enter the correction for your location. Remember, this is the difference between the location shown on the present position display and the position shown on the chart. In this example, we entered 0 degrees, 0.047 minutes north latitude and 0 degrees, 0.244 minutes east longitude. That is the difference between the present position shown by the GlobalMap Sport™ and the one on our chart.

After you've entered the latitude/longitude correction, press the ENT key to accept it. The GlobalMap Sport™ erases the PCF entry screen and returns to the navigation or mapping screens with the correction factor applied.

### SYSTEM INFO

The system information screen shows the release date and the version number of the code stored inside the GlobalMap Sport™. To view this screen, press the MENU key, then press the up or down arrow keys until the "System Info" menu is surrounded by the black box. Now press the right arrow key. A screen similar to the one below appears. Press the EXIT key when you're finished reading this screen.



### GPS COMMANDS

The GPS Commands menu has five sub-menus that affect the GPS receiver. From these menus you can turn the simulator on or off, set the update rate, initialize the GPS receiver, do a self-test on the receiver, and do a cold-start. (Note: The "Initial GPS Module" is covered in the "Getting Started" section in the front of this manual.

To view these menu items, press the MENU key, then press the up or down arrow keys until the "GPS Commands" menu appears. Press the right arrow key. A screen similar to the one at right appears.



### GPS Simulator

A simulator is built into the GlobalMap Sport™ that runs a pre-set course off the Florida coast near Miami. When the present position reaches the end of the course, the plot trail is erased and the simulator starts over. You can use nearly all of the unit's features - even save and recall waypoints.

To turn the simulator on, press the up or down arrow keys until the “GPS Simulator” menu is surrounded by the black box. Now press the right arrow key. Press the EXIT key to erase this menu.

Note: Your plot trail will be erased when you turn the simulator on or off.

### GPS Update Rate

Changing the update rate conserves battery power and lengthens the battery life. The update rate is the length of time it takes the receiver to send data to the display. In other words, normally the receiver sends position data out once every second. You can reduce that time to once every five seconds. However, slowing the update rate also makes it harder to use this product at slow speeds, such as hiking or sailing. The faster the update rate, the better the unit can respond to changes in direction or speed.

If you wish to change the update rate, simply move the black box to the “GPS Update Rate (SEC)” menu, then press the left or right arrow key to move the black box over the desired rate: 1, 2, 3, 4, or 5 seconds. Press the EXIT key to activate your selection.

### Execute GPS Self Test

If you suspect a problem with the GPS receiver, or just wish to test it, move the black box on the GPS Commands menu to the “Execute GPS Self Test” label, then press the right arrow key. A screen similar to the one at right appears after several seconds. Messages at the bottom of the display will tell you if the unit passed the self-test, or failed. If the unit fails the self-test, contact the Lowrance customer service department.

| SELF TEST RESULTS      |      |
|------------------------|------|
| BIT SUMMARY            | 0000 |
| LOW ORDER RAM          | FFFF |
| HIGH ORDER RAM         | FFFF |
| PREPROCESS TEST        | 0000 |
| PREPROCESS RAM         | FFFF |
| MULTI INTERFACE        | 0100 |
| VCO TEST               | 0000 |
| SIGNAL INJ.            | 0000 |
| SOFTWARE VERSION       | 5.75 |
| <b>RECEIVER PASSED</b> |      |

### Execute GPS Cold Start

When the GlobalMap Sport™ is turned on for the first time “out of the box”, it automatically sends a “cold-start” message to the GPS receiver. You can also send a cold start message to the receiver at any time.

If the unit can't lock on to the satellites using the data you've given it, or if it has trouble finding the satellites, perhaps it is using the wrong data. This can happen if you've entered the wrong data by accident when initializing the receiver. For example, if you entered east longitude instead of west. Or if you've moved a long distance with the unit turned off.

To send a cold start message to the receiver, move the black box on the GPS Commands menu to the "Execute GPS Cold Start" menu, then press the right arrow key. A message appears, asking you if you really want to do a cold start. Follow the instructions on this message page.

The unit will begin searching for the satellites. It can take as long as 15 minutes for it to lock on to the necessary satellites, but it usually takes much less time. Remember, when it does, your local time and possibly date can be wrong. Use the method shown in the initialization section at the front of this manual to change them, if needed. Once this is done, an internal clock will keep the correct time, even when the unit is turned off. The GPS system updates this clock when the unit is locked on to the satellites.

## **GPS ALARMS**

The GlobalMap Sport™ has three different alarms. An arrival alarm sounds a warning tone when you cross a preset distance from a waypoint. For example, if you have the arrival alarm set to .1 mile, then the alarm will sound when you come within .1 mile of the recalled waypoint. The cross track error alarm (XTE) sounds a warning when your track drifts too far to the right or left of the line to the waypoint. For example, if the alarm is set to .1 mile, then the alarm will sound if you drift .1 of a mile or more to the right or left of the line to the waypoint. The anchor alarm sounds a warning when you drift outside of a preset radius. Again, using the .1 mile as an example, if you're anchored and the boat moves more than .1 of a mile, the alarm will sound.

### **Important Alarm Notes:**

**Anchor Alarm** - Since civilian users don't receive the accuracy given to military users, the anchor alarm may sound even when you're sitting still. This typically happens when using small (less than .05 mile) anchor alarm ranges. If you have a DGPS beacon receiver connected to the GlobalMap Sport™, smaller ranges may be useable.

**Arrival Alarm** - If you set the arrival alarm's distance to zero (0), and you run a route (see the routes section), the GlobalMap Sport™ may not show navigation data to the next waypoint, once you arrive at the first one. If you use the routes feature, never set the arrival alarm to zero.

To use any of these alarms, first press the MENU key, then select the "GPS ALARMS" menu. A screen similar to the one shown at the top of the next page appears. Press the up or down arrow key to move the black box to the desired alarm, then press the right arrow key to turn it on.

To adjust the alarm's distance, move the black box to the "DST" menu item, then press the left or right arrow keys to increase or decrease the alarm's distance.

When you're finished adjusting the alarms, press the EXIT key to erase this menu.

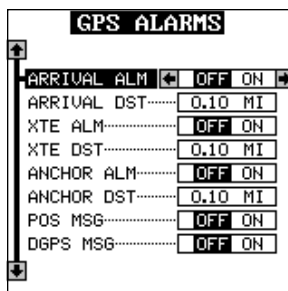

## MESSAGES

At the bottom of the GPS Alarms menu is position (POS) and DGPS message selections. The position message (shown below) appears for a few seconds whenever the GlobalMap Sport™ locks onto the satellites and shows a position. It also appears when the unit loses the lock onto the satellites and cannot navigate.



The DGPS message appears whenever the unit begins or stops using DGPS data to help determine your position.

To turn on either message, select the GPS Alarms menu from the main menu, then move the black box to the desired message and press the right arrow key to turn it on. Press the EXIT key to erase this screen.

## NMEA / DGPS

The GlobalMap Sport™ transmits data through the data port in the back of the unit using NMEA 0183 format, version 1.5 or 2.0. This data is used by other electronic devices such as autopilots for position and steering information.

DGPS on the other hand, is a data input. DGPS is an acronym for Differential Global Positioning System. Currently, it relies on a system of ground-based transmitters that send correction signals to small DGPS receivers. These receivers connect to the GlobalMap Sport™ through the data port. DGPS gives you more accurate positions than is otherwise possible.

See the sample wiring diagrams on the next page for general wiring procedures. You'll need a NDC-1 adapter cable for your GlobalMap Sport's™ data port. Read your other product's owner's manual for more wiring information.

## GLOBALMAP SPORT™ TRANSMITTING NMEA DATA TO ANOTHER DEVICE

NDC-1 TO GLOBALMAP SPORT™

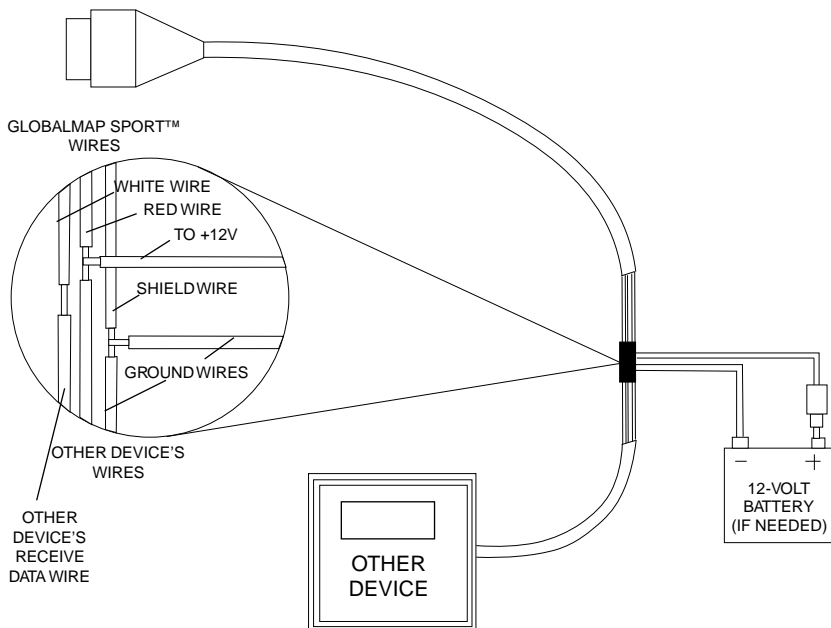

(Note: Connecting power to the GlobalMap Sport™ through the NDC cable as shown in the diagrams is optional. However, the shield wire must still be connected to ground.)

Once the cables are wired, turn the GlobalMap Sport™ on, press the menu key, and select the NMEA / DGPS menu. A screen similar to the one at right appears.

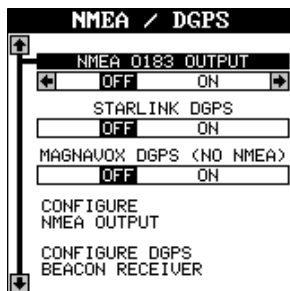

### NMEA

To turn the NMEA output on, move the black box to the "NMEA 0183 OUTPUT" menu, then press the right arrow key. If your other equipment works, then no setup will need to be performed. If your other equipment doesn't recognize the NMEA data being sent by the GlobalMap Sport™ and the wiring is correct, then you may need to change the NMEA or the serial communication settings.

## GLOBALMAP SPORT™ RECEIVING DATA FROM A DGPS RECEIVER

NDC-1 TO GLOBALMAP SPORT™

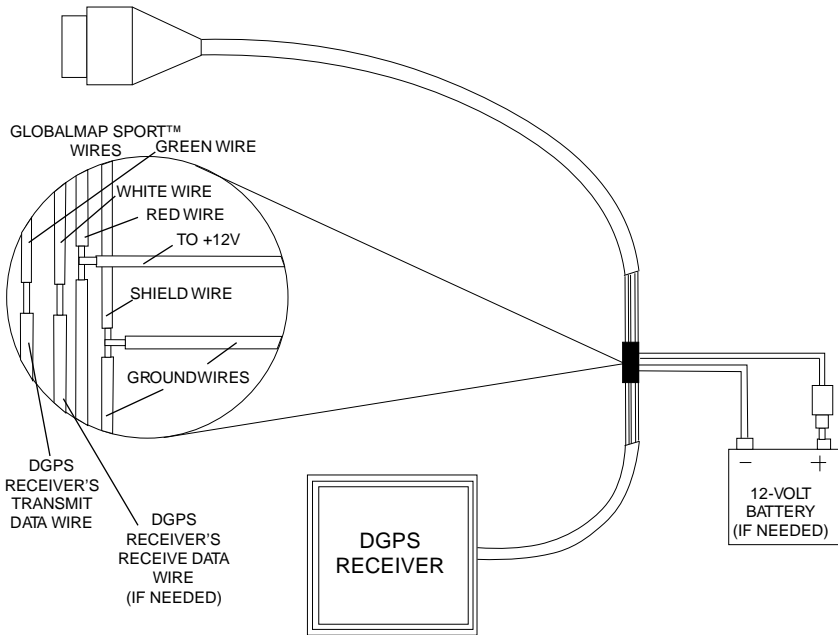

### Configure NMEA Output

Press the down arrow key until the black box is on the "Configure NMEA Output" menu, then press the right arrow key. A screen similar to the one below appears.

### NMEA 0183 Version

There are two versions of the NMEA data, 1.5 and 2.0. If your other equipment requires 2.0, press the right arrow key to select it.

### GLL Sentences - RMC/RMB Sentences - APB Sentences

Some equipment requires different sentence. The GlobalMap Sport's™ default setting for these sentences is on. In other words, it automatically sends these sentences when NMEA is turned on. To turn any of these off, move the black box to the desired menu and press the left arrow key. Press the EXIT key when everything on this screen is the way you want it.

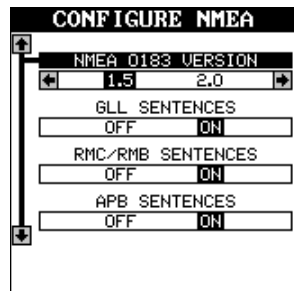

## DGPS

The GlobalMap Sport™ will recognize Starlink and Magnavox DGPS receivers. If you have either one of these receivers, simply move the black box on the NMEA / DGPS menu to the “Starlink DGPS” or “Magnavox DGPS” menus and press the right arrow key to turn it on. (Note: If you have a Magnavox DGPS receiver connected, the GlobalMap Sport™ can't send NMEA data.) With the exception of serial communications, typically no other setup needs to be made with these receivers.

If you have any other Magnavox or Starlink compatible DGPS receiver connected to the GlobalMap Sport™, you may need to change the settings. To do this, first select the NMEA / DGPS menu from the main menu, then move the black box to the “Configure DGPS Beacon Receiver” label and press the right arrow key. A screen similar to the one at right appears.

The screenshot shows a menu titled "CONFIGURE DGPS". It has a vertical bar on the left with an up arrow at the top and a down arrow at the bottom. The menu items are:

- FREQUENCY (KHZ) with a value of 293.0 and left/right arrow keys.
- BIT RATE (BPS) with a value of 50.
- STARLINK AUTO MODE with options OFF and ON, where ON is selected.

These menus select the beacon receiver's frequency and bit rate (in bits per second). If you are using a Starlink receiver, turning the auto mode on causes the GlobalMap Sport™ to auto-detect the frequency and bit rate.

To change one of these settings, simply move the black box to the menu item you wish to change, then press the right or left arrow key until the desired number appears. Press the EXIT key when you're finished.

## SERIAL COMMUNICATIONS SETUP

To set the data port, press the MENU key, then press the up or down arrow key until the black box is on the “Serial Com Setup” menu. Press the right arrow key. The screen shown below appears.

Check your DGPS receiver's manual for the proper data settings. Move the black box to the menu item you need to change. Press the left or right arrow keys to change them. The serial port defaults are 4800 baud, no parity, and 8 data bits. Press the EXIT key to erase this menu.

The screenshot shows a menu titled "SERIAL COM SETUP". It has a vertical bar on the left with an up arrow at the top and a down arrow at the bottom. The menu items are:

- BAUD RATE with a value of 9600 and left/right arrow keys.
- PARITY with options EVEN, ODD, and NONE, where NONE is selected.
- DATA BITS with values 7 and 8, where 8 is selected.



## NAME

You can personalize your GlobalMap Sport™ by entering your name or social security number or any i.d. you desire.

To enter a name, first press the MENU key, then move the black box to the “Name Input” menu. Press the right arrow key. The screen shown at right appears.



### IMPORTANT!

The name or number you save is written into the GlobalMap Sport's™ permanent memory. You won't be able to change it once you enter it, unless you return the unit to the factory. Make certain the name or I.D. is exactly the way you want it before pressing the ENT key!

This is the first name entry screen. Press the up or down arrow keys until the first letter appears that you want to use. When it does, then press the right arrow key to move to the next letter. Continue this process until the I.D. is complete. You can press the WPT key to completely erase all of the characters you entered and start over, if you need to. Pressing the EXIT key erases this screen without accepting any input. When the first name is correct, press the ENT key.

Now enter your last name, using the same method as shown above. When it's the way you want it, press the ENT key. You I.D. is saved in permanent memory.

To see your I.D., see the System Information screen. Your identification will be permanently placed on this screen.

## RESET OPTIONS

To return the GlobalMap Sport™ to its original factory settings, press the MENU key, then press the up or down arrow keys until the “Preset Options” menu is surrounded by the black box. Now press the right arrow key. A message appears, asking if you want to restore the original options. Press the left arrow key if you do, the right arrow key to quit.

If you restore the unit to the factory settings, all options such as battery level and delay, contrast, alarms, and other system choices are returned to their default values. However, no waypoints, routes, or icons are erased. (Waypoints and icons are turned off, however.)

## WAYPOINT NAVIGATION

One of the GlobalMap Sport's™ features is the ability to save locations in memory. These locations are called "waypoints". They're useful for marking shipwrecks, hot fishing or hunting spots, hiking trails, and other locations. Storing waypoints in the GlobalMap Sport's™ memory makes it easy to return to any point in the world by simply pressing a few buttons.

The GlobalMap Sport™ can store up to 250 waypoints. You can store your present position, the cursor's location, or enter latitude/longitude positions as waypoint locations.

### Saving Your Present Position as a Waypoint (Quick Save Method)

To save your present position, simply press the WPT key twice. The GlobalMap Sport™ puts your position into the first available waypoint number. A message appears on the display telling you the waypoint number it just used. This also places you in the waypoint menu as shown below. Anytime this menu is showing, simply press the WPT key and the unit will store your present position in the waypoint list. Wait a few seconds and the menu will clear automatically, or press the EXIT key to erase the waypoint menu.

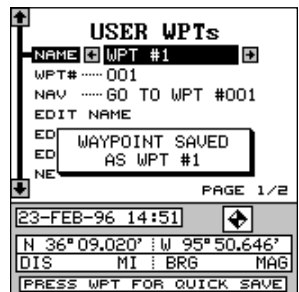

### Saving The Cursor Position as a Waypoint

When the cursor is showing on the map and you press the WPT key twice, the GlobalMap Sport™ puts the *cursor's* position into the first available waypoint number. A message appears on the display telling you the waypoint number it just used. This also places you in the waypoint menu as shown below. Wait a few seconds and the menu will clear automatically or press the EXIT key to erase the waypoint menu.

### Saving Your Present Position as a Waypoint (Select Number Method)

The method shown above doesn't let you choose the waypoint number. You can pick the waypoint number, then save your present position. To do this, first press the WPT key once. A screen similar to the one at right appears.

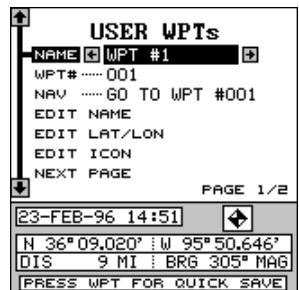

Now press the down arrow key once. This is the waypoint number selection menu. Press the left or right arrow keys until the waypoint number appears that you wish to store your present position.

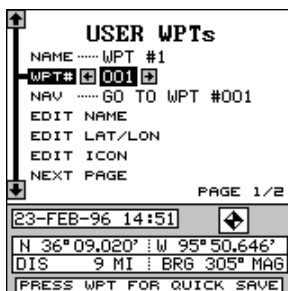

Now press the down arrow key until the black box is on the "NEXT PAGE" label. Press the right arrow key. The screen shown at right appears. This is the second waypoint menu page.

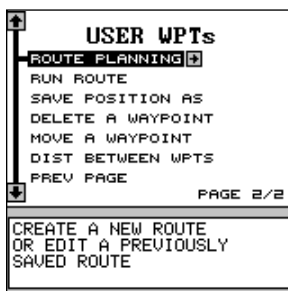

Press the down arrow key until the black box is on the "Save Position As" label. When you're at the location you wish to save, press the right arrow key. This saves your present position under the waypoint number you selected on the first page.

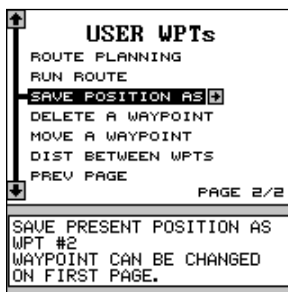

### **Saving Cursor Position as a Waypoint (Select Number Method)**

To save the cursor position under a specific waypoint number, first position the cursor at the desired position. Then follow the above instructions for saving your present position as a waypoint using the select number method. Remember, the method of saving your present position and the cursor's position is identical.

## Edit Lat/Lon

The GlobalMap Sport™ lets you enter any latitude/longitude using the keyboard and save it under any waypoint number, from 1 to 250. You can also change any waypoint's position using this method. To do this, first select the waypoint number. When you press the WPT key, the GlobalMap Sport™ places you at the last-used waypoint number. If you want to save the location under a different waypoint number, press the down arrow key until the black box is on the "WPT #" label. Now press the left or right arrow keys until the desired waypoint number appears. In this example, we moved it to waypoint number three.

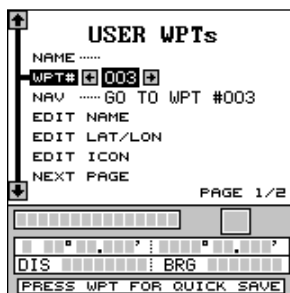

When the desired waypoint number is showing, press the down arrow key to move the black box to the "EDIT LAT/LON" label, then press the right arrow key. The screen shown at right appears. To enter the latitude, simply move the black box using the right and left arrow keys, then press the up or down arrow keys until the desired number appears. If you make a mistake, simply move the black box back to the number you need to change, and change it. If you want to change the entire latitude number, press the WPT key to erase it and start over. To exit completely out of this screen without saving the position, press the EXIT key.

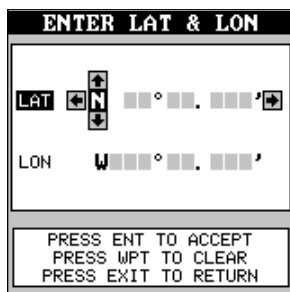

When the latitude is the way you want it, press the right arrow key to move the black box to the longitude. Now enter the longitude.

When you're ready to save this position and return to the waypoint screen, press the ENT key. The location you entered shows at the bottom of the screen under the waypoint number you selected.

## WAYPOINT NAMES

The GlobalMap Sport™ lets you assign a name to each waypoint. The name can have up to twelve characters. To name a waypoint, first select the waypoint number that you wish to name. (Note: A waypoint must have a position stored before you can name it.) Now move the black box to the "EDIT NAME" label and press the right arrow key. A screen similar to the one at the top of the next page appears.

Press the up or down arrow keys to select the first letter in the name. Press the right arrow key to move the black box to the next position in the name. Repeat this sequence until you've entered all of the letters in the waypoint name. Press the ENT key to accept this name, the WPT key to erase all characters in the name, or the EXIT key to leave this screen without saving any changes.

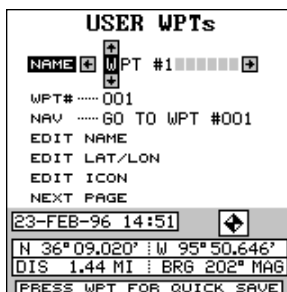

Tip: You can select waypoints by name instead of by number. Simply press the right arrow key while the black box is on the "Name" portion of the waypoint menu, then press the up or down arrow keys until the desired waypoint name appears.

## WAYPOINT ICONS

When you save a waypoint, the GlobalMap Sport™ automatically assigns an icon to it. If you wish to change it to a different icon, first press the down arrow key until the black box is on the "EDIT ICON" label. Now press the right arrow key. The screen shown at right appears.

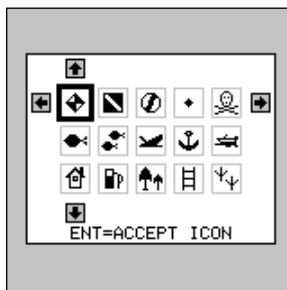

Press the arrow keys to move the black box to the desired icon, then press the ENT key to assign it to your waypoint. The unit returns to the waypoint screen.

## Delete a Waypoint

To remove all information from a waypoint, first select the waypoint number on the waypoint menu's first page that you wish to delete. Next, press the down arrow key until the black box is on the "Next Page" label. Press the right arrow key. Now press the down arrow key until the black box is on the "Delete A Waypoint" label. Press the right arrow key. A message appears, asking you if you really want to delete the selected waypoint. If you choose yes, all information in the selected waypoint will be deleted. The unit returns to the second waypoint menu page. You can make other waypoint selections or press the EXIT to erase this menu.

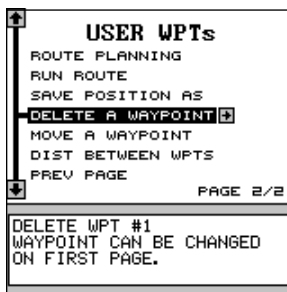

## Move a Waypoint

You can move all information from one waypoint number to another. In this example, we'll move all of the information in waypoint number one to waypoint number 10. To do this, go to the second waypoint menu page. Now press the down arrow key until the black box surrounds the "Move A Waypoint" label. Press the right arrow key. The screen shown at right appears.

| MOVE WAYPOINT           |               |
|-------------------------|---------------|
| SELECT                  | FROM TO       |
| NAME                    | WPT #1        |
| WPT#                    | 001           |
| ➔                       |               |
| FROM                    | TO            |
| WPT #1                  | WPT #1        |
| WPT #1                  | WPT #1        |
| N 36° 09.020'           | N 36° 09.020' |
| W 95° 50.646'           | W 95° 50.646' |
| [PRESS WPT TO MOVE WPT] |               |

The black box is resting on the "Select From" label. Now press the down arrow key to move the black box to either the name or waypoint number labels. You can select a waypoint to be moved by name or number. In this example, it's already on waypoint number one.

Once you have the desired waypoint showing on the screen that you're going to be moving the information FROM, then you need to choose the waypoint number that you're going to move that information TO. Move the black box back to the "Select" label at the top of the screen, then press the right arrow key to select "TO". Now choose the waypoint number that you wish to move the information to.

| MOVE WAYPOINT           |         |
|-------------------------|---------|
| SELECT                  | FROM TO |
| NAME                    | WPT #1  |
| WPT#                    | 010     |
| ➔                       |         |
| FROM                    | TO      |
| WPT #1                  | WPT #10 |
| WPT #1                  |         |
| N 36° 09.020'           |         |
| W 95° 50.646'           |         |
| [PRESS WPT TO MOVE WPT] |         |

When you have everything on this screen displayed correctly, press the WPT key. In this example, the name, icon, and position were moved from waypoint number 1 to waypoint number 10. Press the EXIT key to erase this screen when you're finished.

| MOVE WAYPOINT           |               |
|-------------------------|---------------|
| SELECT                  | FROM TO       |
| NAME                    | WPT #1        |
| WPT#                    | 010           |
| ➔                       |               |
| FROM                    | TO            |
|                         | WPT #1        |
|                         | WPT #10       |
|                         | N 36° 09.020' |
|                         | W 95° 50.646' |
| [PRESS WPT TO MOVE WPT] |               |

## Distance Between Waypoints

The GlobalMap Sport™ can easily give you the distance between two waypoints. To do this, first press the WPT key, then move the black box to the "Next Page" label and press the right arrow key. Now move the black box to the "Dist Between WPTS" label and press the right arrow key. A screen similar to the one at the top of the next page appears.

The black box is resting on the "Select WPT A" label. Now press the down arrow key to move the black box to either the name or waypoint number labels. You can select a waypoint by name or number. In this example, we used the number method and we're going to measure the distance between waypoint numbers three and four.

| DIST BETWEEN WPTS         |               |
|---------------------------|---------------|
| SELECT <b>WPT A</b> WPT B |               |
| NAME                      | ..... WPT #1  |
| WPT#                      | ..... 001     |
| <b>WPT A</b>              | <b>WPT B</b>  |
| WPT #1                    | WPT #1        |
| WPT #1                    | WPT #1        |
| N 36° 09.020'             | N 36° 09.020' |
| W 95° 50.646'             | W 95° 50.646' |
| DIST FROM A TO B: 0.00MI  |               |
| BRG FROM A TO B: 359° MAG |               |

Once you have the first waypoint showing on the screen, then you need to choose the other waypoint that you're going to measure. Move the black box back to the "Select" label at the top of the screen, then press the right arrow key to select "B". Now choose the waypoint that you wish measure. The distance and bearing from the first waypoint "A" to the second waypoint "B" shows at the bottom of the screen. You can select more waypoints to measure at this time or press the EXIT key to erase this screen.

| DIST BETWEEN WPTS              |               |
|--------------------------------|---------------|
| SELECT..... <b>WPT A</b> WPT B |               |
| NAME                           | ..... WPT #4  |
| WPT#                           | ..... 004     |
| <b>WPT A</b>                   | <b>WPT B</b>  |
| WPT #3                         | WPT #4        |
| WPT #3                         | WPT #4        |
| N 36° 09.032'                  | N 36° 10.010' |
| W 95° 50.640'                  | W 95° 50.126' |
| DIST FROM A TO B: 1.22MI       |               |
| BRG FROM A TO B: 22° MAG       |               |

### Navigate To a Waypoint

Once you have waypoints stored in the GlobalMap Sport's™ memory, you'll want to recall and navigate to them. To do this, press the WPT key, then move the black box to the "NAME" or "WPT#" label. Now press the right or left arrow keys to select the desired waypoint. In this example, we're navigating to waypoint number 40. Once you've selected the waypoint, move the black box to the "NAV" label and press the right arrow key. This starts the GlobalMap Sport's™ navigation system. It will show navigation data to the selected waypoint on all navigation and mapping screens.

| USER WPTS                   |                       |
|-----------------------------|-----------------------|
| NAME                        | ..... WPT #40         |
| WPT#                        | ..... 040             |
| NAV                         | <b>GO TO WPT #040</b> |
| EDIT NAME                   |                       |
| EDIT LAT/LON                |                       |
| EDIT ICON                   |                       |
| NEXT PAGE                   |                       |
| PAGE 1/2                    |                       |
| 26-FEB-96 02:14             |                       |
| N 36° 17.603' W 95° 46.127' |                       |
| DIS 8.41 MI BRG 202° MAG    |                       |
| (PRESS WPT FOR QUICK SAVE)  |                       |

### Navigating to a Waypoint using the Map

The unique "birds-eye" view used by the mapping screen gives you an easy way to navigate to a waypoint. On the map screen shown below, the diamond with a cross in it is your present position. The box with the "S" in it was your starting location when you recalled the



waypoint. The dotted line is called a track line and is the shortest path to the waypoint. The “D” is the destination, the recalled waypoint’s location. If you follow the track line, you’ll reach the waypoint, covering the shortest distance in the least time.

**(CAUTION!)**

The GlobalMap Sport™ does NOT take land features into account when it projects the track line on the screen. Therefore, you must use care when navigating on the track line and avoid collisions with any object that may be in your path to the waypoint.

**Navigating to a waypoint using the steering screen**

One of the windows is a steering screen that shows your position relative to the desired track line. It’s used in the bottom half of group “O” as shown below. Your present position and direction is represented by the arrow in the center of the window. As long as the arrow is pointing towards the top center of the window, you’ll be on course for the recalled waypoint. Numbers on the left side of the window show the remaining distance to the waypoint.



Numbers at the bottom of the window show the cross track error range. This is the distance to the right or left of the desired track line. In the example shown below, the arrow is on the right dotted vertical line, and the cross track error is .05 mile or you’re .05 mile to the right of the optimum track line. You’ll need to steer to the left to get back on the correct line.

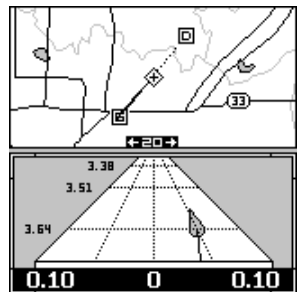

The cross track range is adjustable by changing the cross track alarm. For example, if the cross track alarm is .10 miles, then the range shown on the steering screen is .10 mile to the left and right of the track line. If you exceed .10 mile, the alarm will sound.

See the alarms section for information on changing the alarm settings.



## WAYPOINT OPTIONS

You can customize the way a waypoint shows on the GlobalMap Sport's™ mapping screens. To do this, first press the MENU key, then press the up or down arrow keys until the black box is on the Waypoint Options label, then press the right arrow key. The screen shown at right appears.

You can turn all of the waypoints on or off (Waypoints), an icon (Waypoint Symbols), its name (Waypoint Names), or its number (Waypoint Numbers). Press the up or down arrow keys to move the black box to the desired menu, then press the right arrow key to turn it on. Press the EXIT key to erase this menu.

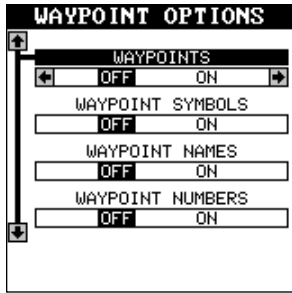

## ROUTES

You can connect several waypoints together to form a route. When you recall the route, the GlobalMap Sport™ will show you navigation information to the first waypoint in the route, then when you reach that waypoint, it switches to the next waypoint, and so on until you reach the last waypoint in the route.

To create a route, first press the WPT key, then move the black box to the "Next Page" label and press the right arrow key. Now move the black box to the "Route Planning" label and press the right arrow key. The screen shown at right appears.



This unit can store up to twenty different routes. Route number one shows at the top of this page. If you wish to create a route using a different number, simply press the left or right arrow keys until the desired route number appears. In this example, however, we'll use route number one.

Beneath the route number is the route name menu. If you wish to name the route, move the black box to the "NAME" field, then press the right arrow key. Use the arrow keys to name the route, then press the ENT key when you're finished.

Now move the black box to the top of the stack of gray boxes at the bottom of this screen as shown at right. This is the list of waypoints used in your route. To select the first waypoint in the route, press the right arrow key. A new menu appears as shown below.



You can place a waypoint using the waypoint list or from locations on the map, or both. For the first waypoint, we'll use the "Insert From WPTS" method. With the black box on this menu, press the right arrow key. A screen similar to the one below appears.



**Select Waypoints - Waypoint list**

Select the first waypoint either by using the waypoint name or waypoint number menus. As you move through the list of saved waypoints, their date and time saved, icon, position, distance and bearing from your present position show at the bottom of the screen. When the desired waypoint appears that you want to use as the first waypoint on the route, move the black box to the "Add WPT To Route" label, then press the right arrow key. The unit returns to the route planning screen with this waypoint at the top of the stack.

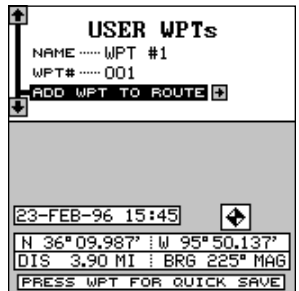

## Select Waypoints - From Map

To add a position from the map to the route's list of waypoints, first move the black box to the position on the list of waypoints that you want to add the position. In this example, we simply moved the black box to the second position on the map. Next, press the right arrow key. Now move the black box to the "Insert From Map" label and press the right arrow key. The unit returns to the mapping screen with the cursor on. (See below.)

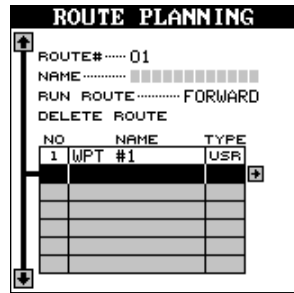

Move the cursor (using the arrow keys) until it's on the exact location that you want to add to the route list. When it's there, press the ENT key.

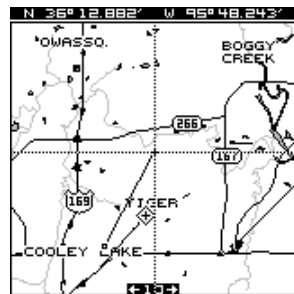

As you move the cursor, a line moves with it. This line shows you the path from the last waypoint on the list. You can continue to save waypoints on the map by moving the cursor and pressing the ENT key to save the location. When you're done, a line connects all the waypoints on the route, graphically showing you a diagram of your route. When you're finished saving locations, press the EXIT key. The unit returns to the route planning menu.

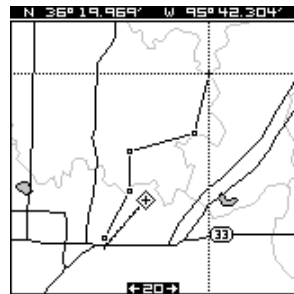

The locations you saved for your route from the map have not only been added to the route list, but have also been added to the waypoint list.

## Finishing the Route

When you've selected all of the waypoints for the route, simply press the EXIT key. Your route is saved in memory.



## Following a Route

To recall a route, press the WPT key, then move the black box to the “Next Page” label at the bottom of the screen and press the right arrow key. Now move the black box to the “Run Route” label and press the right arrow key. The screen shown below appears.

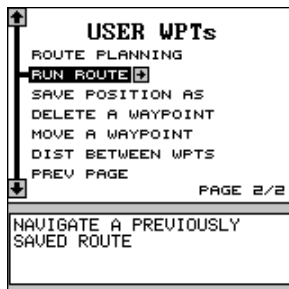

The black box is on the “Route # 01” label. If this isn’t the route you want to use, press the right or left arrow keys to switch to another one. Before starting the route, you’ll need to decide if you want to start at the beginning and travel forward or start at the last waypoint in the route and travel backwards (reverse) to the first waypoint. The default is forward.



You can also start at any waypoint in the route by moving the black box to the “Start at NO 01” label, then pressing the left or right arrow keys to change the starting waypoint number. As you change the number, the “START” label moves down the list of waypoints in the lower half of the screen.

When you have everything on this screen set as desired, press the ENT key to start the GlobalMap Sport™ navigating to the first waypoint on the route.

As you travel to the first waypoint, the unit shows navigation data to the waypoint. When the arrival alarm sounds, the GlobalMap Sport™ automatically switches to the next waypoint on the list, showing navigation data to that waypoint, and so on until the last waypoint on the route list has been reached.

## Waypoint Detail

To view the position, bearing, distance, and other information about a waypoint saved in a route, first select the route, then move the black box to the desired waypoint. Now press the right arrow key. The screen shown at right appears.



Move the black box to the "Detail" label and press the right arrow key. The screen shown at right appears. When you're finished viewing this information, press the EXIT key to erase it.

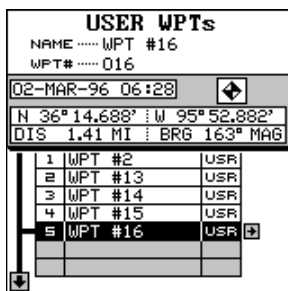

## Delete a Route

To erase a route from the GlobalMap Sport's™ memory, first press the WPT key, then go to the Route Planning menu on the second waypoint page. Switch to the route number you wish to erase, then move the black box to the "Delete Route" label. Press the right arrow key to delete it.

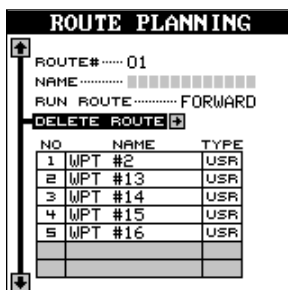

## NAVIGATE TO CURSOR POSITION

You can navigate to a position without saving it as a waypoint by using the cursor on any map screen. To do this, first switch to a map screen. In these examples, we're using map number 1. Next, press an arrow key to activate the cursor. Now move the cursor to the desired location on the map that you want to navigate to. Now press the MENU key, then move the black box to the "Go To Cursor" label. Press the right arrow key. A message appears on the screen. When it disappears, you'll see that the GlobalMap Sport™ is navigating to the cursor position. Press the EXIT key to erase the cursor.

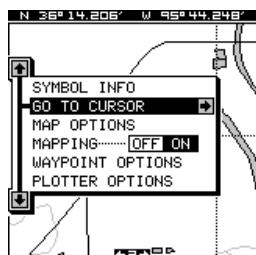

## CANCEL NAVIGATION

The GlobalMap Sport™ continues to navigate to a recalled waypoint, the last waypoint in a route, or the cursor position until you stop it.

To stop the navigation function, press the MENU key, then press the up or down arrow keys until the black box is on the “Cancel Navigation” label. Press the right arrow key. The unit stops showing navigation information.

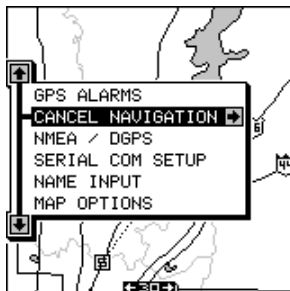

## BATTERIES

When using the GlobalMap Sport™ with batteries, remember that the backlights automatically turn off after 30 seconds. (Remember, you can change the time interval.) Pressing the PWR key turns the lights on again.

If the batteries become weak, the message shown at right appears on the display. When the battery voltage drops below a certain level, the unit automatically turns itself off. A message shows on the screen about a minute before it shuts down.

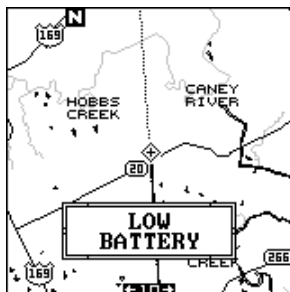

When switching from external power to the batteries, a tone sounds which alerts you to the fact that you're now on battery power.

Store your unit with the battery pack attached. Do not remove the batteries. This will increase the internal memory's battery life.

## MAP 4 STEERING INDICATOR

The box at the bottom of Map 4 is a steering indicator. It's used when navigating to a waypoint or cursor position. The arrow in this box shows the direction you should steer to get back on course. If the arrow points straight up, then you are on course to the waypoint or cursor location. If it points left, then you should head to the left to get back on course.

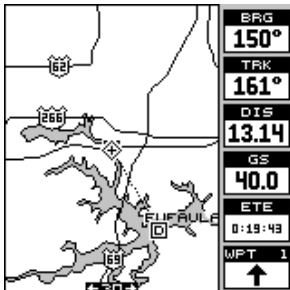

## DEFINITION OF TERMS/ABBREVIATIONS

Due to space considerations, the digital displays use abbreviations for some names. They are as follows:

- ALT ..... Altitude - Your height above sea level.
- BRG ..... Bearing - The direction from your present position to a waypoint.
- CLOCK ..... Your local time.
- TRK ..... Track - The direction you're travelling.
- DIS ..... Distance - Distance remaining between your present position and a waypoint.
- DNT/UPT ..... Countdown timer (DNT) and Count up timer (UPT)
- ETE ..... Estimated Time En route
- ICON ..... A symbol you can place on the map, representing a landmark.
- POSITION .... Your present position.
- GS ..... Ground Speed - Your actual speed.
- TTG ..... Time To Go - Time remaining at your present speed until you reach a waypoint.
- VMG ..... Velocity Made Good - Actual speed towards a waypoint.
- XTE ..... Cross Track Error - Distance to the **side** of the desired course line.

## GPS - HOW IT WORKS

The Global Positioning System (GPS) is the latest in high-tech navigation systems. Conceived by the United States military, the GPS system is an answer to their need of a highly accurate, 24-hour, 365 day a year global positioning system.

Basically, the system works by using a constellation of satellites orbiting Earth 11,000 miles in space. As of this writing, there are 25 satellites in orbit. Before satellites reach the end of their life, new ones are launched. This keeps at least four satellites in view virtually anywhere on Earth 24-hours a day. The GPS receiver requires at least three satellites to give a "2D" fix. (A 2D fix is your position in latitude/longitude. A 3D fix is your latitude/longitude plus altitude.) When the receiver locks onto at least four satellites, it displays a 3D fix.

As the receiver locks on to each satellite, it calculates the distance from the satellite by measuring the length of time it takes the radio signal to reach it. Each satellite has an extremely accurate clock that tells the receiver when the radio transmission started. The receiver compares that

time against its own clock, thus it knows how long it took the signal to reach it. Since the receiver knows the time and the speed of the signal, the distance to the satellite can be easily calculated. Once it has the distance to three satellites, the receiver calculates and displays your position.

## **ACCURACY**

You may have heard tales of extraordinary accuracy from GPS receivers. The DOD (Department of Defense) requires an accuracy of 15 meters or less from the satellite system. However, only the military gets this precision. Civilian GPS receivers accuracy is considerably less than the military's. There are two methods used to degrade the system's accuracy to civilian users. The data transmitted from the satellites is encrypted using two different codes: P-code and C/A code. The military receivers use the P-code, while civilians use the C/A code. The P-code is the more accurate one. Theoretically, C/A code can give accurate position fixes of up to 15 meters.

However, (as of this writing) the military isn't satisfied with C/A's potential accuracy in the hands of the world. So, it uses Selective Availability (S/A) to degrade the accuracy further. S/A is small, random errors intentionally added to the system so your accuracy will typically be within 100 meters of your true position. Of course, accuracy also depends on the angle of the satellite above the horizon, signal-to-noise ratio, the number of satellites tracked at one time (the more the better), and other factors.

Due in part to the effects of S/A, you will see your position on the mapping display move even if you're sitting still.

For more accurate positioning, DGPS (Differential GPS) is installed in some parts of the country. DGPS transmitters broadcast a correction signal that not only eliminates the S/A effects, but gives extremely accurate positions. This system requires a DGPS beacon receiver that decodes the signal from the DGPS transmitter and sends it to a DGPS capable unit such as the GlobalMap Sport™.



## **LOWRANCE ELECTRONICS FULL ONE-YEAR WARRANTY**

"We", "our", or "us" refers to LOWRANCE ELECTRONICS, INC., the manufacturer of this product. "You" or "your" refers to the first person who purchases this product as a consumer item for personal, family, or household use.

We warrant this product against defects or malfunctions in materials and workmanship, and against failure to conform to this product's written specifications, all for one year (1) from the date of original purchase by you. WE MAKE NO OTHER EXPRESS WARRANTY OR REPRESENTATION OF ANY KIND WHATSOEVER CONCERNING THIS PRODUCT. Your remedies under this warranty will be available so long as you can show in a reasonable manner that any defect or malfunction in materials or workmanship, or any non-conformity with the product's written specifications, occurred within one year from the date of your original purchase, which must be substantiated by a dated sales receipt or sales slip. Any such defect, malfunction, or non-conformity which occurs within one year from your original purchase date will either be repaired without charge or be replaced with a new product identical or reasonably equivalent to this product, at our option, within a reasonable time after our receipt of the product. If such defect, malfunction, or non-conformity remains after a reasonable number of attempts to repair by us, you may elect to obtain without charge a replacement of the product or a refund for the product. THIS REPAIR, REPLACEMENT, OR REFUND (AS JUST DESCRIBED) IS THE EXCLUSIVE REMEDY AVAILABLE TO YOU AGAINST US FOR ANY DEFECT, MALFUNCTION, OR NON-CONFORMITY CONCERNING THE PRODUCT OR FOR ANY LOSS OR DAMAGE RESULTING FROM ANY OTHER CAUSE WHATSOEVER. WE WILL NOT UNDER ANY CIRCUMSTANCES BE LIABLE TO ANYONE FOR ANY SPECIAL, CONSEQUENTIAL, INCIDENTAL, OR OTHER INDIRECT DAMAGE OF ANY KIND.

Some states do not allow the exclusion or limitation of incidental or consequential damages, so the above limitations or exclusions may not apply to you.

This warranty does NOT apply in the following circumstances: (1) when the product has been serviced or repaired by anyone other than us, (2) when the product has been connected, installed, combined, altered, adjusted, or handled in a manner other than according to the instructions furnished with the product, (3) when any serial number has been effaced, altered, or removed, or (4) when any defect, problem, loss, or damage has resulted from any accident, misuse, negligence, or carelessness, or from any failure to provide reasonable and necessary maintenance in accordance with the instructions of the owner's manual for the product.

We reserve the right to make changes or improvements in our products from time to time without incurring the obligation to install such improvements or changes on equipment or items previously manufactured.

This warranty gives you specific legal rights and you may also have other rights which may vary from state to state.

REMINDER: You must retain the sales slip or sales receipt proving the date of your original purchase in case warranty service is ever required.

**LOWRANCE ELECTRONICS**  
12000 E. SKELLY DRIVE TULSA, OK 74128  
(800) 324-1356

## Lowrance's UPS Return Service - U.S.A. Only

Lowrance Electronics and United Parcel Service (UPS) are proud to offer all of our customers free shipping for all units sent to us for repair or service. If you have to send this unit to the factory, and you are in the continental United States, use the enclosed UPS shipping label for easy, free shipping to our factory customer service department. There are six easy steps:

1. Call Lowrance at the toll-free number on the front of this flyer for a Return Authorization (RA) number and instructions about what accessories to return. **Do not return a product to the factory without a Return Authorization (RA) Number!**
2. Pack your unit and any accessories in the original shipping container, if possible. **Be sure to include proof of purchase for warranty verification!**
3. Write a brief note detailing the problem you're having with the unit. Please include your name, address, and daytime telephone number.
4. Please include payment for non-warranty repairs. Check, money order, Visa, or MasterCard may be used.
5. Fill in your name, address, zip code, date, and RA number in the blanks provided on the UPS form included with your unit.
6. Attach the label to the shipping box, tear off the tab for your receipt and give the package to any UPS driver or take the package to any UPS Customer Center. You will not be charged for this shipment.

That's it! Your unit will be shipped to Lowrance's customer service department at no charge to you. Our normal in-plant turnaround on repairs is 3 working days. Units under warranty will be returned to you at no charge.

### NOTE!

Lowrance will pay UPS surface shipping charges both to and from the factory for this unit in the event it needs repair. Your unit is insured against loss or shipping damage when you use the enclosed UPS label.

This UPS shipping offer is good only in the continental United States (excludes Alaska and Hawaii).

**KEEP THIS LABEL!  
YOU WILL NEED IT IF YOU EVER NEED TO RETURN YOUR UNIT TO  
THE FACTORY FOR REPAIR.**

### **Accessory Ordering Information**

To order accessories such as power cables or transducers, please contact:

1) Your local marine dealer. Most quality dealers that handle marine electronic equipment should be able to assist you with these items. Consult your local telephone directory for listings.

2) LEI Extras, Inc. P.O. Box 129 Catoosa, OK 74015-0129  
or call  
800-324-0045  
(USA orders only.)

Lowrance Electronics may find it necessary to change or end our shipping policies, regulations, and special offers at any time. We reserve the right to do so without notice.

## **How to Obtain Service (Canadian Customers Only)**

We back your investment in quality products with quick, expert service and genuine Lowrance replacement parts. If you need service or repairs, contact the Lowrance Factory Customer Service Department at the toll-free number listed below. A technician may be able to solve the problem and save you the inconvenience of returning your unit. You will be asked for your unit's serial number.

**800-324-1356**

Canada Only, Monday through Friday 8:00 A.M. - 8:00 P.M. Central Time.

When sending a product for repair, please do the following:

1. Always use the original shipping container and filler material the product was packed in when shipping your product.
2. Always insure the parcel against damage or loss during shipment. Lowrance does not assume responsibility for goods lost or damaged in transit.
3. For proper testing, repair, and service, send a brief note with the product describing the problem. Be sure to include your name, return shipping address, and a daytime telephone number.

## **How to Obtain Service (International Customers Only - Except Canada)**

If you need service or repairs, contact the dealer in the country you purchased your unit.

**WARRANTY REPAIR WILL BE HONORED ONLY IN THE  
COUNTRY UNIT WAS PURCHASED.**

Please follow the shipping instructions shown below on this page if you have to mail your unit to the dealer. For proper testing, repair, and service, send a brief note with the product describing the problem. Be sure to include your name, return shipping address, and a daytime telephone number.

## **Accessory Ordering Information - All Countries**

To order accessories such as power cables or transducers, please contact:

1. Your local marine dealer. Most quality dealers that handle marine electronic equipment should be able to assist you with these items. Consult your local telephone directory for listings.
2. Canadian customers only can write:  
Lowrance/Eagle Canada, 919 Matheson Blvd., E. Mississauga, Ontario L4W2R7  
or fax 416-629-3118



Your unit's serial number

## **How to Obtain Service - U.S.A. Only**

We back your investment in quality products with quick, expert service and genuine Lowrance® replacement parts. If you're in the United States and you have questions, please contact the Factory Customer Service Department using our toll-free number listed below. You must send the unit to the factory for warranty service or repair. Please call the factory before sending the unit. You will be asked for your unit's serial number (shown above). Use the following toll-free number:

**800-324-1356**

U.S.A. only. Monday through Friday 8:00 A.M. - 8:00 P.M. Central time, except holidays.

Your unit is covered by a full one-year warranty. (See the back of this flyer for complete warranty details.) If your unit fails and the failure is not covered by the original warranty, Lowrance has a flat-rate repair policy that covers your unit and accessories packed with the unit at the factory. There is a 180-day warranty on all non-warranty repairs from the factory, which is similar to the original warranty, but is for 180 days rather than one year. For further details, please call us at the above number.

On factory repairs, we guarantee your unit will be repaired in three working days from the time it is received. This does not include shipping time. If for some reason we cannot meet this commitment, we will extend your warranty for another full year, free of charge, from the date of repair.

Lowrance also gives you free UPS shipping from anywhere in the continental United States both to and from the factory for all warranty repairs. You can also use the enclosed UPS shipping label for non-warranty shipments. See the inside of this flyer for more information. Remember, non-warranty repairs are subject to Lowrance's published flat-rate charges and 180-day warranty. A 3 working day turnaround time at the factory repair center is guaranteed. (Does not include shipping time.)