



AirMap[®] 100

**INSTALLATION AND
OPERATION INSTRUCTIONS**



Copyright © 1996, 1997, 1998 Lowrance Electronics, Inc.
All rights reserved.

AirMap™ 100 is a trademark of Lowrance Avionics.
Lowrance® is a registered trademark of Lowrance Electronics, Inc.
Jeppesen® is a registered trademark of Jeppesen Sanderson, Inc.

WARNING!

USE THIS UNIT ONLY AS AN AID TO NAVIGATION. A CAREFUL NAVIGATOR NEVER RELIES ON ONLY ONE METHOD TO OBTAIN POSITION INFORMATION.

Never use this product while operating a vehicle.

The background map built into this unit is not intended for navigation and its accuracy has not been verified. This map is derived from U.S. government sources which rely on ground and aerial surveys and satellite data. Since there can be inaccuracies in the data used to create the maps and in the map's resolution, plus position inaccuracies in the navigation system, use caution when using this product.

CAUTION

When showing navigation data to a position (waypoint), this unit will show the shortest, most direct path to the waypoint. It provides navigation data to the waypoint regardless of obstructions. Therefore, the prudent navigator will not only take advantage of all available navigation tools when travelling to a waypoint, but will also visually check to make certain a clear, safe path to the waypoint is always available.

The operating and storage temperature for your unit is from -4 degrees to +167 degrees Fahrenheit (-20 to +75 degrees Celsius). Extended storage temperatures higher or lower than specified will cause the liquid crystal display to fail. Neither this type of failure nor its consequences are covered by the warranty. For more information, consult the factory customer service department.

All features and specifications subject to change without notice.

Lowrance Avionics may find it necessary to change or end our policies, regulations, and special offers at any time. We reserve the right to do so without notice.

All screens in this manual are simulated.

This device complies with Part 15 of the FCC Rules. Operation is subject to the following two conditions: (1) this device may not cause harmful interference, and (2) this device must accept any interference received, including interference that may cause undesired operation.

Note:

This equipment has been tested and found to comply with the limits for a Class B digital device, pursuant to Part 15 of the FCC Rules. These limits are designed to provide reasonable protection against harmful interference in a residential installation. This equipment generates, uses and can radiate radio frequency energy and, if not installed and used in accordance with the instructions, may cause harmful interference to radio communications. However, there is no guarantee that interference will not occur in a particular installation. If this equipment does cause harmful interference to radio or television reception, which can be determined by turning the equipment off and on, the user is encouraged to try to correct the interference by one or more of the following measures:

- Reorient or relocate the receiving antenna.
- Increase the separation between the equipment and receiver.
- Connect the equipment into an outlet on a circuit different from that to which the receiver is connected.
- Consult the factory customer service department for help.

Specifications

Dimensions	6.75" L x 2.25" W x 1.625" D
Display	160 H x 104 W pixels
Power	5-35 vdc
Waypoints	750
Routes	99
Waypoints per Route (maximum).....	99
Total Waypoints used in Routes	1500
Icons	1000
Savable Plot Trails	3
Maximum Plot Trail Points	3000 per trail

DEFINITION OF TERMS/ABBREVIATIONS

Due to space considerations, the digital displays use abbreviations for some names. They are as follows:

- ALT Altitude
- BRG Bearing - The direction from your present position to a waypoint.
- CDI Course Deviation Indicator - Shows your distance to the side of the desired course line.
- CLOCK Your local time.
- TRK Track - The direction you're travelling.
- DIS Distance - Distance remaining between your present position and a waypoint.
- DNT/UPT Countdown timer (DNT) and Count up timer (UPT)
- ETA Estimated Time of Arrival
- ETE Estimated Time En route
- ICON A symbol you can place on the map, representing a landmark.
- POSITION Your present position.
- GS Ground Speed - Your actual speed.
- UTC Coordinated Universal Time - Time at the prime meridian at Greenwich, England. Formerly known as GMT.
- VOLTS Electrical system voltage.
- VMG Velocity Made Good - Your ground speed towards a recalled waypoint, airport, etc.

INTRODUCTION	1
SA - What is it?	2
Don't Get Lost	2
GETTING STARTED	3
Power	3
BATTERIES	3
Battery Installation	3
NiMH Battery	3
External Antenna	4
Yoke Mount	5
OPERATION	6
Turning Power On	6
Satellite Status Screen	6
Finding Your Position	8
Auto Search	8
Manual Initialization	8
Position Acquisition	9
POSITION/NAVIGATION SCREENS	9
Navigation Screens	10
Course Deviation Indicator (CDI)	11
Map	12
Cursor	14
Map Symbols	14
Obstructions	15
Airspace	16
Map Setup	18
Map Options	18
Map Orientation	18
Autozoom	20
View Destination	21
Range Rings/Grid Lines	21
Earth Map Options	22
Earth Map On/Off	22
Text Labels	22
Locations	22
Map Detail	22
Gray Fill	23
Map Boundaries	24
Air Map Options	24
Runway Extensions	25
Plot Trail Options	26
Clear Trail	26
Flash Trail	26
Update Options	26
Save Trail	26
Show Trail	27
ICONS	27
MAP DOWNLOADING	29
WINDOWS	31
Reprogram Window Groups	36
Reprogram Boxes	37
RESET GROUPS	38
DATABASES	38
Aviation Database	38
User Database - Waypoints	42

WAYPOINTS	42
Waypoint Menu	42
Saving Your Present Position as a Waypoint (Quick Save Method)	42
Saving The Cursor Position as a Waypoint	43
Saving Your Present Position as a Waypoint (Select Number Method)	43
Saving a New Position	44
Waypoint Averaging	44
Project a Waypoint	45
Selecting a Waypoint	46
Editing a Waypoint	46
NAVIGATION	47
Navigating to a cursor location	47
Navigating to a Waypoint using the Map	48
OTHER WAYPOINT OPTIONS	49
Move a Waypoint	49
Delete a Waypoint	49
Delete All Waypoints	49
"Nearest" Feature	50
ROUTES	51
Create a Route	51
Delete a Waypoint from Route	53
Waypoint Statistics	53
Following a Route	53
Waypoint Information	54
Delete a Route	55
CANCEL NAVIGATION	55
Navigation Notes	55
SYSTEM SETUP	56
Sound	56
Contrast	56
Set Local Time	57
Units of Measure	57
NMEA / DGPS	57
NMEA Output	58
DGPS	58
Serial Communication Setup	59
Reset Options	60
Reset Groups	61
System Info	61
GPS SETUP	61
Power Save	60
Position Format	60
DATUM	62
PCF (Position Correction Factor)	63
POSITION PINNING	64
ALARMS	65
SUNRISE/SET MOONRISE/SET CALCULATOR	67
SIMULATOR	67
E6B COMPUTER	68
AVIATION DATA DOWNLOAD	71
JEPPESEN® DATABASE UPGRADE	73
DATUM LIST	74
UPS RETURN SERVICE	79
WARRANTY	81
DATABASE LICENSE AGREEMENT	82
DATABASE WARRANTY	83

INTRODUCTION

Thank you for purchasing a Lowrance Avionics AirMap 100. With its large LCD screen, easy to use menus, and outstanding performance, we think you'll be happy with your AirMap 100 for many years. No other handheld GPS receiver on the market today has the AirMap's combination of 12 channel receiver, Jeppesen® database with obstacles (U.S. only), ground and hydrographic mapping capability, and programmable screens in a handheld unit.

The Global Positioning System (GPS) was developed by the United States Department of Defense as a 24-hour a day, 365 days a year global navigation system for the military. Civilian availability was added (but with less accuracy) using the same satellites. Twenty-four satellites orbit the Earth. Three of these satellites are spares, unused until needed. The rest virtually guarantee that at least four satellites are in view of anyplace on Earth at all times.

The system requires three satellites in order to determine a position. This is called a 2D fix. It takes four satellites to determine both position and elevation, (your height above sea level - also called altitude.) called a 3D fix.

Remember, the unit must have a clear view of the satellites in order to receiver their signals. Unlike radio or television, GPS works at very high frequencies. The signals can be blocked easily by trees, buildings, even your body. Fortunately, they do travel through glass and plastic, so your receiver will work in the aircraft, if it has a clear view of the satellites through the windshield or side windows. Let someone else drive if you use it in a car or other vehicle.

Never use this GPS receiver while operating a vehicle!

The first time you use this unit, walk outside and turn it on in your backyard, an open field or park. Once it locks onto the satellites, you can experiment with it around buildings and trees. This will give you some idea of its sensitivity to blockage.

Like most GPS receivers, this unit doesn't have a compass or any other navigation aid built inside. It relies solely on the signals from the satellites to calculate a position. Speed, direction of travel, and distance are all calculated from position information. Therefore, in order for it to determine direction of travel, you must be moving and the faster, the better. This is not to say that it won't work at walking speeds - it will. There will simply be more "wandering" of the data shown on the display.

SA - What is it?

Another factor that greatly influences the receiver's ability to determine position is SA. The United States government intentionally degrades the satellites signal for civilian users. They introduce small errors into the satellite's signals that makes the GPS receiver less accurate. These errors are called selective availability, or SA. How bad is it? They guarantee that the position reported by a GPS receiver that meets their specifications is within 100 meters horizontally and 150 meters vertically 95% of the time. (The position can be better than that or worse than that the other 5% of the time.) In other words, the position shown on your receiver is within 100 meters of your actual position, 95% of the time. That's over 300 feet! Not exactly pinpoint accuracy, but then few people need positioning accuracy greater than this. However, if you do want better performance, (and who doesn't?) many manufacturers (including Lowrance) sell a DGPS receiver that attaches to your GPS receiver. The DGPS system transmits correction signals that nullify the effects of SA. The DGPS receiver takes signals from these land-based transmitters and gives them to the GPS receiver which then uses them to show a more accurate position. The ironic part is the federal government implemented SA and is also operating many DGPS transmitters. (You can use the signals from all of the Coast Guard DGPS stations for free, by the way.) The downside to this is it requires another piece of electronic gear (the DGPS receiver) which usually isn't small enough to carry with you, but will work nicely on a vehicle. And you have to be close enough to a station to receive the DGPS signals.

Don't Get Lost

Generally, you find that using your GPS receiver without DGPS is both easy and amazingly accurate. It's easily the most accurate method of electronic navigation available to the general public today. Remember, however that this receiver is only a tool. Always have another method of navigation available, such as a chart or map and a compass. It's a good idea to carry spare batteries with you, especially if you're venturing into unknown territory.

Also remember that this unit will always show navigation information in the shortest line from your present position to a waypoint, regardless of terrain! It only calculates position, it can't know what's between you and your camp, for example. It's up to you to safely navigate around obstacles, no matter how you're using this product.

GETTING STARTED

Power

The AirMap 100 operates from AA batteries, a DURACELL® NiMH rechargeable battery, or from 5 to 35 volts DC using the external power cable. If the power cable is used, the AirMap 100 automatically switches to it if the external power is greater than the battery voltage. If for any reason the external power fails, the unit automatically switches to the batteries.

BATTERIES

The unit requires four AA batteries. We recommend you use alkaline batteries for the best trade-off between battery life and cost. However, you can use nickel-cadmium (ni-cad), or lithium batteries. You can also use rechargeable alkaline batteries such as RayOVac® Renewals®. With the exception of lithium, none of the above batteries will last as long as standard alkaline batteries. We recommend DURACELL® brand, but others will work. Do not use “heavy-duty” batteries or any type other than the ones listed above. Do not mix different types of batteries. (For example, don’t use both alkaline and ni-cad batteries at the same time.)

Battery Installation

First turn the unit so that its back is facing you. Push the two tabs to the left and remove the battery cover as shown at right. Install the batteries according to this diagram. (There’s a decal in the battery compartment showing the correct polarity, also.) Replace the battery compartment cover and the unit is ready for use.

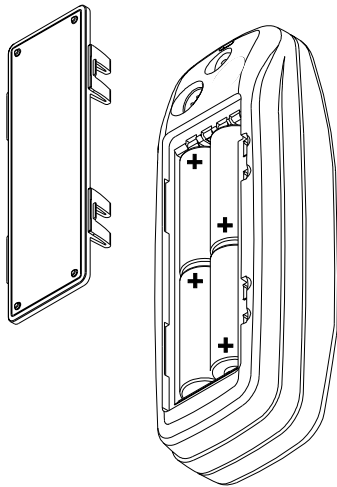

NiMH Battery

The DURACELL® DR-121 nickel-metal hydride (NiMH) battery replaces the four standard batteries. It is sold as an accessory, model BR-1 which includes a charger custom designed for the DR-121. The battery never needs to be removed from the unit, since the charger connects to the GPS receiver and charges the DR-121. You can even use the receiver while the battery is charging!

To install the NiMH battery, remove the battery cover and place the battery into the compartment as shown on the next page. It will only fit one way, so if it’s difficult to install, simply turn it over and drop it into place. Replace the compartment cover and follow the charging instructions included with the BR-1.

(Note: The DR-121 is the only battery that can be recharged in this unit! Using the external power cable alone does not charge the battery! You must use a charger supplied by Lowrance in order to charge the battery. Also, this charger will only charge a DR-121. It will not charge any other type of battery installed in the unit, including ni-cads or rechargeable alkalines.)

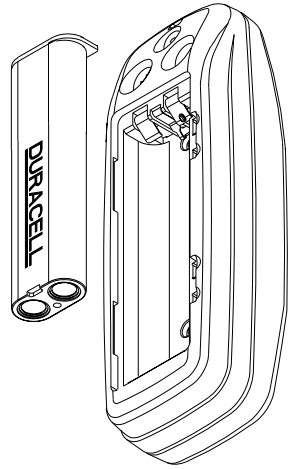

External Antenna

Although this GPS receiver is extremely sensitive, it can be used in locations where the built-in antenna simply cannot receive signals from enough satellites. An external antenna is supplied with your unit to use when conditions warrant. Usually, it's best to use the external antenna when the unit is attached to the yoke mount.

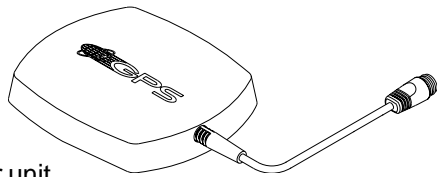

A second connector on the back of the unit is for an external antenna. The external antenna included with your unit plugs directly into this connector.

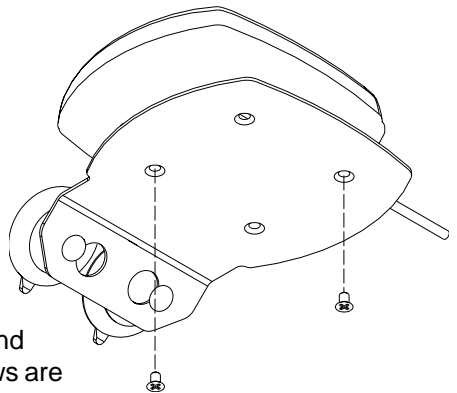

To use the antenna, first assemble the bracket, antenna, and suction cups as at right. Two screws are provided to attach the bracket to the antenna.

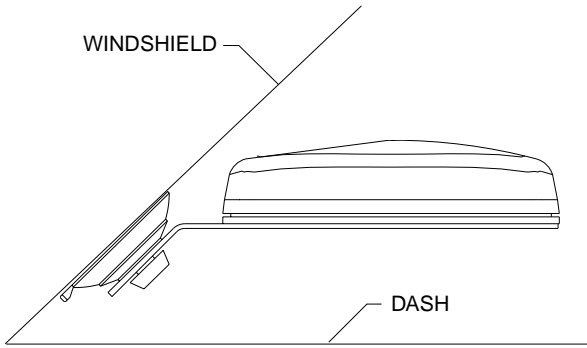

Moisten the suction cups and press them firmly against the inside of the windshield, away from your line of sight. Route the antenna's cable to the GPS receiver and it's ready for use.

YOKE MOUNTING

Included with your AirMap is a yoke mounting bracket. It secures to the yoke's shaft with a clamp. Fasten the cradle packed with your unit to the yoke mount with four 2 mm screws. Follow the instructions included with the yoke mount to assemble and attach it to your aircraft. The AirMap simply snaps into the cradle.

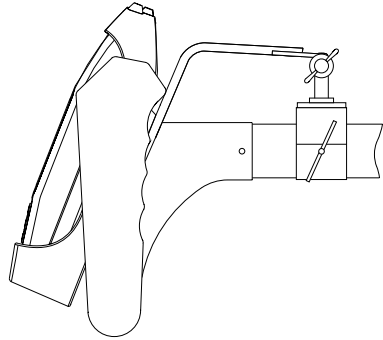

The AirMap can operate from batteries or the external power cord when it's attached to the yoke mounting bracket. To use the external power cord, simply plug one end into the power connector on the AirMap and the other end into the aircraft's cigarette lighter.

Some pilots like to keep fresh batteries in their units, even when using the external power. If the power fails, the unit will automatically switch to the batteries, thus keeping the unit on without interruption.

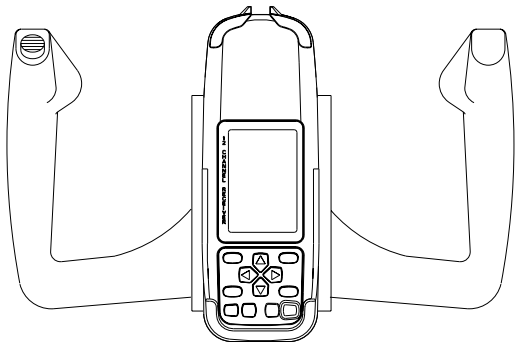

OPERATION

Keyboard

There are 12 keys on the keyboard. You navigate through the menus, adjust the chart's cursor, and enter data using the arrow keys. The five major modes of operation are accessed using the PAGES key. Press the MENU key to select or adjust a feature from a list. The Z-IN and Z-OUT keys zoom-in or zoom-out the view on the plotter screen. The ENT and EXIT keys are used to enter or clear data or screens. Save and edit waypoints using the WPT key. The PWR key turns the unit on and off. Pressing it once while the unit is operating turns on the screen's backlight. To prevent an accidental shutdown, you must hold the PWR key down for a few seconds in order to turn the unit off.

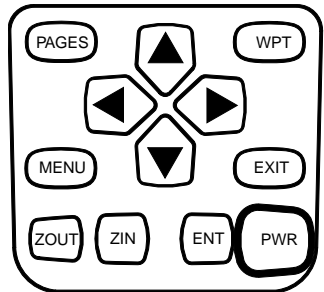

Menus

Most of the unit's features are found on "menus". You can view the menus by pressing the MENU key. This product has "Intelligent Menus". There are many menus that pertain to only the map, for example. When you press the MENU key and the plotter is showing, menu items for the plotter show in addition to the normal menus. For example, if the navigation screen is showing, and you press the MENU key, plotter menu items won't show on the list. This helps you find the needed item without scrolling through unnecessary menus.

Turning Power On

To turn the unit on, simply press the PWR key. A GPS logo screen appears, then the screen similar to the one at right appears. Read the message on the screen, then press the EXIT key to erase it or wait a few seconds and it automatically clears. The satellite status screen shown at the top of the next page appears next.

DO NOT RELY ON
THIS PRODUCT AS
YOUR PRIMARY
SOURCE OF
NAVIGATION
THE OPERATOR IS
RESPONSIBLE FOR
USING OFFICIAL
GOVERNMENT
CHARTS AND
PRUDENT METHODS
FOR SAFE
NAVIGATION
PRESS EXIT

Satellite Status Screen

This screen shows a graphical view of the satellites that are in view. Each satellite is shown on the circular chart relative to your position. The point in the center of the chart is directly overhead. The small inner ring represents 45° above the horizon and the large ring represents the horizon. North is at the top of the screen. You can use this to see which satellites are obstructed by obstacles in your immediate area if you hold the unit facing north.

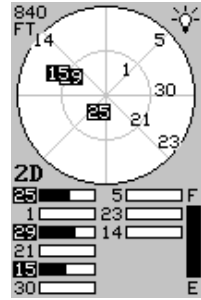

The GPS receiver is tracking satellites that are surrounded by a black box. If the satellite number is not surrounded by a box, then the receiver hasn't locked onto that satellite and it isn't being used to solve the position.

Beneath the circular graph are the bar graphs, one for each satellite in view. Although the unit has twelve channels, it dedicates one channel per visible satellite. Therefore, if only six satellites are visible, only six bar charts show at the bottom of the screen. The higher the bar on the graph, the better the unit is receiving the signals from the satellite.

The number in the upper left corner is the "expected horizontal position error" or expected error from a benchmark location. In other words, if the expected error shows 50 feet, then the position shown by the unit is estimated to be within 50 feet of the actual location. However, this number is only valid if you're using DGPS or if S/A is turned off. Due to S/A, the accuracy can only be less than 100 meters, 95% of the time, per U.S. government specifications. Although the expected error is not accurate unless you have a DGPS receiver, it does give you an indicator of the fix quality the unit currently has. The smaller the expected error number, the better (and more accurate) the fix is.

If the expected error is flashing, then the unit has not locked onto the satellites, and the number shown is not valid.

The fix indicator on the left center shows either 2D or 3D. A 2D fix means the unit has locked onto three satellites and has calculated its position. A 3D fix means the unit has locked onto at least four satellites and has calculated both the position and altitude. (Remember, it takes three satellites to determine the position - four to determine position and altitude.) If neither 2D nor 3D are showing, then the unit doesn't have the position or altitude.

A battery level indicator on the lower right side of the screen shows the approximately how much life is in the batteries. This runs from "F" (fully charged) to "E" (expired).

A light bulb indicator at the top right corner of the screen appears when the backlights are on.

Finding Your Position

Auto Search

To lock onto the satellites, the GPS receiver needs to know its current position, local time, and date. (Elevation (altitude) is also used in the equation, but it's rarely required to determine a position.) It needs this data so that it can calculate which satellites should be in view. It then searches for only those satellites. When your GPS receiver is turned on for the first time, it doesn't know what your position or elevation (altitude) is. It does know the current UTC time and date since these were programmed into it at the factory and an internal clock keeps the time while the unit is turned off. It begins searching for the satellites using the above data that it acquired the last time it was turned on. This probably was at the Lowrance factory. Since it's almost certain that you're not at the Lowrance factory, it's probably looking for the wrong satellites. If it doesn't find the satellites it's looking for after five minutes, it switches to Auto Search. The receiver looks for any satellite in the sky. Due to advanced technology, the auto search time has shrunk to about five minutes, so the longest time you should ever have to wait is ten minutes from the time you turn the unit on until it locks onto the satellites and shows a position. Once the unit locks onto the satellites, it should take less than a minute to find your position the next time it's turned on, provided you haven't moved more than approximately 100 miles from the last location it was used.

Manual Initialization

If you don't want to wait for the Auto Search, then you may be able to speed up the initialization process by using the manual initialization feature. Using this feature tells the unit its approximate position. Once it knows its location, it determines exactly which satellites should be in view and starts looking only for those satellites.

To manually initialize the unit, press the MENU key. Now press the down arrow key until the "GPS SETUP" label is highlighted. Press the right arrow key. The "INIT GPS" (Initialize GPS) label is highlighted. Press the right arrow key again. The screen at right appears. Use the arrow keys to move the crosshairs to your approximate location on the map. You may use the ZOUT key to zoom the map out. This will make it easier and faster to find your location on the map. Once you have the crosshairs on your location, press the ENT key. The unit returns to the satellite status screen.

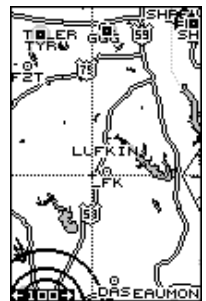

Using the manual initialization method loads a position that's close to yours into the GPS receiver. It should now have position, time, and date,

thereby giving it the data it needs to determine which satellites are in view. Once the satellites are known, the receiver searches for only those satellites, making a lock faster than an auto search method.

Position Acquisition

When the receiver locks onto the satellites and calculates a position, it shows the message “Position Acquired” on the screen. All position and navigation data flashes until the unit acquires a position. *Do not rely on any data that is flashing!* When the numbers are flashing, they represent the last known values when the unit lost it’s lock on the satellites.

(Note: The altitude data may still flash even if the unit shows a “Position Acquired” message and all other data is not flashing. The unit must be locked onto at least four satellites to determine altitude. It only takes three satellites to determine position. You can navigate with this unit if the altitude is flashing, simply ignore the altitude display until it quits flashing.)

REMEMBER, DO NOT NAVIGATE WITH THIS UNIT UNTIL THE NUMBERS STOP FLASHING!

Once the unit has acquired the satellites and is showing a fix on the status screen, or the position acquired message appears, it’s ready for use.

POSITION/NAVIGATION SCREENS

This unit has four modes: status, map, navigation, and window groups. Use the PAGES and arrow keys to switch between the different screens. The four default screens are shown below.



STATUS



NAVIGATION



MAP

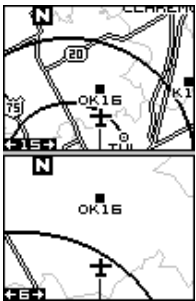

WINDOWS (GROUP "A")

To change modes, simply press the PAGES key. A screen similar to the one at right appears. Use the up or down arrow keys to change modes. (The windows mode is shown as “groups”. Group “A” is the first windows group.)

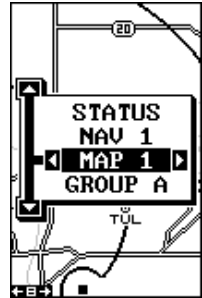

Press the right arrow key while the above menu is showing to switch between different versions of each mode. When the desired screen appears, press the EXIT key to erase the menu.

Navigation Screens

There are two different navigation screens. Nav screen number one shows a graphical view of your trip, Nav screen number 2 shows all navigation details in large digital numbers. You can also customize both navigation screens to show data other than the default. See the “Programming Boxes” section for more information.

Nav Screen #1

This screen has a compass rose that shows not only your direction of travel, but also the direction to a recalled waypoint. The navigation screen looks like the one at right when you’re *not* navigating to a waypoint. Your position is shown by the airplane in the center of the screen. Your trail history, or path you’ve taken is depicted by the line extending from the arrow. The arrow pointing down at the top of the compass rose indicates the current track (direction of travel) you are taking. This is also shown in the “TRK” (track) box in the upper right corner of the screen. On the example shown at right, the track is 24°. The current ground speed (GS) shows in the box in the lower center of this screen.



When navigating to a waypoint, Nav screen number one looks like the one at right. Bearing to the destination waypoint is in the box in the upper left corner. Bearing is also shown by the large arrow pointing up towards the compass, above the present position arrow. Distance from the present position to the waypoint (DIS) shows beneath the compass on the lower left side of the screen.

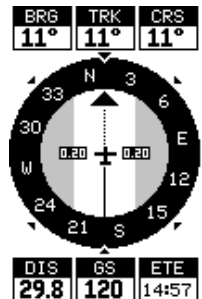

Lines on either side of the present position show the current cross track error range. Cross track error is the distance you are off-course to the side of the desired course line. The course line is an imaginary line drawn from your position when you started navigating to the destination waypoint. It's shown on the screen as a vertical dotted line. The default for the cross track error range is 0.25 mile. For example, if the present position symbol touches the right cross track error line, then you are .25 mile to the right of the desired course. You need to steer left to return to the desired course. The cross track error is also shown in the "XTK" box. In the upper right corner is the course (CRS) box showing the direction from your starting position to the waypoint. Remember, a course is a proposed path from the starting position to the destination. Track is your actual direction of travel.



A circle depicting your destination appears on the screen as you approach the waypoint as shown on the screen at right.

Nav Screen #2

This navigation screen shows all navigation information in large digital numbers. To view this screen, press the PAGES key, then press an arrow key until the "NAV1" label is highlighted. While it's highlighted, press the right arrow key. The screen shown at right appears. Press the EXIT key to erase the menu.



This screen is composed of eight digital boxes. Track (TRK) and ground speed (GS) data are all that show if you're not navigating to a waypoint. If you are navigating to a waypoint, then bearing (BRG), distance to waypoint (DIS), estimated time en route (ETE), cross track error (XTK), destination arrow, and the CDI also operate. See below for more information on the CDI.

The destination arrow shows the direction to the destination when the top of the screen is pointing in your direction of travel.

Course Deviation Indicator (CDI)

Once navigation to a destination is established, the CDI shows your distance to the left or right of the desired course. The vertical line in the box shows both the direction you must steer to get back on course and the distance to the course line. For example, if you're travelling straight to-

wards the destination, from the start, then the line stays in the center. If you drift off course to the right, the line moves to the *left*. This signifies that you need to steer to the left to get back on course. This is called “chasing the needle”. If you steer towards the line (needle), you’ll always be heading in the correct direction to get back on course.

The CDI’s range shows beneath the CDI label. On the screen at right, the CDI range is .20 mile, which is the default. You can adjust the range by selecting the “ALARMS/CDI” label on the main menu. This is also shown by the dotted lines at the far left and right side of the CDI. If the solid line is on either of the dotted lines, then you are 0.20 mile off course. Remember, if the line moves to the left, then you are too far to the *right* of the desired course line and vice-versa.

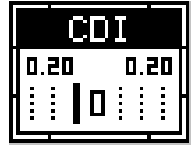

Using the CDI with a mapping screen helps you visualize your position in relation to the course. The map screen on the right shows that we are off course to the right. The vertical bar on the CDI shown above has moved to the left side, showing the direction to the desired course line. The CDI gives you a quick, easy to read visual indicator of your relationship between your direction of travel and the desired direction.

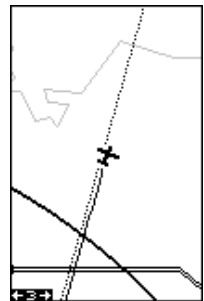

Map

The AirMap 100 has a ground map of the world built inside. This map has the majority of its detail in far southern Canada, the continental United States and Hawaiian islands, northern Mexico, the Bahamas, and Bermuda. The map screens show your course and track from a “birds-eye” view. If you’re navigating to a waypoint, the map shows your starting location, present position, course line, and destination. You don’t have to navigate to a waypoint, however, to use the map.

A complete aviation database is included using Jeppesen® data . Airports, NDBs, VORs, and other airspace information (including obstructions such as radio and TV towers) are overlaid onto the ground map.

Using the map is as simple as pressing the PAGES key, then highlighting “MAP 1”. A screen similar to the one at right appears. The airplane symbol in the center of the screen is your present position. It points in the direction you’re travelling. The solid line extending from

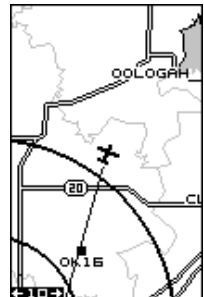

the airplane symbol is your plot trail, or path you've taken. The map's range shows in the lower left corner of the screen. In this example, the map's range is ten miles from the left edge of the screen to the right.



There are three different mapping screens. To view the other map screens, press the PAGES key, highlight the MAP label, and press the right arrow key until the desired map screen appears. Press the EXIT key to erase the menu. Map-2 (shown below) has navigation data added at the bottom of the screen, beneath the map. The data includes bearing to waypoint (BRG), track (TRK), and distance to waypoint (DIS).

Map-3 is similar to Map-2. It shows ground speed (GS), track (TRK), and the CDI at the bottom of the screen.

As you travel, the map slides past your present position, which always remains at the center of the screen. The line extending from your position shows the path you've taken.

The Z-IN and Z-OUT keys zoom-in and out all maps to enlarge or reduce their coverage area. The available ranges are: 0.1, 0.15, 0.2, 0.3, 0.4, 0.6, 0.8, 1, 1.5, 2, 3, 4, 5, 6, 8, 10, 15, 20, 30, 40, 60, 80, 100, 150, 200, 300, 400, 600, 800, 1000, 1500, and 2000 miles.

Jeppesen™ data shows at all zoom ranges, however, Lowrance has a unique method of displaying this data. If you were to turn on all airports, VORs, NDBs, and controlled airspaces at the same time without filtering the data, the map screen would become so cluttered that it would be useless. The AirMap 100 turns off virtually all aviation data at large ranges, selectively turning on more data as you zoom in closer to your present position or cursor location. The background land data also shows more as you zoom in.

Cursor

Pressing an arrow key turns on two dotted lines that intersect at the present position symbol. These lines are called a “cursor” and have many uses. To turn the cursor on, simply press the arrow key in the direction you want the cursor to move. This lets you view areas on the map that are away from your present position. The zoom-in and zoom-out keys work from the cursor’s position when it’s active - not the present position. You can zoom in on any detail, anywhere. You can also place icons and waypoints.

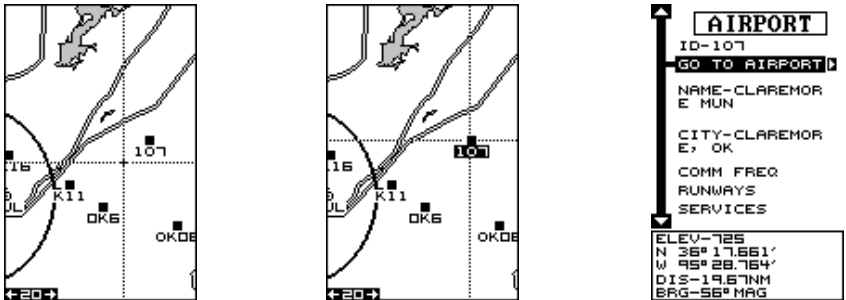

The cursor has an extremely useful feature that lets you identify airports, VOR’s, NDB’s, intersections, and user-defined waypoints. In this example, an airport is identified. First, move the cursor to the airport. When the label on the airport is highlighted, press the WPT key. The waypoint screen appears with the highlighted airport’s data showing. You can navigate to this airport by pressing the right arrow key, view other information by highlighting the “COMM FREQ”, “RUNWAYS”, or “SERVICES” labels. Press the EXIT key to erase this screen. You can select another feature in the same manner or press the EXIT key to erase the cursor. The unit centers your present position on the screen after erasing the cursor.

MAP SYMBOLS

Airports, VORs, NDBs, and Intersections

All airports are shown as a square with its identifier beneath it. Larger airports are shown the same way until you zoom in closer, then their runways become visible. Zoom in farther, and the runway numbers also appear. VOR’s are shown as a circle with a dot inside, while NDB’s have a triangle. Intersections are depicted as an “X”.

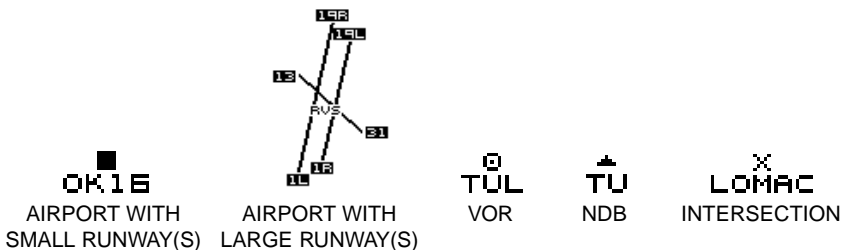

Obstructions

Your Airmap has obstruction capability. The database installed in your unit lets you see ground obstructions on the map display such as radio and television towers. The obstruction portion of the database covers all of the continental United States, Alaska, and parts of Canada, Mexico, and Bahamas.

On the screen shown at right, three obstructions are shown. Three different symbols are used to show them, depending on their height. They are:

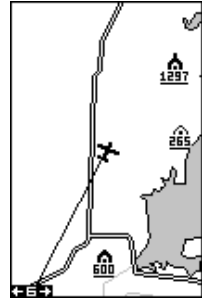

SMALL - 205 to 499 feet



MEDIUM - 500 to 999 feet



LARGE - 1000 feet and above

The elevation shows beneath the symbol. If a line is beneath the elevation, then the height is AGL, or above ground level. If no line shows beneath the height, then it is MSL or above mean sea level.

For example, this obstruction is

315 feet AGL: 

This obstruction is 315 feet MSL: 

Typically, you'll need to zoom in to a range of 40 miles or less to see the large obstruction symbols, and smaller ranges to see the larger obstruction's height and smaller obstructions. To view smaller obstruction's height, you may need to zoom in to the 5 mile range.

Obstructions are off by default. To turn them on, press the MENU key, while a map is showing, then select the "MAP-1 SETUP" label and press the right arrow key. Now select "AIR MAP OPTIONS" and press the right

arrow key. Finally, select “OBSTRUCT OPTIONS” and press the right arrow key. The screen at right appears. The defaults are: obstructions from 205 to 499 feet (shown as 200-500 on the menu) off. Obstructions 500 feet and above off. MSL defaults on. You can change any of these by highlighting the desired menu, then pressing the left or right arrow keys.

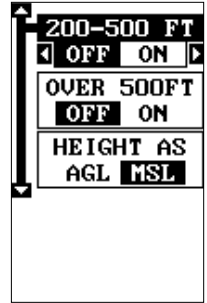

Airspace

This unit can show the following airspaces: Class B and C airspace, control zones, control areas (CTA), Terminal Control Areas (TMA), prohibited, restricted, MOA's (including training, danger, and caution areas), and alert areas.

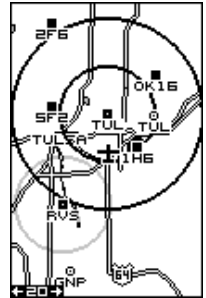

In this example, the Class C airspace surrounding Tulsa International airport (TUL) is clearly visible as two dark circles. The control zone airspace around Richard Jones (Riverside) airport (RVS) is shown in gray.

This screen shows the Eureka MOA east of Wichita, Kansas on the 80 nautical mile range.

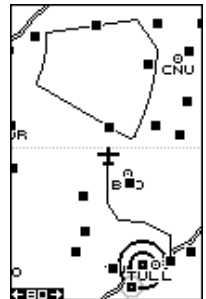

All airspace defaults are on for this unit except warning and alerts. An airspace alarm can be set that will warn you if any of the above airspaces are within a preset radius of your position. Another airspace alarm will “look-ahead” and show how soon you will cross into an airspace. See the alarms section for more information.

Airspace Status

You can view information about the airspace you're in using the airspace status feature. To do this, press the MENU key, then highlight “AIRSPACE STATUS” shown at the top of the next page.

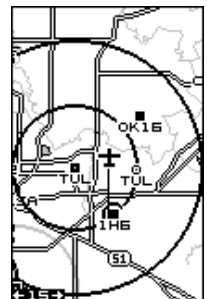



With "AIRSPACE STATUS" highlighted, press the right arrow key. The center screen above shows next. In this example, we're in Tulsa class "C" airspace. The time and distance remaining until we leave the inner ring of the airspace (assuming we keep the present track and speed) shows on this screen above the ceiling and floor of the airspace. Since we're near the center of the class "C" airspace, (see the map at the bottom of the previous page) page one shows information about the inner ring, page two shows outer ring information. To view page two, simply press a right or left arrow key. Press the EXIT key to erase the status screens.

Airspace Information

You can identify an airspace without physically entering it by using the cursor. To do this, press any arrow key while a map is showing. In this example, we're using Map 1. The cursor appears. Now move the cursor to the desired airspace as shown below left. (Note: You may have to zoom-in and/or zoom-out to view the airspace.)

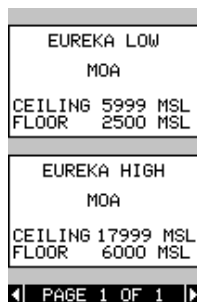
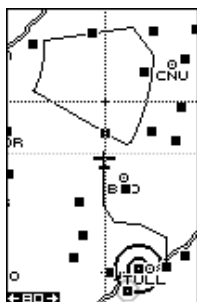

With the cursor moved to the airspace, press the MENU key. A screen similar to the one in the center appears.

Now highlight the "AIRSPACE INFO" label and press the right arrow key. A message screen appears as shown above right.

This is the information for the airspace that the cursor is resting on. If there are more pages of information about the airspace, press the left or right arrow keys to view them. To erase this screen, simply press the EXIT key. To see information about another airspace, simply move the cursor to that airspace and repeat these steps.

MAP SETUP

The map has many customization options. To change them, first press the MENU key while a map is showing on the screen. The “MAP SETUP” screen is highlighted. Press the right arrow key. A screen similar to the one at right appears.

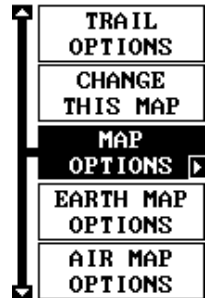

Change Maps

Changes made to the map using the options in the Map Setup is normally limited to only to the current map screen. The change can be all map screens, however, by switching the “THIS MAP” to “ALL MAPS” in the “CHANGE” menu. To do this, simply highlight the “CHANGE” label, then press the right arrow key. To switch back, repeat the above.

MAP OPTIONS

The following map options are listed under the “Map Options” menu: Map Orientation, Auto Zoom, View Destination, Range Rings, and Grids.

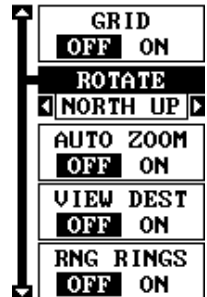

Map Orientation

By default, this receiver shows the map with north always at the top of the screen. This is the way most maps and charts are printed on paper. This is fine if you’re always travelling due north. What you see to your left corresponds to the left side of the map, to your right is shown on the right side of the map, and so on. However, if you travel any other direction, the map doesn’t line up with your view of the world.

To correct this problem, a track-up mode rotates the map as you turn. Thus, what you see on the left side of the screen should always be to your left, and so on. A course-up mode keeps the map at the same orientation as the initial bearing to the waypoint.

In the north-up view shown at right, we're travelling southeast towards camp, saved as waypoint number 14. In this view, the present position indicator appears to move towards the lower right corner of the screen.

NORTH-UP



In the track-up view, the present position moves straight towards the top of the display. A "N" shows to help you see which direction is north when the track-up mode is on. Remember, in the track-up mode, the screen rotates as you change direction. It always keeps your direction of travel (track) heading towards the top of the screen.

TRACK-UP

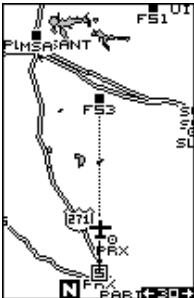

In the course-up mode, the screen is locked into your original bearing to the recalled waypoint, regardless of your track.

COURSE-UP

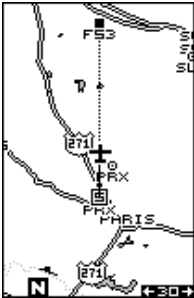

To select the desired mode, first press the MENU key, select "MAP 1 SETUP", then select "MAP OPTIONS". Finally, select "ROTATE" and press the right or left arrow key until the desired mode appears. Press the EXIT key to erase this menu.

AUTOZOOM

This receiver has an autozoom feature that eliminates much of the button pushing that competitive units force you to make. It works in conjunction with the navigation features. First, recall a waypoint. (See the waypoint section for more information on navigating to a waypoint.) Then, with the autozoom mode on, the unit zooms out until the entire course shows, from the present position to the destination waypoint (recalled waypoint). As you travel towards the destination, the unit automatically begins zooming in, one zoom range at a time, keeping the destination on the screen.

The screens below show a slice of the progression of a trip to Mangham Regional airport in Nacogdoches, Texas. Screen number one is the start and is on the 200 mile range. Intermediate stages progressively zoom in as it gets closer to the destination.

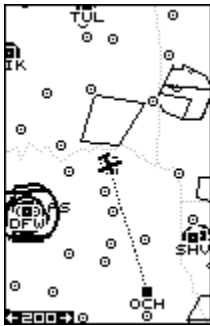

1

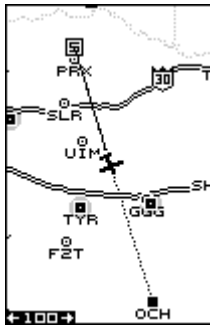

2

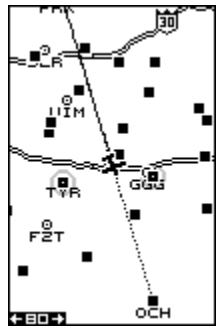

3



4

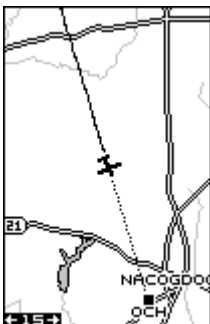

5

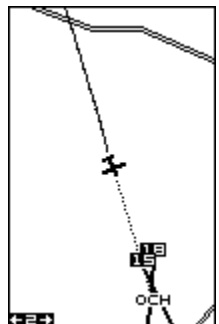

6

To use the autozoom feature, first press the MENU key, select "Map 1 Setup", then "Map Options". Highlight "Auto Zoom", then press the right arrow key to turn it on. Press the EXIT key repeatedly to erase the menus.

VIEW DESTINATION

The GPS receiver normally centers the present position on the screen and moves the map past it. If a waypoint is recalled, the unit can center the waypoint on the screen, instead of the present position. To do this, press the MENU key, select "Map 1 Setup", then "Map Options". Highlight "View Dest", then press the right arrow key to turn it on. Press the EXIT key repeatedly to erase the menus.



VIEW DESTINATION OFF



VIEW DESTINATION ON

Range Rings/Grid Lines

The map screen can be customized with rings that are 1/4 of the range and/or grids that divide the map into equal segments of latitude and longitude. To do this, press the MENU key, select "Map 1 Setup", then "Map Options". Highlight the desired option, then press the right arrow key to turn it on. Press the EXIT key repeatedly to erase the menus. A sample screen of each type shows below.

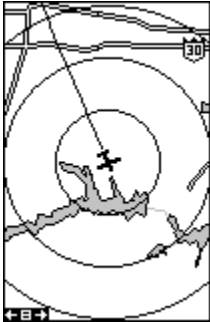

RANGE RINGS

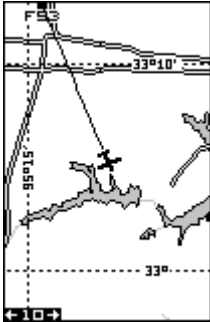

GRID



BOTH RINGS & GRID

EARTH MAP OPTIONS

The earth map consists of the built-in background map of the world. To change the Earth map options, first press the MENU key, then select the Earth Map label. Press the right arrow key. The screen shown at right appears.

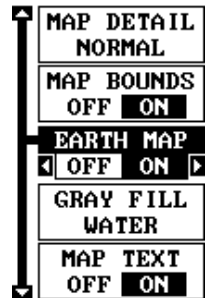

Earth Map On/Off

The background map can be turned on or off using the "Earth Map" menu. The earth map is the background map that shows on the map screens. Simply highlight the menu, then press the left arrow key to turn it off.



EARTH MAP ON

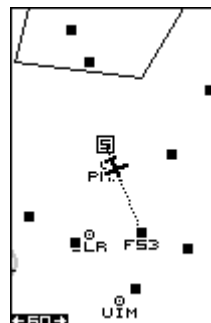

EARTH MAP OFF

Text Labels

Select "Map Text" to turn all names on the map (such as Lake Tahoe or Mississippi River) off or on. The default is "on". Press the left arrow key to turn them off.

Locations

Normally, text disappears as you zoom out. This declutters the screen, making it easier to see significant map detail. Turning "Locations" on from the earth map menu places a dot on the screen where a text label should be when the screen is zoomed out. The arrows on the screen at right show two locations where, if zoomed in, text will show. (Note: this doesn't affect air data, just the earth map.)

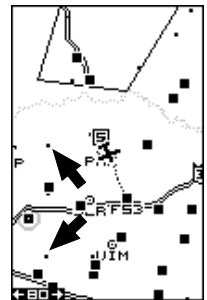

Map Detail

The detail shown on the background map diminishes as the screen is zoomed out. This prevents cluttering of the display, or overlapping of text

and graphics which can make it unreadable. There are two detail levels: normal and high. The difference between the two shows below. The screen on the left is normal detail, on the right is high detail. Both screens are on the 60 mile range. Normally, you'll only see a difference in detail when the unit is zoomed out to the 30 mile range or higher.

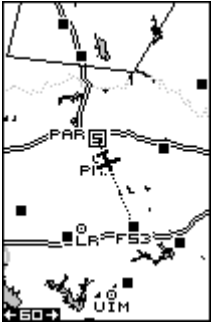

NORMAL DETAIL

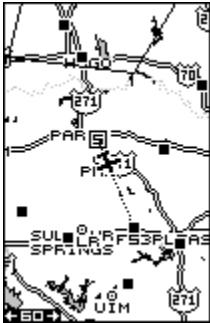

HIGH DETAIL

To change the map's detail setting, select "Map Detail" from the earth map menu, then press the right arrow key.

Gray Fill

When this unit is first turned on, all water (lakes, oceans, rivers) is filled with gray to distinguish it from land, which is clear. (See below) To make the land fill with gray and water remain clear, select the "Gray Fill" label from the Earth Map menu, then press the left arrow key. Press the EXIT key repeatedly to return to the mapping screen.

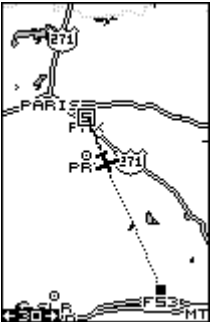

WATER FILLED WITH GRAY



LAND FILLED WITH GRAY

Normally, you'll want to fill water with gray when you're using the GPS receiver over land and fill land with gray when you're using it over water.

Map Boundaries

The Map Boundary feature shows the area that's covered by the detailed background map. The solid line on the screen at right shows the coverage area of the detail in the built-in background map. If you download SmartMap, WorldMap, or other more detailed maps, the map boundary feature will show their coverage areas, also. The default for this feature is on. To turn it off, select "MAP BOUNDS" from the "EARTH MAP" menu and press the left arrow key.

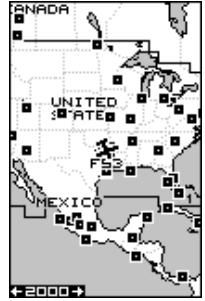

Symbols, Locations, and Contours

These features on the Earth Map menu are used when special map data is downloaded to this unit. You can turn each of the above on or off independently. They only work with the special data. See the MapSelect section for more information on downloading map data to this unit.

AIR MAP OPTIONS

You can select the aviation symbols and airspaces that you want displayed on the screen. To do this, first press the MENU key, then select "MAP-1 SETUP". From this menu, select "AIR MAP OPTIONS". A screen similar to the one at right appears.

You can turn all air data off by selecting "AIRMAP", then pressing the left arrow key. Use the up and down arrow keys to select the desired symbol, then press the right arrow key to turn it on or the left arrow key to turn it off. To turn the identifying text off on all airports, VOR's, NDB's, and intersections, select "ID'S" and press the left arrow key. You can also turn off all airports, VOR's, NDB's, and intersections from the air map options menu.

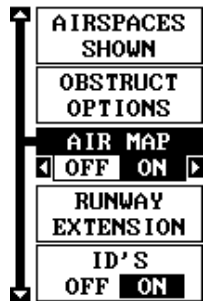

To change the airspace selections, select "AIRSPACES SHOWN". The screen shown at right appears.

Again, use the up and down arrow keys to move the box to the desired airspace that you wish to change, then press the right arrow key to turn it on or the left arrow key to turn it off.

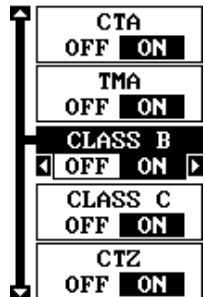

Runway Extensions

This unit can draw a line on the screen that extends the runway which makes it easier to line up on the runway during final approach. To use the extension, you must first navigate to an airport. (See the Navigation section for more details.) In this example, (shown at right) we're navigating to Mangham Regional airport in Nacogdoches, Texas. Next, select "Runways/Extensions" from the "AIRMAP OPTIONS" menu shown on the previous page. The screen shown below appears.



Now select "RUNWAY EXTENSION" on this menu. The screen below left appears.

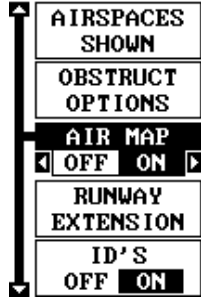

Use the left or right arrow keys to select the desired runway. In this example, we're using runway 36. When the extension appears on the desired runway, press the EXIT key to return to the map.

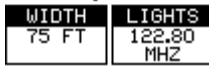
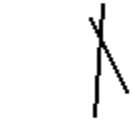
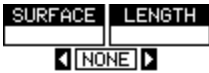

A line on the screen extends from the airport in line with the selected runway.

To turn the extension off, repeat the above steps, but select "NONE" on the above menu.

TRAIL OPTIONS

The line extending from the present position symbol is called a plot trail. You can customize the plot trail and save trails using the trail options menu. To use it, press the MENU key, select "MAP SETUP", then "TRAIL OPTIONS". The screen at right appears.



Clear Trail

To erase the current plot trail from the screen, select Clear Trail from the Trail Options menu. A message appears, asking if you really want to erase the plot trail. Follow the instructions on the screen. When the trail is erased, the unit returns to the map screen.

Flash Trail

By default, the plot trail flashes once per second. This typically makes it easier to see the plot trail against the background map. To turn the flashing off, select "FLASH TRL" from the trail options menu. Press the left arrow key to turn it off.

Update Options

By default, the plotter places a dot on the screen every 3 seconds to create the plot trail. You can change this time from once per second to once every thirty minutes. The plot trail can also be updated by distance instead of by time. The distance update rate can be set from 0.01 to once every 10 miles.

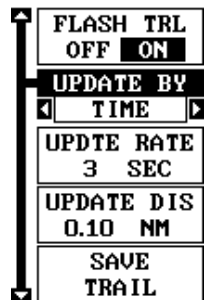

From the trail options menu, choose "UPDATE BY" to change the update rate or type. To change the rate or distance, simply select either the "UPDATE RATE" or "UPDATE DIS" menus as appropriate, use the left or right arrow keys to adjust it, then press the EXIT key to erase the menu.

PLOT TRAILS - Save Trail

This unit automatically saves the current plot trail in memory when you turn it off. You can save two other trails in memory. To save your current plot trail in a specific memory location, choose "SAVE TRAIL" from the "TRAIL OPTIONS" menu. The screen shown at right appears. Highlight the desired number that you wish to save the current trail under, (i.e. "Trail 1 or Trail 2) and press the right arrow key. Your current trail is saved. Press the EXIT key to erase this menu.

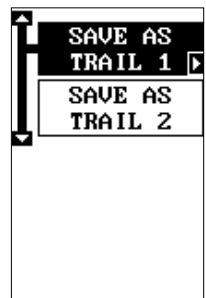

PLOT TRAILS - Trails Shown

The current plot trail shows on the plotter by default. To place a previously saved trail onto the plotter, choose "TRAILS SHOWN" from the Trail Options menu. The screen shown at right appears. Highlight the desired trail on this screen, then press the right arrow key to select it. Press the EXIT key to erase this menu. The selected plot trail shows on the plotter.

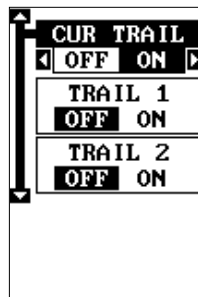

ICONS

The plotter has 28 symbols or "icons" available that can be placed anywhere on the screen. They can be used to mark airports that aren't in the database, ramps, or virtually any point of interest. An icon can be placed at your present position or at the cursor's location. However, you can't use icons for navigation.

Place Icon - Present Position

To place an icon at your present position, simply press the ENT key while the mapping screen is on. The screen shown at right appears. Use the arrow keys to highlight the desired icon. Now press the ENT key again. The mapping screen reappears with the icon showing at the position you were at when the ENT key was pressed.

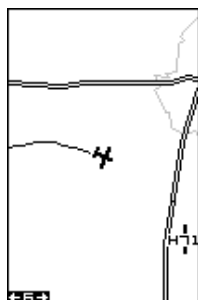

MAP-1 SCREEN
PRESS ENT KEY



SELECT ICON
PRESS ENT KEY

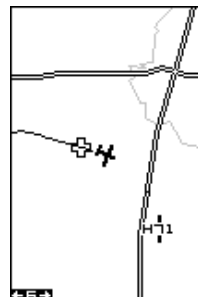

ICON PLACED
AT POSITION.

Place Icon - Cursor Position

To place an icon at the cursor's position, first use the arrow keys to move the cursor to the location that you wish to place the icon. Next, press the ENT key. Now select the icon using the arrow keys. While it's selected, press the ENT key. The map reappears with the icon placed at the cursor crosshairs. Press the EXIT key to erase the cursor. On the screens shown below, the house icon was placed at the cursor's location.



MOVE CURSOR
PRESS ENT KEY



SELECT ICON
PRESS ENT KEY



ICON PLACED AT
CURSOR POS.

Icon Options

Icons can be erased from the plotter individually, all of a specific type, or all at once. They can also simply be turned off without erasing them. To make changes to the icons, press the MENU key, then select "MAP SETUP", and finally select "ICON OPTIONS". The screen shown at right appears.

The first menu (ICONS OFF/ON) simply turns all icon symbols off or on. This doesn't erase the icons, it simply "hides" the icons from the map. You can use this feature to temporarily de-clutter the display.

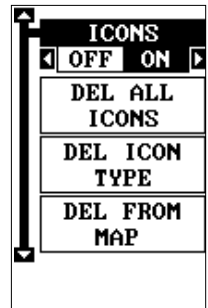

The DEL ALL ICONS selection does erase all of the icons from memory, Use this only if you want to erase all icons that have been placed on all map screens.

To erase only a certain type of icon, select the DEL ICON TYPE menu. The icon menu appears. Highlight the icon style that you want to erase from memory, then press the ENT key. The unit returns to the map screen with only the selected icons erased.

You can delete individual icons by selecting the DEL FROM MAP menu from the Icon Options menu. Once this menu is selected, the unit returns to the plotter screen with the cursor activated as shown at right. Use the arrow keys to move the cursor to the icon that you want to erase. Once the crosshairs are on top of the icon, press the ENT key. The icon is immediately erased. Press the EXIT key to erase the cursor.

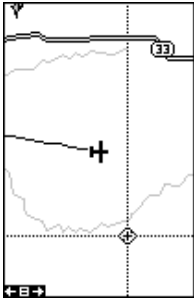

Map Downloading

The AirMap 100 has a background map of the world permanently installed inside. You can send an enhanced map from an optional IMS MapSelect CD-ROM to the unit using a personal computer.

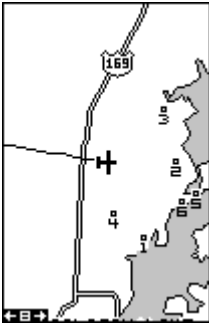

BACKGROUND MAP ONLY

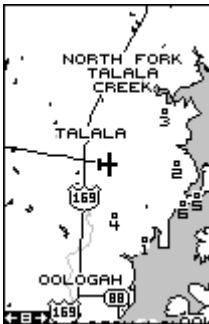

BACKGROUND MAP WITH IMS MAP

Important!

Downloading enhanced maps will erase the Jeppesen database. You can't have both an enhanced map and aviation data in the unit simultaneously.

Currently, the IMS MapSelect CD has the following databases:
IMS SmartMap™ data covers the 48 contiguous states and are broken down into 64 different mapping regions. Contained in this database are the names and locations of over 140,000 cities; 30,000 national, state and county parks; 120,000 inland bodies of water plus coastal waters out to 25 miles; as well as nearly all state and federal highways, interstates and routes.

IMS WorldMap™ data covers 35 specific regions around the globe including Canada, Europe, Indonesia and Australia. Contained in this database are the names and locations of cities, towns, provinces and states,

plus major roadways including two- and four-lane highways, inland waterways and coastal hydrography.

Coastal Navaid data covers coastal regions of the 49 U.S. States (excluding Hawaii), the District of Columbia, the Great Lakes and many large coastal rivers and other large inland lakes. Contained are approximately 60,000 marine navigation aids. Each navigation aid is displayed as a small symbol, with information useful to the navigator (including light type (flashing or continuous), light color, and other aid markings) below the symbol.

To use one of these, install the software from the CD-ROM onto your PC compatible computer according to the instructions supplied with the CD. Next, connect the cable supplied with this unit from a serial port on the computer to the GPS receiver. Now turn the unit on and adjust the communication port baud rate to its highest level (Press MENU - SYSTEM SETUP - COM PORT SETUP). Set the parity to "none" and 8 data bits.

Start the GDM-16 program on the computer. Click on the "GPS" label, then click on "Options". Select the com port that the GPS cable is connected to and click "OK". Now click on the "GPS" label, then "Initialize". This starts the communication between the GPS unit and the computer. If the communications fail, try switching the baud rate on the AirMap 100 to a lower setting. Once the communications are established, click on the "Map Select" tab. Choose a memory partition to download a map into, then choose a map. If you have problems, click on "Help". There is extensive help available on the GDM-16 program.

TRANSFERRING MAP DATA

Using the GDM Software, you may transfer up to two maps of your choice to your GPS Unit.

1. Click on the MapSelect Tab.
2. Select a map by clicking on the desired database button (IMS SmartMap, IMS WorldMap, or Coastal Nav aids). A map appears on the screen . Click the desired area that you want to download to the GPS unit.
3. Select a memory partition by clicking on Memory Partition 1 or 2.
(Note: Any data already present in a selected memory partition will be overwritten. When transferring map data larger than 1 megabyte, both memory partitions are automatically selected.)
4. Click the Transfer Map Data Button.

A status bar appears on both the PC and the GPS unit's screen. When the bar disappears, the transfer is complete. You'll be able to see the difference when the unit is zoomed in to ranges of ten miles or less.

WINDOWS

The windows feature provides ten different data screens chosen for their broad range of navigation information and ease of use.

To use the windows feature, press the PAGES key, then highlight the "GROUP A" label at the bottom of the screen. Group A is visible in the background when you switch to the windows group. Press the left or right arrow key to switch between all off the groups. When the desired group appears, press the EXIT key to erase the Pages menu. A summary of the groups follows. Note that many of the groups have navigation data that require navigation to a waypoint in order to show data. See the waypoint section for information on waypoint navigation. All of these groups can be rearranged. See the reprogramming section for more information.



Group A

This screen has two maps, one above the other. Each map works separately from the other. For example, the top map has autozoom turned on, while the bottom map doesn't. To zoom in or out on the bottom map, simply press the ZIN or ZOUT keys. The main menu also has selections for the upper map and lower map setups.



GROUP A



MAIN MENU

Group B

This screen has a map in the track-up mode on the top half with bearing (BRG), distance to go (DIS), track (TRK) and the CDI on the lower half. (See page 10 for an explanation of the CDI.)



Group C

A half screen map in the track-up mode again appears at the top. The CDI shows in the middle of the screen. Your present course (CRS) shows at the top of the CDI. Track (TRK) and distance to go (DIS) show at the bottom of the screen.

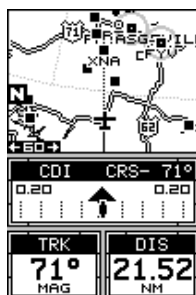

Group D

This screen is the same as group C except ground speed (GS) replaces distance to go (DIS) in the lower right corner.

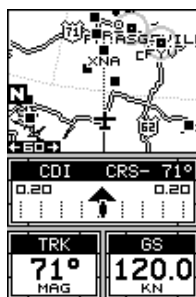

Group E

A CDI combined with a digital boxes makes up this screen. Beneath the CDI are bearing (BRG), distance to go (DIS), track (TRK), ground speed (GS), and altitude (ALT).

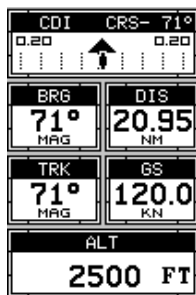

Group F

This screen shows two position windows. Each can show the position in different formats. (See Position Format in the GPS Setup section for more details.)

POSITION	
LATITUDE	N 36°12.142'
LONGITUDE	W 94°43.016'

POSITION 2	
LATITUDE	N 36°12.142'
LONGITUDE	W 94°43.016'

Group G

The group G screen shows DGPS information. There must be a DGPS receiver connected to the unit in order to use this screen.

The DGPS corrections at the top of the screen shows a list of the satellites in view. The satellite's number is followed by an identifier showing its status. They are as follows:

DGPS CORRECTIONS			
2	OK	19	OK
7	OK	9	NA
27	OLD	14	NA
15	OK		
4	OK		
26	OK		

DGPS STATUS	
DGPS ON	
FREQUENCY	ID
299.0 KHZ	162
BIT RATE	SNR
200 BPS	30 DB
SIGNAL	AGE
100	2 SEC

OK DGPS corrections are in use by GPS receiver and corrections are available.

OLD Unit hasn't received corrections in last 60 seconds.

NA No correction available.

The DGPS station's ID number, frequency, bit rate, signal strength, signal to noise ratio (SNR), and time since the GPS receiver received the satellite corrections (AGE) all show at the bottom of this screen.

Group H

This is a time screen. An analog clock shows at the top, followed by a digital clock showing your local time. The clock's alarm setting shows in this window, also. UTC time shows at the bottom of this screen. (UTC is the time at the prime meridian. It used to be called GMT.) To set the clock alarm, first press the MENU key, then select "CLOCK ALM SETUP" and press the right ar-

CLOCK 3:30:13 PM ALARM OFF
UTC 15:30:13

row key. The screen shown below left appears. Now press the right arrow key. The screen below center appears. Using the arrow keys, enter the alarm's time. Press the ENT key. The unit returns to the clock alarm menu.

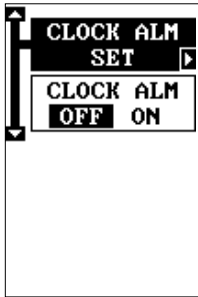

CLOCK ALARM MENU

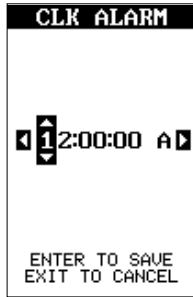

CLOCK ALARM ADJUST MENU

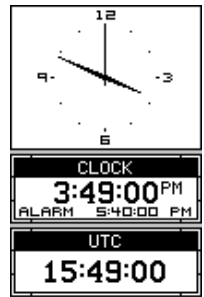

CLOCK ALARM SET

Highlight the “CLOCK ALM OFF ON” menu and press the right arrow key to turn it on. Press the EXIT key to erase the menus. The unit returns to the group with the alarm’s time showing in the clock’s window.

Group I

This group has estimated time enroute (ETE) at the top of the screen, a trip timer, estimated time of arrival (ETA), and the digital clock.



The trip timer measures the total time you have been travelling. It starts counting when you exceed a preset speed. The default is 5 miles per hour. You can adjust this time from zero to 200 m.p.h.. To do this, press the MENU key, then select “TRIP TIMER SETUP” menu. The screen at right appears. Highlight the “START GS” label, then press the left or right arrow keys until the desired speed appears. Press the EXIT key to erase this screen.

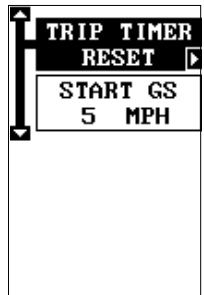

TRIP TIMER MENU

Group J

There are three timers on this screen and an odometer (TRIP METER). The trip timer is described in group I. The trip meter measures the distance you've travelled since it was last reset. To reset the trip meter, press the MENU key, then select "TRIP METER RESET" and press the right arrow key. The unit returns to Group J with the trip meter reset to zero.



The up timer starts at zero and counts up. The up timer also has an alarm. The down timer starts from a user setting and counts down to zero.



MAIN MENU



UP TIMER MENU

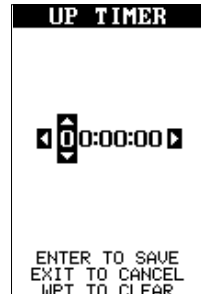

UP TIMER SET

To start a timer, first press the MENU key, then highlight the desired timer setup menu. In this example, we're using the count up timer, so the UP TIMER SETUP was selected. Now press the right arrow key. A screen similar to the one above center appears. To start the timer, simply highlight the "UP TIMER" menu, then press the right arrow key. To reset the timer to zero, select the "UP TIMER RESET" menu. The up timer has an alarm that can be set to sound at a preset time. (For example, one hour from now, three hours, etc.) To set the alarm, highlight the "UP TIMER ALM SET" and press the right arrow key. The screen at the upper right appears.

Using the arrow keys, highlight the first number in the time that you want to set. (The time is in hours, minutes, and seconds) Now press the up or down arrow keys until the desired number shows. Continue until the time shown in the display is correct, then press the ENT key. The unit returns to the timer menu screen. To turn the alarm on, highlight the "UP ALARM" label. Press the right arrow key. Press the EXIT key to erase the menu. The time you set shows in the "UP TIMER" box. The timer continues

counting until you stop it. When it reaches the alarm's time setting, a tone sounds. Press the EXIT key to shut the alarm off.

The countdown timer starts from a time that you enter and counts down to zero. (Note: When the countdown timer reaches zero, it begins counting *up* until you press the EXIT key. This tells you how long it's been since the alarm sounded.) Use the "DOWN TIMER SETUP" menu to adjust the countdown timer and reset it to zero.

Reprogram Window Groups

All of the windows groups can be customized. The changes you make to the groups will remain in memory, even if all power is removed from the unit. You can, however, return the groups to the factory settings using "Reset Groups" on the system setup menu.

To customize a group, first switch to the group that you wish to change. For this example, group "B" is used as shown at right. Next, press the MENU key, then select "REPROGRAM GROUP". The screen shown at the bottom left corner of this page appears.



The first window appears at the top of this screen. To select a different window, press the right or left arrow keys until the desired window appears. To add it to the group, simply press the down arrow key. Continue adding windows to the group in this manner until the group is filled with windows. As you add windows to the group, their relative position on the screen is represented by boxes in the lower right side of this screen. When the screen is filled with windows, the unit automatically saves your reprogrammed group and returns to the group, as shown at the top of the next page.

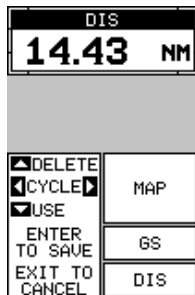



If you finish selecting windows before filling the group with windows, press the ENT key. To leave the reprogramming menu without saving the changes, simply press the EXIT key. In this example, the finished group “B” looks like the one at right.

Reprogram Boxes

The digital boxes on MAP 2 and 3 and both NAV screens can be reprogrammed, changing the informations shown by the boxes.

To customize a screen, first switch to the screen that you want to customize. Map-2 (shown at right) is used in this example. Next, press the MENU key, then select the “Reprogram Boxes” menu. The screen shown below left appears.



This is the MAP-2 edit screen. The “BRG” box near the left corner flashes, which means it’s ready for change. If you don’t want to change this box, simply press the left or right arrow key to move to the box that you do want to change. In this example, we will change the bearing (BRG) box to

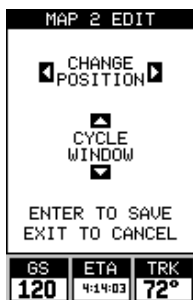
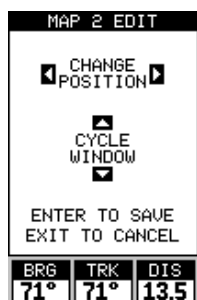

ground speed (GS). To do this, simply press the up or down arrow key while the box is flashing. The box changes each time the arrow key is pressed. When the desired box appears, then you can change another box or save your changes by pressing the ENT key. If you want to leave this screen without saving the changes, simply press the EXIT key. In this

example, we simply changed the BRG to GS, then pressed the ENT key. The screen on the far right on the previous page is the final version. Use this same method to change the NAV screens.

RESET GROUPS

To restore all window groups and boxes on the navigation and plotter screens to their factory settings, first press the MENU key, then highlight the “SYSTEM SETUP” label and press the right arrow key. Now highlight the “RESET GROUPS” label on this menu. Press the right arrow key. A message appears, asking if you really want to do this. Press the right arrow key for yes, or the left arrow key to exit without resetting the groups.

DATABASES

Thanks to the Jeppesen database and the GPS receiver’s ability to save locations in memory, (waypoints) you can navigate to virtually any location. The AirMap 100 can also store up to 750 user waypoints. You can store your present position, the cursor’s location, or enter latitude/longitude positions as waypoint locations.

The Jeppesen database contains airport, VOR, NDB, and intersection locations, plus pertinent airport data such as com frequencies, runway information, and services (fuel availability, repairs, oxygen, etc.)

You can also create routes composed of any airport, VOR, NDB, intersection or your own waypoints in any combination.

Aviation Database

To use the database, first press the WPT key. The screen shown at right appears. This is the User Waypoint screen. You’ll use this screen to store and recall your own locations. Now press the up arrow key. This moves the black box to the “USER WPT” label at the top of the screen. Pressing the right arrow key repeatedly switches to each of the database screens in the order shown at the top of the next page.



```

USER WPT
WPT# 1
GO TO WPT
NAME-----
WPT LIST
CREATE WPT
EDIT POSITION
EDIT NAME
EDIT SYMBOL
DELETE WPT
MOVE WPT
WPT TO QUICK SAVE
-----
N ---'
W ---'
DIS---- NM
BRG---- MAG

```

USER



```

AIRPORT
ID-00M
GO TO AIRPORT
NAME-THIGPEN
CITY-BAY SPR
NGS, MS
COMM FREQ
RUNWAYS
SERVICES
ELEV-351
N 31° 57.226'
W 89° 14.070'
DIS-413.4NM
BRG-118° MAG

```

AIRPORT



```

VOR
ID-ABA
GO TO VOR
NAME-ARUBA
CITY-ARUBA
FREQ-112.50 MHZ
N 12° 30.523'
W 89° 55.456'
DIS-198NM
BRG-123° MAG
REGION-ARUBA AND
NETHERLANDS ANT
ILLES

```

VOR

```

NDB
ID-1A
GO TO NDB
NAME-WILLIAMS
HARBOUR
CITY-WILLIAMS
HARBOUR, NF
FREQ- 373.0 KHZ
N 52° 33.533'
W 55° 46.933'
DIS-1965NM
BRG-42° MAG
REGION-CANADA

```

NDB



```

INT
ID-0BYL
GO TO INT
N 58° 31.917'
W 100° 00.000'
DIS-136NM
BRG-350° MAG
REGION-CANADA

```

INT

To find a particular airport, VOR, NDB, or intersection, first switch to the appropriate database. In this example, we'll use the airport database.

Suppose we're planning a trip to Fort Smith Regional airport in Fort Smith, Arkansas. There are three ways to find this airport in the AirMap's database. You can find it by searching through the airport identifiers (ID), airport name, or city. In this example, we know the airport identifier is FSM, so we'll highlight the "ID" label by pressing the down arrow key once. Now press the right arrow key. The screen at the top of the next page appears next.

```

AIRPORT
ID-00M
GO TO AIRPORT
NAME-THIGPEN
CITY-BAY SPR
NGS, MS
COMM FREQ
RUNWAYS
SERVICES
ELEV-351
N 31° 57.226'
W 89° 14.070'
DIS-413.8NM
BRG-116° MAG

```

Select the first letter in the identifier by pressing the up or down arrow keys until the letter “F” appears in the “ID” field. When it does, press the right arrow key once. This moves the selector to the second number in the identifier field. Again, press the up or down arrow keys until the letter “S” appears.

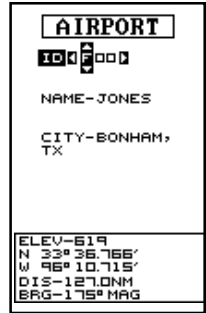

Finally, press the right arrow key one more time, moving the selector to the last number in the “ID” field, then press up or down arrow keys until the letter “M” appears. The screen should look like the one at right.

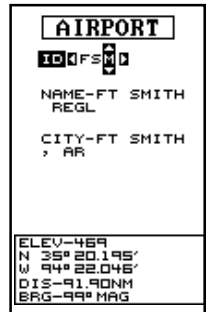

You can find an airport by using the airport name (name) or city fields the same as the ID field. Simply move the black box to the desired label, then use the arrow keys to select the name.

After you've found the airport, press the EXIT key. The screen shown at right appears.



At the bottom of the screen is the airport's elevation, which in this case is 469 feet. Beneath this is the airport's position, and at the very bottom of this screen in the distance and bearing from your present position to the airport.

Communication Frequencies

To view the communication frequencies used at the selected airport, press the down arrow key and move the black box to the “COMM FREQ” label, as shown at right. Now press the right arrow key. The screen shown at the top of the next page appears.



This is the communication frequencies screen. In this example, all applicable com frequencies for Fort Smith Regional airport are shown. Also, this airport has more frequencies that can be shown on one page. Press the left or right arrow keys to view the rest of the radio information. When you're finished with this screen, press the EXIT key. The unit returns to the previous database screen.

COMM FREQUENCIES	
ATIS	126.30 MHZ
APPROACH	124.55 MHZ
APP/DEP	125.40 MHZ 075°-255°
APP/DEP	120.90 MHZ 256°-074°
TOWER CTAF PCL	118.30 MHZ
◀ PAGE 1 OF 2 ▶	

Runways

To view the runway information, press the down arrow key on the airport database screen shown at the bottom of the previous page until the black box is on the "RUNWAYS" label, then press the right arrow key. A screen similar to the one at right appears.

SURFACE	LENGTH
HARD	8000 FT
◀ (7) (25) ▶	
WIDTH	LIGHTS
150 FT	118.30 MHZ

The active runways available at the time of your database are shown in the center of the screen. Data for each runway is shown at the top and bottom of the screen. In the example screen shown above, runway 7 - 25 has a hard surface, is 8000 feet long and 150 feet wide. It also has lights which are activated on 118.30 MHz.

To view the data for the other runway, press either the right or left arrow key. The screen shown at right appears. Now information for runway 1 - 19 is shown.

SURFACE	LENGTH
HARD	5000 FT
◀ (1) (19) ▶	
WIDTH	LIGHTS
150 FT	118.30 MHZ

If the airport has more than two runways, simply keep pressing the right or left arrow keys until the desired runway appears.

When you're finished with this screen, press the EXIT key to return to the airport database screen.

Services

To view the services available at the airport, highlight the "SERVICES" label on the AIRPORT main menu shown at the bottom of the previous page, then press the right arrow key. The screen at right shows. After viewing the information, press the EXIT key.

SERVICES
OXYGEN NOT AVAILABLE
REPAIRS AVAILABLE
JET FUEL AVAILABLE
AUGAS AVAILABLE
MOGAS NOT AVAILABLE
UNKNOWN FUEL NOT AVAILABLE

OTHER AVIATION DATABASES

The VOR, NDB, and intersection databases work the same as the airport. Simply switch to the desired database, highlight the ID, name, or city (where applicable) and select the location you wish to view. When you're finished with these screens, press the EXIT key to erase them.

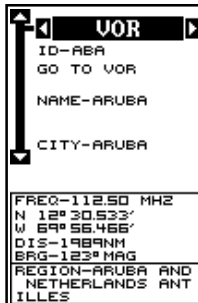

USER DATABASE - WAYPOINTS

This GPS receiver gives you the ability to create your own database of locations, called "waypoints". You can save your present position, cursor position, or enter a coordinate and save it as a waypoint. For example, you may wish to store the location of your parked car as a waypoint before starting on a hike. When you want to return to the car, all you have to do is recall the waypoint and the unit will show distance and bearing from your present position to the car. This unit stores up to 750 waypoints.

Waypoint Menu

With few exceptions, in order to save, modify, or recall a waypoint, you'll use the waypoint menu, shown at right. The current waypoint number shows at the top of the screen. Its name appears beneath the "GO TO WPT" label. The waypoint's position, distance and bearing from your present position to the waypoint, and the date and time the waypoint was saved show at the bottom of the screen. It's icon shows just to the right of the distance and bearing. In short, all of the detail about the waypoint shows on this screen.



Saving Your Present Position as a Waypoint (Quick Save Method)

To save your present position, simply press the WPT key twice. Your current position is placed into the first available waypoint number on the list. A message appears on the display telling you the waypoint number it just used. This also momentarily places you in the waypoint menu. Anytime this menu is showing, simply press the WPT key once and the unit will store your present position on the waypoint list. In this case, waypoint number one was assigned when the WPT key was pressed.



Saving The Cursor Position as a Waypoint

When the cursor is showing on the map and you press the WPT key twice, the cursor's position is placed into the first available waypoint number. In the example screen shown below, the cursor is placed at the desired location. Pressing the WPT twice causes waypoint number two to be placed at the cursor's crosshairs. (Waypoint 2 was the next available waypoint number.) A message appears on the display telling you the waypoint number it just used. Wait a few seconds and the menu will clear automatically. Press the EXIT key to erase the cursor.

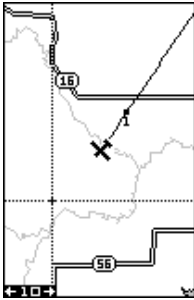

MOVE CURSOR TO DESIRED LOCATION

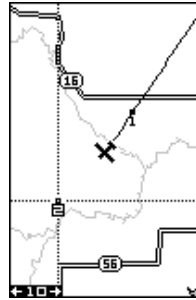

PRESS WPT KEY TWICE

Saving Your Present Position as a Waypoint (Select Number Method)

The method shown previously doesn't let you choose the waypoint number. You can pick the waypoint number, then save your present or cursor position. To save your present position, press the WPT key once. (If you're saving the cursor position, first move the cursor to the desired location, then press the WPT key.) A screen similar to the one at right appears.

Highlight the "WPT" label near the top of the screen. Press the right or left arrow keys until the desired waypoint number appears that you wish to save your present (or cursor) location under. Waypoint number 4 is used in this example. Now select "CREATE WPT". A screen similar to the one at right appears. Finally, highlight "CURRENT POS" and press the right arrow key. The unit returns to the waypoint screen with the position saved under the selected waypoint number.

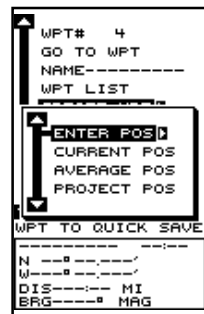

Saving a New Position

To save a position other than the cursor's or the present position as a waypoint, first select the waypoint number as described on the previous page. Next, select "CREATE WPT". The screen shown at the bottom of the previous page appears. Select "ENTER POS". The screen shown at right appears. Using the arrow keys, enter the latitude and longitude of the position that you want to save. (Note: latitude and longitude is the default, however if UTM or other position format is in use, this screen will let you enter the position in the format that's currently in use.)

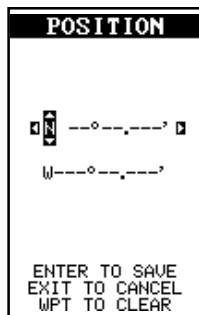

Waypoint Averaging

Although electronic position finding devices such as this one show the position in precise digital numbers, there is some ambiguity in the displayed position. With position pinning turned off, you can see this by watching the position displayed on the unit move while you're standing still. This is due to many factors; SA, atmospheric conditions, the number of satellites being tracked and their location relative to your position, and so on.

However, even with SA turned on, this GPS receiver can show surprisingly accurate position information. If you wish to increase the accuracy of a saved position, use the waypoint averaging method. This method requires the unit to remain untouched at the location that you want to save, preferably for at least one hour. Longer times will result in a better position. The unit averages all of the positions reported by its GPS receiver, resulting in typically higher position accuracy.

To use this feature, first press the WPT key and select a waypoint number, then select "CREATE WPT". The screen at the bottom of the previous page appears. Now select "AVERAGE POS". The screen shown at right appears. Your present position shows at the top of the screen. A box with a plotter graphically shows the movement of your average position. The number of positions or points taken appears beneath the plotter. The position is updated once per second. Now place the unit where it has an unobstructed view of the sky. At the end of the position gathering time, press the ENT key to save the averaged position.

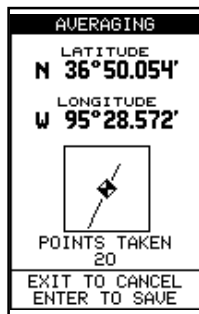

Project a Waypoint

You can save a waypoint even if you don't know its position or location on the map. This unit lets you project the location of a waypoint from a known waypoint using only bearing and distance from the known waypoint. This is useful if you don't know the latitude/longitude of a location, but you do know the distance and bearing from a saved waypoint or your own position.

(Note: To project a waypoint from your present position, you must first save your present position as a waypoint.)

To use this feature, press the WPT key, then select a waypoint number that you want to save the projected waypoint under. Waypoint 5 is used in this example. Now select "CREATE WPT". Finally, select "PROJECT POS". The screen shown above appears.

The unit needs a location (reference waypoint) to project the new waypoint from. The default reference is waypoint number one. Highlight the "REFERENCE WPT" label on the Project WPT menu and press the right arrow key. The screen above right appears. Select a waypoint using either the waypoint number, or waypoint list. When you've chosen the waypoint, highlight the "SET REFERENCE" label and press the right arrow key. The unit returns to the Project WPT screen shown at right. The starting waypoint you chose shows in the middle of this screen. Now set the distance from the starting waypoint to the projected waypoint by highlighting the "SET DISTANCE" label and pressing the right arrow key. Use the arrow keys to set the distance, then press the ENT key when you're finished. The unit returns to the Project WPT screen. Now enter the bearing from the starting waypoint to the projected waypoint by selecting "SET BEARING" from the Project WPT screen. Once you've entered the bearing, the unit returns to the Project WPT screen with the distance and bearing showing at the bottom of the screen, as shown at right. In this example, a distance of 10.5 miles and a bearing of 164° was used. Now press the ENT key. The unit saves the projected location under the waypoint number that you picked at the beginning.

PROJECT WPT	
↑	REFERENCE WPT ▶
	SET DISTANCE
	SET BEARING
↓	
REFERENCE	
WPT #1	
NAME-WPT 001*	
N 35°43.733'	
W 96°11.204'	
DESTINATION	
DIS-0.00 NM	
BRG-0° MAG	
ENTER TO PROJECT	
EXIT TO CANCEL	

USER WPT	
WPT# 1	
SET REFERENCE ▶	
NAME-WPT 001*	
WPT LIST	
CREATE WPT	
EDIT POSITION	
EDIT NAME	
EDIT SYMBOL	
DELETE WPT	
MOVE WPT	
↓	
14-MAR-98 5:33 P	
N 35°43.733'	
W 96°11.204'	
DIS- 2.58 NM	
BRG- 29° MAG	

PROJECT WPT	
↑	REFERENCE WPT
	SET DISTANCE
	SET BEARING ▶
↓	
REFERENCE	
WPT #1	
NAME-WPT 001*	
N 35°43.733'	
W 96°11.204'	
DESTINATION	
DIS-10.50 NM	
BRG-164° MAG	
ENTER TO PROJECT	
EXIT TO CANCEL	

USER WPT	
WPT# 5	
GO TO WPT	
NAME-WPT 005*	
WPT LIST	
CREATE WPT ▶	
WAYPOINT CREATED	
MOVE WPT	
↓	
WPT TO QUICK SAVE	
14-MAR-98 5:48 P	
N 35° 33.427'	
W 96° 08.732'	
DIS- 8.86 NM	
BRG-152° MAG	

SELECTING A USER WAYPOINT

In order to edit or navigate to a user waypoint, you must first select it. There are three ways to do this: by waypoint number, waypoint list, or search by name. All selection methods are on the user waypoint menu.



Waypoint Number

To select a waypoint by its number, simply highlight the "WPT" label at the top of the waypoint menu, then press the left or right arrow keys until the desired waypoint number appears.

Waypoint List

The waypoint number selection method forces you to scroll through all waypoint numbers, whether there's a location saved in them or not. The waypoint list is composed only of saved waypoints. To use the list, select "WPT LIST" from the waypoint menu. The screen shown at right appears. The names of all waypoints stored in memory show on this list. Simply highlight the desired waypoint and press the right arrow key to select it. The waypoint menu reappears.

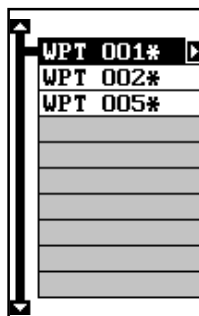

(Note: When created, a waypoint is given a default name designated by an asterisk (*). Default names are not shown on the map. The waypoint number is shown until it's renamed.)

EDITING A WAYPOINT

You can customize a waypoint by giving it a name or change it's position or icon. To do this, first press the WPT key. The waypoint screen appears. Follow the instructions below for each item.

Edit Position

Any latitude/longitude can be assigned to any waypoint by manually entering it using the keyboard. First select the waypoint number that you want to save a position under from the waypoint menu. Next, highlight "EDIT POSITION" and press the right arrow key. The screen shown at right appears. Using the left and right arrow keys, highlight each number in the position and change it using the up and down arrow keys. When you're ready to save this position and return to the waypoint screen, press the ENT key. Note: You can also use this method to change the position of an existing waypoint.

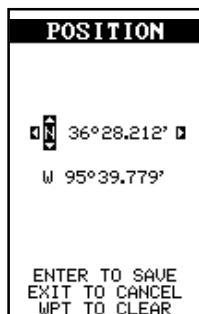

Edit Name

You can assign a name to each waypoint. The name can have up to eight characters. To do this, first select the waypoint that you wish to name, then choose "EDIT NAME" from the waypoint menu. A screen similar to the one at right appears.

Press the up or down arrow keys to select the first letter in the name. Press the right arrow key to highlight the next position in the name. Repeat this sequence until you've entered all of the letters in the waypoint name. Press the ENT key to accept this name, the WPT key to erase all characters in the name, or the EXIT key to leave this screen without saving any changes.

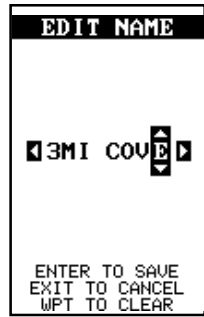

Edit Icon

To change the icon assigned to a waypoint, first select the waypoint, then choose "EDIT SYMBOL". The screen at right appears. Use the arrow keys to select the icon that you want to assign to the waypoint, then press the ENT key. The waypoint now has the new icon.



NAVIGATION

The AirMap 100 makes it easy to navigate to any location. All you have to do is select the location from the database, then highlight the "GO TO" label on the waypoint screen and press the right arrow key. The unit immediately shows navigation information to the waypoint on all navigation, map, and windows screens.

In this example, Halliburton field in Duncan, Oklahoma was recalled. It's 142 nautical miles from our present position on a bearing of 222°. To do this, we simply pressed the WPT key, selected the AIRPORT database, then selected Haliburton field. Next, the "GO TO AIRPORT" label was selected and the right arrow key pressed. The unit returned to the mapping screen that was in use before we pressed the WPT key, (shown at right) which happened to be MAP-2.



Navigating to a cursor location

This unit lets you navigate to a location without storing it in the waypoint database by using the map and cursor. To do this, first switch to a map. Now move the cursor to the location that you want to navigate to. Next,

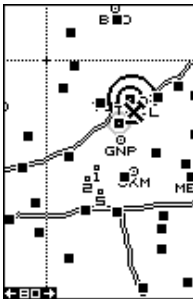

MOVE CURSOR TO DESIRED LOCATION

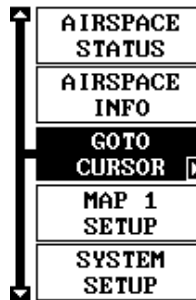

PRESS MENU KEY, THEN PRESS RIGHT ARROW KEY

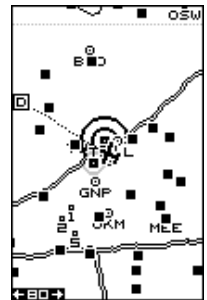

NAVIGATING TO CURSOR POSITION

press the MENU key. A new, highlighted menu appears on the list: "Go To Cursor". Press the right arrow key. It now shows navigation data to the cursor location (shown as "D" on the map). See the screens below.

Navigating to a Waypoint using the Map

The unique "birds-eye" view used by the map gives you an easy way to navigate to a waypoint. On the map screen shown at right, the airplane is your present position. The box with the "S" in it was your starting location when the waypoint was recalled. The dotted line is called a course line and is the shortest path from the starting location to the destination. The "D" on the map screen at the top of this page is the cursor destination, when the cursor position is used as a destination. (When an aviation database is used as the destination, it's designator will show instead of the "D".) If you follow the course line, you'll reach the destination, covering the shortest distance in the least time.

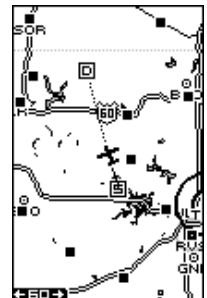

CAUTION!

The AirMap 100 does NOT take land features, altitudes, restricted or prohibited areas, or any other feature into account when it projects the track line on the screen. Therefore, you must use care when navigating on the track line and avoid any object that may be in your path to the destination.

OTHER WAYPOINT OPTIONS

Move a Waypoint

You can move all information from one user waypoint number to another to help organize the waypoints. In this example, we'll move all of the information in waypoint number 1 to waypoint number 10. To do this, highlight the "MOVE WPT" on the user waypoint screen and press the right arrow key. The screen shown at right appears. The "From" label is highlighted at the top of the screen. Press the right arrow key until the waypoint number that you want to move appears. In this example, we selected waypoint number 1. Now press the down arrow key once to highlight the "To" label. Press the left or right arrow key until the number that you want to move the waypoint to appears. Again, in this example, we chose to move waypoint number 1 to waypoint number 10, so we pressed the right arrow key until "10" appeared. As you can see on the screen above, waypoint number 1 is showing in the "From" box. Now press the ENT key. The "From" box is now empty and the "To" box has waypoint number 10.

MOVE WAYPOINT	
FROM WPT#	1
TO WPT#	10
FROM WPT #1	
WPT 001*	
N 36°28.212"	
W 95°39.779"	
TO WPT #10	
ENTER TO MOVE	
EXIT TO CANCEL	

MOVE WAYPOINT	
FROM WPT#	1
TO WPT#	10
FROM WPT #1	
TO WPT #10	
WPT 010*	
N 36°28.212"	
W 95°39.779"	
ENTER TO MOVE	
EXIT TO CANCEL	

Note: The names in the "From" and "To" boxes are not the waypoint numbers - they are the waypoint names.

Press the EXIT key to erase this menu.

Delete a Waypoint

To erase all of the information in a user waypoint, first press the WPT key, then select the waypoint you want to erase. Now highlight the "DELETE WPT" label and press the right arrow key. A message appears, asking if you really want to delete this waypoint. Press the right arrow key to delete it, the left to exit without deleting the waypoint.

Delete All Waypoints

You can remove all of the waypoints from the unit's memory. To do this, press the MENU key, then highlight the "SYSTEM SETUP" menu and press the right arrow key. Now highlight the DEL ALL WPTS label. The unit removes all waypoints from memory. Note: This also removes all routes from memory.

“NEAREST” FEATURE

The AirMap 300 can show a list of the nearest airports, VORs, NDBs, intersections, or user waypoints to your present position.

To use this feature, simply press the Z-OUT and Z-IN keys *at the same time*. The screen shown at right appears. The nearest airports show first. The airport’s range and bearing that’s closest to your present position shows at the top of this list. The other airports are shown on the list in increasing order from your present position. To view airports not shown, press the down arrow key to the bottom of the list and hold it. The list scrolls upward until the last airport appears.

AIRPORT	
1H6	1.15 118°
TUL	3.61 319°
OK16	7.64 18°
5F2	8.77 290°
RUS	9.45 221°
K11	10.28 62°
OK6	12.90 1°
2F6	14.84 322°
OF8	14.95 271°

To view information about any of these airports, highlight the desired airport, then press the right arrow key. For the screen shown at right, we highlighted the “1H6” airport, then pressed the right arrow key. You’ll recognize this as the airport database screen. You can view any information about this airport using the arrow and EXIT keys. If you wish to navigate to this airport, simply highlight the “GO TO AIRPORT” label, then press the right arrow key. Press the EXIT key to return to the nearest waypoint list.

AIRPORT	
ID-1H6	
GO TO AIRPORT	
NAME-YOUNG	
CITY-TULSA, O K	
COMM FREQ	
RUNWAYS	
SERVICES	
ELEV-750	
N 36° 08.339'	
W 95° 49.499'	
DIS-1.15NM	
BRG-118° MAG	

To see the other lists, move the black box to the “AIRPORT” label at the top of the screen, then press the left or right arrow keys. This rotates the “nearest” feature to the other lists. All of these work identically to the airports list. You can view all data or navigate to any item on any list.

Press the EXIT to return to the navigation, mapping, or windows screen.

Waypoint Options

You can customize the method used to show a user waypoint on the map screens. To do this, first press the MENU key, then select "MAP SETUP", finally select "WAYPOINT OPTIONS". The screen shown at right appears. You can turn all of the waypoints, their symbols, names, or numbers on or off. Simply select the desired label, then press the appropriate arrow key. Press the EXIT key to erase this menu.

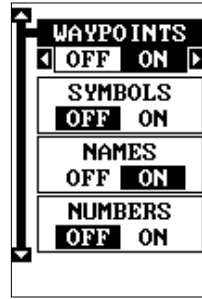

ROUTES

You can connect several waypoints (user or aviation) together to form a route. When you recall the route, the unit shows navigation information to the first waypoint in the route, then when you reach that waypoint, it switches to the next waypoint, and so on until you reach the last waypoint in the route.

Create a Route

To create a route, first press the MENU key, highlight the "ROUTE PLANNING" label, and press the right arrow key. The screen shown at right appears.

This unit can store up to 99 routes. Route number one shows on this page. If you wish to create a route using a different number, simply press the left or right arrow keys until the desired route number appears. In this example, however, we'll use route number one.

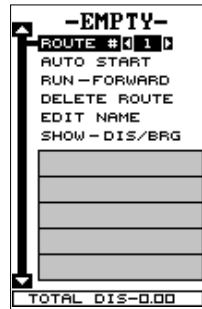

If you wish to name the route, highlight the "EDIT NAME" label and press the right arrow key. Use the arrow keys to name the route, (you can use up to eight characters in the name) then press the ENT key when you're finished.

The gray boxes in the lower half of the screen comprise the list of waypoints that form the route. To add waypoints to the route, highlight the first gray box in the middle of the screen and press the right arrow key. The screen shown at right appears. To add a waypoint to the route from the waypoint table, select the "ADD WPT" label. The screen shown at the left on the next page appears.

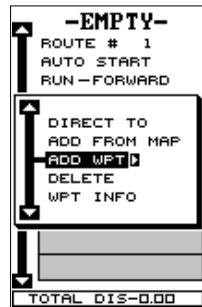

Add From Waypoint List

This screen is virtually identical to the database screen. Select a user waypoint, airport, VOR, NDB, or intersection. You can select a user waypoint either by using the waypoint number, waypoint name, or from the waypoint list. After selecting the waypoint, highlight the "ADD TO ROUTE" label and press the right arrow key. The unit returns to the route screen with the first waypoint at the top of the list. Highlight the next waypoint location beneath the first waypoint and press the right arrow key. Now repeat the previous steps to select the second waypoint for your route. After selecting the second waypoint, the unit returns to the waypoint list screen. The second waypoint shows beneath the first one, with bearing and distance from the first waypoint in the route to the second showing under the second waypoint's name.

```

AIRPORT
ID-DUC
ADD TO ROUTE
NAME-HALLIBURTON
CITY-DUNCAN, OK
COMM FREQ
RUNWAYS
SERVICES
ELEV-1113
N 34° 28.252'
W 97° 51.581'
DIS-138.8NM
BRG-205° MAG
    
```

SELECT FIRST
WAYPOINT AND ADD
TO ROUTE

```

ROUTE # 1
AUTO START
RUN-FORWARD
DELETE ROUTE
EDIT NAME
SHOW-DIS/BRG
1 DUC APT
TOTAL DIS-0.00
    
```

UNIT RETURNS TO
ROUTE PAGE

```

ROUTE # 1
AUTO START
RUN-FORWARD
DELETE ROUTE
EDIT NAME
SHOW-DIS/BRG
1 DUC APT
2 FSM APT
  184.2/67°
TOTAL DIS-184.2
    
```

REPEAT UNTIL
ALL WAYPOINTS
ARE IN ROUTE

Add From Map

You can add waypoints from the map, even create new ones. To do this, select "ADD FROM MAP" from the menu as shown below left. A screen similar to the one below center appears. Using the arrow keys, move the cursor to the desired waypoint or location. Now press the ENT key to add it to the route. If it's an existing waypoint, it will be added to the route. If you

```

ROUTE # 1
AUTO START
RUN-FORWARD
DIRECT TO
ADD FROM MAP
ADD WPT
DELETE
WPT INFO
TOTAL DIS-184.2
    
```

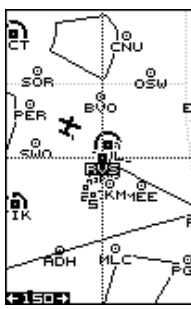

```

ROUTE # 1
AUTO START
RUN-FORWARD
DELETE ROUTE
EDIT NAME
SHOW-DIS/BRG
1 DUC APT
2 184.2/67°
3 RVS APT
  89.39/293°
TOTAL DIS-273.6
    
```

mark a location with the cursor that isn't a waypoint, the unit will create a waypoint and add it to the route. To add another location or waypoint to the route, move the cursor to that location and press the ENT key. When you're finished, press the EXIT key. The screen at right appears.

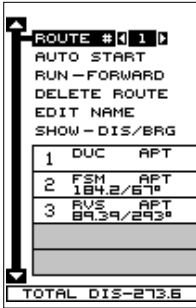

The total route distance shows at the bottom of the screen. Continue selecting waypoints until all of the waypoints in the route are on the list. Your route is now saved in memory. Press the EXIT key to erase the menus.

Delete a Waypoint

To remove a waypoint from a route, first select the route, then select the waypoint that you want to delete and press the right arrow key. Highlight the "Delete" label on this menu and press the right arrow key. The unit returns to the route list with the waypoint removed from the list. (Note: This doesn't delete the waypoint from the database, it simply removes it from the route.)

Waypoint Statistics

By default, this unit shows the distance and bearing from each waypoint in the route to the next. It will also show estimated time en route (ETE), estimated time of arrival (ETA), or the waypoint names (NAMES). To view the different statistics, highlight the "SHOW-DIS/BRG" label, then press the left or right arrow key until the desired statistic appears.

Following a Route - Direct To Method

Before starting the route, you'll need to decide if you want to start at the first waypoint and travel forward to the last waypoint or start at the last waypoint in the route and travel backwards (reverse) to the first waypoint. The default is forward. You can also start at the closest waypoint to your position, then travel forward or reverse through the route using the "AUTO START" feature.

To follow a route, first select the route number that you wish to follow by highlighting the "Route #" label, and pressing the left or right arrow keys until the desired route number appears. In this example we're using route number one (shown at right). To run the route from the last waypoint to the first, highlight the "RUN" label and press the right arrow key to change it from forward to reverse.

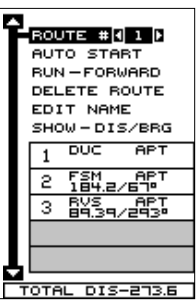

Now highlight the first waypoint in the route that you wish to start with and press the right arrow key. (The first waypoint in the route is used in this example.) The screen shown at right appears. Now select “DIRECT TO” and press the right arrow key.

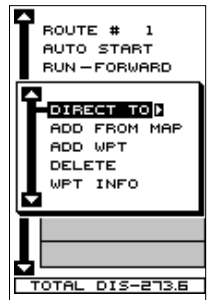

The unit returns to the last used navigation, mapping, or windows screen. In this example, map screen 1 was in use. A box with the “S” inside represents your location when you started the route. A dotted line shows from your starting position to the waypoint. A dashed line extends from this waypoint to each of the other waypoints in the route. Follow these lines to get to each of the waypoints. When you enter the radius set by the arrival alarm, the unit automatically switches to the next waypoint on the list, showing navigation data to that waypoint, and so on until the last waypoint on the route list has been reached. (Note: The arrival alarm does not have to be turned on.) The unit continues to show navigation data to the last waypoint in the route until you end the navigation. (See “Cancel Navigation”)

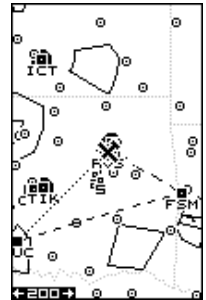

Following a Route - Auto Start Method

You don't have to choose the starting waypoint in a route. Selecting “AUTO START” on the route planning menu, starts navigation along the *leg* of the route that is closest to your present position. For example, imagine a route with four waypoints, numbered 1 thru 4. When the route was started, the first leg of the route (from waypoint #1 to waypoint #2) was the closest to the present position. Therefore, the unit shows navigation information to waypoint number 2. The first leg of the route, from #1 to #2 is shown on the screen by a dotted line. Once you arrive at waypoint number 2, the unit switches to the next waypoint in the route, and so on. The rest of the route navigation is used normally.

Waypoint Information

To see details about the highlighted waypoint, select the waypoint from the list of waypoints on the route screen, then press the right arrow key. The screen at right appears. Now select “WPT INFO”. The screen at the top of the next page appears.



The selected waypoint number appears at the top of this screen. In this example, Jones airport (Riverside) in Tulsa was selected. Information about the waypoint shows at the bottom of the screen. When you're finished with this screen, press the EXIT key to erase it.



Delete a Route

To erase a route, highlight the "ROUTE #" label on the route planning menu, then select the route you want to erase. Next, highlight the "DELETE ROUTE" label and press the right arrow key. A message appears, asking if you really want to erase the route. If you press the right arrow key, the route will be erased. If you select "Yes" (by pressing the right arrow key) the unit then asks if you want to erase the waypoints used in the route from memory also. Press the right arrow key again to erase them, or the left arrow key to leave the waypoints in memory. The unit returns to the routes menu. Press the EXIT key to erase the menu.

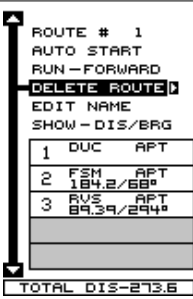

CANCEL NAVIGATION

This unit continues to navigate to a recalled waypoint, the last waypoint in a route, or the cursor position until you stop it.

To stop the navigation function, press the MENU key, then press the up or down arrow keys until the "Cancel Nav" label is highlighted. Press the right arrow key. The unit stops showing navigation information.

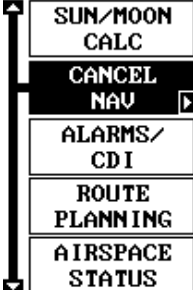

Navigation Notes

If you are navigating with this unit, either to a waypoint or in a route and shut it off, it will preserve the current waypoint number that it is navigating to. It also saves the current route (if it is in use) and the route's forward or reverse order. When you turn the unit on, it will show navigation data to the waypoint as soon as it locks onto the satellites as if it had never been turned off.

SYSTEM SETUP

Many features are listed under the “System Setup” label on the main menu. These commands affect the basic operation of the unit. To use them, press the MENU key, then “System Setup”. The screen at right appears.

Audio/Screen

To turn the speaker off or on, adjust the contrast and backlight, select “AUDIO/SCREEN” from the System Setup menu. The screen shown below appears.



Sound

To turn the speaker off, highlight the “SOUND” label as shown at right, then press the left arrow key. Note: This turns the speaker completely off. The unit will not sound a tone when a key is pressed, nor will any alarm sound. The alarm messages will still flash on the screen, however.

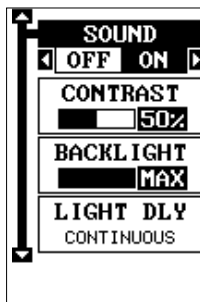

Contrast

To adjust the display’s contrast, highlight the “Contrast” label. Press the right or left arrow keys until the screen’s contrast is best for the lighting conditions.

Backlight

The display has lights that can be turned on for night use. To turn the lights on, simply press the PWR key. To turn them off, press the PWR key again. A light bulb indicator on the satellite status screen shows when the lights are on.

The default light level is maximum. To reduce the level, select “BACK-LIGHT”, then press the left arrow key until the lights are at the desired level. To increase the light level, press the right arrow key.

The lights automatically turn off after 30 seconds to preserve the battery power. It will do this even if the external power is applied to the unit. The time delay is adjustable from 5 to 240 seconds by selecting Light Dly from the System Setup menu . You can also turn the lights on continuously from this menu. Highlight this menu, then press the right arrow key to increase the time the lights are on, the left arrow key to decrease it.

Set Local Time

When this unit is first initialized, it may not show the correct time for your location due to daylight savings time, time zone variances, and so on. If the time shown on the clock displays is incorrect, select "SET LOCAL TIME" from the system setup menu and press the right arrow key. The screen shown at right appears.

Use the left or right arrow keys to select the number in the current time that you want to change. Use the up or down arrow keys to change the number. Press the ENT key to save the change, the EXIT key to erase the menu without changing it.

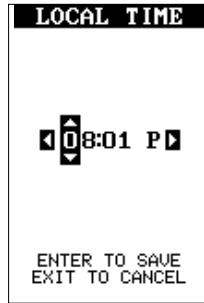

Units of Measure

You can view data in three different formats: statute, nautical, and metric. The default is nautical. The chart below shows the settings for each.

	Statute	Nautical	Metric
Distance	miles	nautical miles ...	kilometers
Speed	miles per hour	knots	kilometers per hour
Altitude	feet	feet	meters

The unit will also show bearing in degrees true or magnetic, and the clock in 12 hour (a.m./p.m.) or 24 hour formats. To change a unit of measure, first select "CHANGE UNITS" from the System Setup menu. Highlight the desired selection, then press the left or right arrow key. You can change any or all of the settings on this page. When you're finished, press the EXIT key.

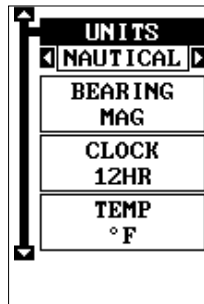

NMEA / DGPS

This product transmits data through the power/data port in the back of the unit using NMEA 0183 format, version 1.5 or 2.0. The data is used by other electronic devices such as marine autopilots for position and steering information.

DGPS on the other hand, is a data input. DGPS is an acronym for Differential Global Positioning System. Currently, it relies on a system of ground-based transmitters that send correction signals to small DGPS receivers. DGPS gives you more accurate positions than is otherwise possible.

All wiring connections to this GPS receiver are made through the power

cable. See the sample wiring diagrams on the next page for general wiring procedures. Read your other product's owner's manual for more wiring information.

Once the cables are wired, turn the unit on, press the menu key, and select "NMEA / DGPS CONFIG" from the System Setup menu. A screen similar to the one shown below appears.

NMEA Output

To turn the NMEA output on, highlight the "NMEA OUT" menu (shown at right), then press the right arrow key. If your other equipment works, then no setup will need to be performed. If your other equipment doesn't recognize the NMEA data being sent by the AirMap 100 and the wiring is correct, then you may need to change the NMEA or the serial communication settings.

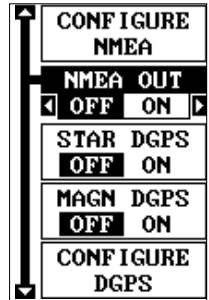

Configure NMEA Output

Highlight the "Configure NMEA" menu, then press the right arrow key. The screen shown below appears.

NMEA 0183 Version

There are two versions of the NMEA data, 1.5 and 2.0. If your other equipment requires 1.5, press the left arrow key to select it.

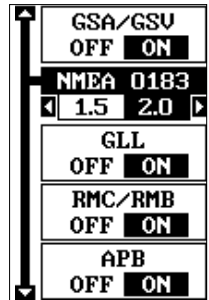

GLL, RMC/RMB, APB, GGA, GSA/GSV

Sentences

Some equipment requires different sentences. The default setting for these sentences is on. In other words, it automatically sends these sentences when NMEA is turned on. To turn any of these off, move the black box to the desired menu and press the left arrow key. Press the EXIT key when everything on this screen is the way you want it.

DGPS

This unit will recognize Starlink® and Magnavox® automatic DGPS receivers. If you have either one of these receivers, simply highlight the "Star DGPS" or "Magn DGPS" on the NMEA / DGPS menu (shown at the top of this page) and press the right arrow key to turn it on. (Note: If you have a Magnavox DGPS receiver connected, the AirMap 100 can't send NMEA data.) With the exception of serial communications, typically no other setup needs to be made with these receivers.

TO AIRMAP 100

AIRMAP 100 TRANSMITTING NMEA DATA TO ANOTHER DEVICE

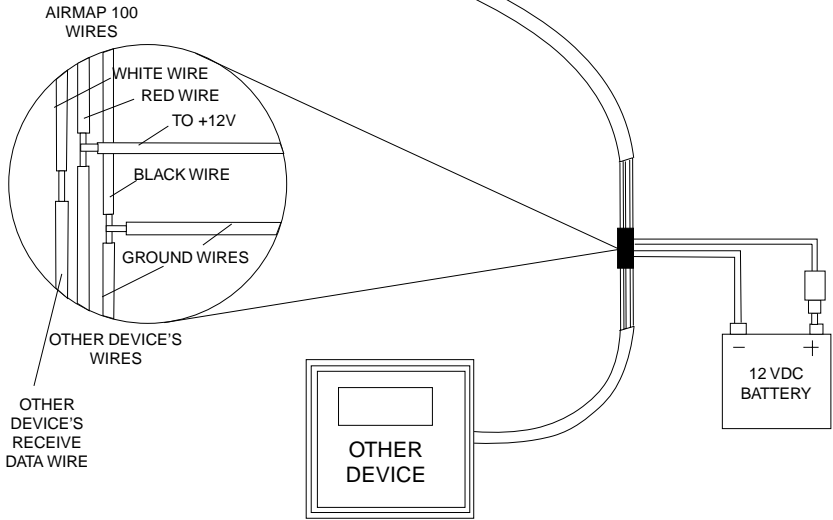

TO AIRMAP 100

AIRMAP 100 RECEIVING DATA FROM A DGPS RECEIVER

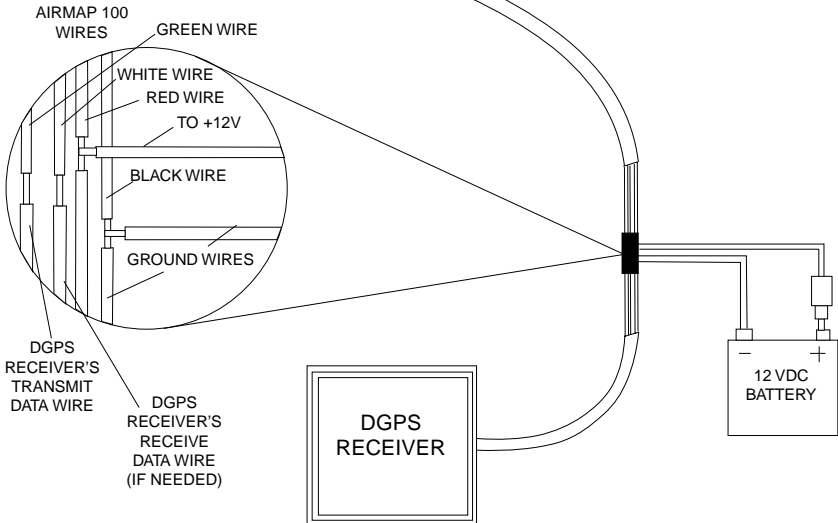

If you have any other Magnavox or Starlink compatible DGPS receiver connected to the AirMap 100, you may need to change the settings. To do this, move the black box to the “Configure DGPS” label and press the right arrow key. A screen similar to the one at right appears.

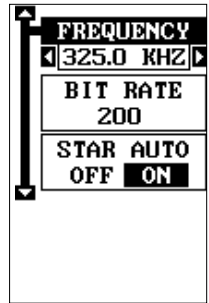

These menus select the beacon receiver's frequency and bit rate (in bits per second). To change one of these settings, simply highlight the menu item you wish to change, then press the right or left arrow key until the desired number appears.

The “STAR AUTO” menu works with the Starlink or compatible receivers that automatically determine the frequency and bit rate. If you have one of these receivers, leave this set to “ON”.

Press the EXIT key when you're finished.

Serial Communication Setup

If you're connecting a computer or other serial device to this unit, (including DGPS receivers) you'll probably need to change the communications settings. To do this, select “COM PORT SETUP” on the System Setup menu. Press the right arrow key. The screen shown at right appears.

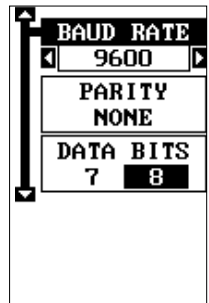

Check your computer or DGPS receiver's manual for the proper data settings. Highlight the menu item you need to change. Press the left or right arrow keys to change them. The serial port defaults are 4800 baud, no parity, and 8 data bits. Press the EXIT key to erase this menu.

Reset Options

To return the unit to the original factory settings, highlight the “RESET OPTIONS” menu on the System Setup screen. Now press the right arrow key. A message appears, asking if you want to restore the original options. Press the right arrow key if you do, the left arrow key to quit.

If you restore the unit to the factory settings, all options such as contrast, alarms, and other system choices are returned to their default values. However, no waypoints, routes, or icons are erased.

Reset Groups

To return all window groups and boxes on the navigation and mapping screens to their factory defaults, select "RESET GROUPS" on the System Setup menu. Finally, press the right arrow key. All window groups and digital boxes are reset to their factory settings.

System Info

The system information screen shows the release date and the software's version number. To view this screen, highlight "SYSTEM INFO" on the System Setup menu. Now press the right arrow key. Press the EXIT key when you're finished reading this screen.

GPS SETUP

Items found under the GPS Setup menu include initialization, (covered at the beginning of this manual), position format, power save, datums, and more. To use any of these features, first press the MENU key, highlight GPS Setup and press the right arrow key. The screen shown at right appears.

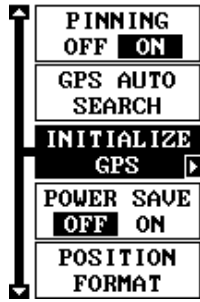

POWER SAVE

This GPS receiver has an important power save feature that significantly improves battery life. However, this feature does affect the receiver's performance. If you are using it under heavy cover, such as trees or around tall buildings, the receiver can lose its lock on the satellites easier when the power save feature is enabled. The power save feature changes the position update rate. We recommend you test the power save feature in known surroundings and determine its capabilities before venturing into unknown territory.

To turn the power save feature on, select "PWR SAVE" from the GPS SETUP menu and press the right arrow key to turn it on. Press the EXIT key to erase the menu.

The letters "PS" for "Power Save" show on the satellite status screen whenever the power save mode is on. You can also verify the power save mode status by viewing the GPS Setup menu.

To turn the power save mode off, simply return to the GPS Setup menu as described above, highlight the "PWR SAVE" label, and press the left arrow key.

Position Format

The AirMap 100 can show the position in degrees, minutes, and thousandths of a minute (36° 28.700') or degrees, minutes, seconds, and tenths of a second (36° 28' 40.9"). It can also show position in UTM (Universal Transverse Mercator) projection, British, Irish, Swedish, Swiss, Finnish, New Zealand, German, Taiwan, and Military Grid.

UTM's are marked on USGS topographic charts. This system divides the Earth into 60 zones, each 6 degrees wide in longitude.

German, Taiwan, British, Irish, Swedish, Swiss, New Zealand, and Finnish grid systems are the national coordinate system used only in their respective countries. In order to use these grid systems, you must be in the respective country. This unit will pick the matching datum for you when you select the grid. See the Datums section for more information.

The military grid reference system (MGRS) uses two grid lettering schemes, which are referred to as standard and alternate MGRS on the AirMap 100. Your position and datum in use determines which one to use. If you use the standard, and your position is off significantly, then try using the alternate.

Note: When the position format is changed, it affects the way all positions are shown on all screens. This includes waypoints.

To change the format, highlight the "Position Format" label on the "GPS Setup" menu, then press the right arrow key. A screen similar to the one at right appears. Press the up or down arrow keys to select the desired format. Press the EXIT key to erase the position format menu.

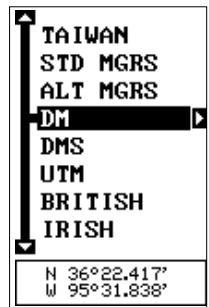

DATUM

Maps and charts are based on a survey of the area that's covered by the map or chart. These surveys are called "Datums". Maps that are created using different datums will show the same latitude/longitude in slightly different locations.

All datums are named. The GPS system is based on the WGS-84 datum, which covers the entire world. Other datums may also cover the entire world, or just a small portion. By default, your position shows using the WGS-84 datum. However, it can show your position using one of 191 different datums.

To change the datum, first press the MENU key, then highlight the “GPS Setup” label and press the right arrow key. Now highlight the “Select Datum” label. Finally, press the right arrow key again. A screen similar to the one at right appears.



The WGS-84 label is highlighted. To change it, simply press the up or down arrow keys to highlight the desired datum, then press the ENT key. This selects the datum and erases the select datum menu. To erase the menu without changing the datum, simply press the EXIT key.

A list of the datums used by the AirMap 100 is in the back of this manual.

PCF (Position Correction Factor)

Another method used to make your display match a chart or map is called “PCF” or Position Correction Factor. This unit gives you the capability to move or offset the position shown on the display to match one on the chart. The unit will add this offset to all position and navigation displays at all times.

Remember, the position error on any radio navigation system is very dynamic and the PCF offset should never be used in an attempt to cancel the error.

In general terms, PCF should only be used if your map indicates what the possible error is. **PCF should always be reset to zero when you're finished with the chart.**

For example, suppose you are stopped at a location that is accurately marked on a chart. Your unit shows a longitude position that is .244 minutes east of the one on the chart and .047 minutes north latitude. Using the PCF feature, you can make the AirMap 100 match the chart you're using. If you move, the unit will continuously add the change to all position, navigation, and mapping displays. This makes it more closely match the datum used by the chart. For this reason, you should be careful when entering the PCF offset. It's saved in memory and doesn't change when the unit is turned off. However, resetting the unit does erase the PCF offset.

To change the PCF offset, first press the MENU key, then highlight the “GPS Setup” label and press the right arrow key. Now highlight the “Set PCF Offset” label. Finally, press the right arrow key again.

A screen similar to the one at right appears.

Now enter the correction for your location. Remember, this is the difference between the location shown on the present position display and the position shown on the chart. In this example, we entered 0 degrees, 0.047 minutes north latitude and 0 degrees, 0.244 minutes east longitude. That is the difference between the present position shown by the AirMap 100 and the one on our chart.

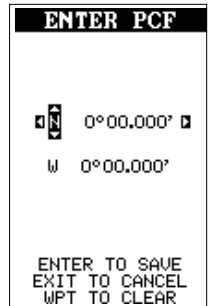

After you've entered the latitude/longitude correction, press the ENT key to accept it. The AirMap 100 erases the PCF entry screen and returns to the navigation or mapping screens with the correction factor applied.

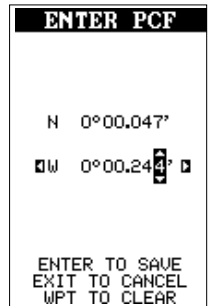

POSITION PINNING

When using a GPS receiver at extremely low speeds, it can have trouble determining your course over ground, or direction you're travelling. This is due in large part to SA, or selective availability. SA is small inaccuracies purposefully put into the GPS satellite's signal by the government. This causes wide variations in the track display and other navigation displays when using the unit at slow speeds.

If you're using this receiver without DGPS and stop, the position pinning feature locks the present position indicator on the plotter until you've moved a short distance or exceed a very slow speed. This prevents the "wandering" plot trail seen when you're stopped with position pinning turned off. This also affects the navigational displays.

The easiest way to see the effects of SA is to stand still with the GPS receiver turned on and watch your plot trail with position pinning turned off. You'll see the present position change, speed increase and decrease, and a random plot trail on the plotter's screen.

If you wish to turn the position pinning feature off, press the MENU key, then highlight the "GPS Setup" label and press the right arrow key. Now highlight the "Pinning" label. Finally, press the left arrow key.

ALARMS

This GPS receiver has several alarms. You can set an arrival alarm to sound a warning tone when you cross a preset distance from a waypoint. For example, if you have the arrival alarm set to .1 mile, then the alarm will sound when you come within .1 mile of the recalled waypoint. The course deviation indicator alarm (CDI) can sound a warning when your track drifts too far to the right or left of the line to the waypoint. For example, if the alarm is set to .1 mile, then the alarm will sound if you drift .1 of a mile or more to the right or left of the line to the waypoint. The anchor alarm sounds a warning when you drift outside of a preset radius. Again, using the .1 mile as an example, if you're anchored and your seaplane or floatplane moves more than .1 of a mile, the alarm will sound.

To use any of these alarms, first press the MENU key, then select the "ALARMS/CDI" menu. A screen similar to the one shown at right appears. Press the up or down arrow key to highlight the desired alarm, then press the right arrow key to turn it on.



To adjust an alarm's distance, highlight the alarm's "DIS" menu item, then press the right or left arrow keys to increase or decrease the alarm's distance.

The DGPS message appears when the unit begins or stops using DGPS data to help determine your position.

The default setting for this messages is "on". To turn the message off, select "DGPS MSG" and press the left arrow key.

Press the EXIT key to erase the alarms menu when you're finished.

Important!

Anchor Alarm - Since civilian users don't receive the accuracy given to military users, the anchor alarm may sound even when you're sitting still. This typically happens when using small (less than .05 mile) anchor alarm ranges. If you have a DGPS beacon receiver connected to this unit, smaller ranges may be usable.

AIRSPACE ALARMS

This unit has two airspace alarms that are triggered by any airspace that it's capable of showing. The first alarm is a "look-ahead" alarm that (based on your current speed and track) sounds an alarm ten minutes before you reach an airspace.

The second alarm, "Distance warning" sounds when you are within 2 nautical miles of an airspace in any direction.

The limits on both the "look ahead" and the "distance warning" alarm are adjustable. To do this, first select the alarms menu from the main menu. Next, highlight "AIRSPACE ALARMS" and press the right arrow key. The screen shown at right appears.



To adjust an alarm, or turn it on or off, highlight the desired label, then press the right or left arrow keys. When you have everything on this page set as desired, press the EXIT key to erase this menu and return to the ALARMS menu.

When an alarm is triggered, the AirMap 100 flashes a message on the screen as shown at right. To view the airspace information, switch to the "Messages" mode.

Airspace alarms work in the 3D mode. In other words, not only does your position and track determine when an airspace alarm is triggered, but also your altitude (as displayed on the AirMap 100), plus or minus 1000 feet. For example, if the ceiling of an airspace that you are heading for is 4000 feet and the AirMap 100 is showing 4500 feet, the airspace alarm will be triggered and a message will be shown on the display, as shown above. A message is also placed in the airspace status menu when the airspace alarm is triggered. To view the message, press the MENU key, then highlight the "AIRSPACE STATUS" label and press the right arrow key. A screen similar to the one at right appears, describing the airspace you are about to penetrate.



(Note: The distance and time alarms will still sound if triggered by either a restricted or prohibited airspace, even if they're turned off.)

SUNRISE/SET MOONRISE/SET CALCULATOR

This unit has a sunrise/sunset and moonrise/moonset calculator that shows this information anywhere or anytime in the world. To use it, press the MENU key, then highlight "SUN/MOON CALC" and press the right arrow key. Highlight either the sun or moon calculator and press the right arrow key. The screen shown at right appears if you chose the sunrise calculator. (Both calculators work identically. The sunrise/sunset calculator is used for this example.) The sunrise and sunset for today's date appear in the center of the screen. Today's date shows at the top of the screen. If you want to know the sunrise/sunset for a different date, press the ENT key, then enter the new date with the arrow keys. The unit returns to the sunrise/sunset calculator screen with the sunrise and sunset times shown for the date you entered.

The sunrise and sunset show for your present position. If you move the plotter's cursor to a different position before using this calculator, it will show the sunrise/sunset for the cursor's location.

The moonrise/moonset calculator works identically to the sunrise/sunset calculator. It looks like the screen at right. A moon symbol shows near the bottom of the screen, showing the approximate phase of the moon. The arrow next to the symbol shows if it is moving towards a full moon (up) or a new moon (down).

Press the EXIT key to erase this screen.

SIMULATOR

A simulator is built into this unit that has several options. You can use nearly all of the unit's features - even save and recall waypoints. This is useful for trip planning.

To use the simulator, press the MENU key, then highlight "SIMULATOR SETUP" . Now press the right arrow key. The screen shown at right appears.

If you simply press the right arrow key, turning the simulator on, the AirMap 100 will start from your present position and follow a track of 355° at 100 miles per hour.

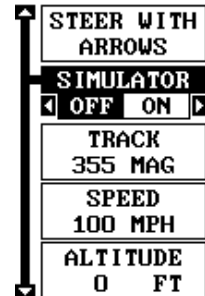
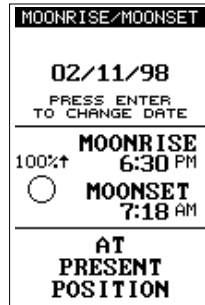
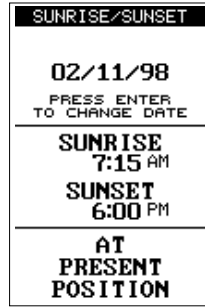

To change either the track or speed, highlight the one you want to change, then press the right or left arrow key. When the numbers are correct, press the EXIT key.

Starting Position

Normally, the starting position for the simulator is your present position. If you want to change the starting position, highlight the "SET START WPT" label on the Simulator Setup menu, then press the right arrow key. The screen shown at right appears.

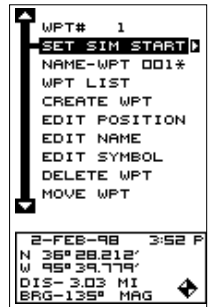

You can select any waypoint as the simulator's starting point. Select the starting point by pressing the right arrow key on the "WPT#" label until the desired starting waypoint number appears. Now highlight the "SET SIM START" label and press the right arrow key. The unit returns to the Simulator Setup menu using the specified waypoint as the starting waypoint.

Use Arrow Keys to Steer

This option lets you change both the course and speed on the screen as the simulator is running. To do this, highlight the "STEER WITH ARROWS" label on the Simulator Setup screen, then press the right arrow key. The screen shown at right appears. Use the up and down arrow keys to increase or decrease the speed. Use the right and left arrow keys to change the track. When you're finished changing the track and speed, press the EXIT key to erase the menus.

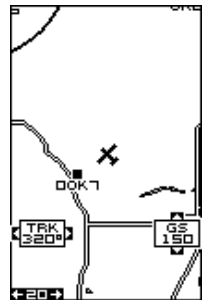

E6B COMPUTER

To help you with flight planning, this unit has a computer built into it that lets you calculate density altitude, true airspeed, wind speed and direction, plus vertical navigation.

To use this computer, first press the MENU key, then select "E6B COMPUTER" label. The screen shown at right appears. Highlight the desired mode and press the right arrow key.

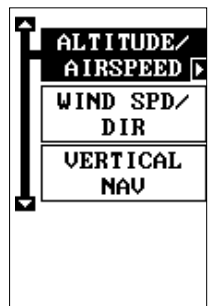

Density Altitude/True Airspeed

To calculate density altitude or true airspeed, highlight "ALTITUDE/AIRSPEED" from the screen at right and press the right arrow key. The screen at the top of the next page appears.

ALTITUDE/AIRSPEED	
I ALT	0 FT
BARO	29.92" Hg
I TEMP	0°F
CAS	0.0 KN
PRESSURE ALT	
	0 FT
DENSITY ALT	
	-4186 FT
TRUE AIR SPEED	
	0.0 KN

ALTITUDE/AIRSPEED	
I ALT	5000 FT
BARO	30.02" Hg
I TEMP	59°F
CAS	129.0 KN
PRESSURE ALT	
	4908 FT
DENSITY ALT	
	5740 FT
TRUE AIR SPEED	
	140.4 KN

WIND SPEED/DIR	
HEADING	321° MAG
TAS	140.4 KN
GS	0.0 KN
TRACK	320° MAG

WIND SPEED	
	10.7 KN
WIND FROM DIR	
	333° MAG
HEAD WIND	
	10.4 KN

WIND SPEED/DIR	
HEADING	333° MAG
TAS	140.4 KN
GS	130.0 KN
TRACK	320° MAG

WIND SPEED	
	10.4 KN
WIND FROM DIR	
	333° MAG
HEAD WIND	
	10.4 KN

simply highlight each item on the list at right, press the right arrow key, enter the values, and finally press the ENT key. You'll need the indicated altitude "I ALT", barometric pressure (BARO) in inches of mercury, outside air temperature (I TEMP), and calibrated airspeed (CAS).

On the example shown at right, the indicated altitude is 5000 feet, barometric pressure is 30.02", outside air temperature is 59° Fahrenheit, and the calibrated airspeed is 129 knots. This gives us a pressure altitude of 4908 feet, a density altitude of 5740 feet, and a true airspeed of 140.4 knots. Obviously, you don't need airspeed to calculate density altitude, this was done for illustration purposes.

Wind Speed/Direction

To determine the wind speed and direction, first solve for true airspeed on the previous screen. Then, select "WIND SPD/DIR" on the E6B Computer menu. A screen similar to the one at right appears. With true airspeed solved, the only other thing necessary for the unit to determine the wind is your heading. In this example, the heading is 321° magnetic. This gives us a wind speed of 10.7 knots on a bearing of 333° magnetic, for a 10.4 knot headwind.

Vertical Navigation

The AirMap 100 can help you decide when to let down for an approach to an airport. To use this feature, first press the MENU key, then highlight the “E6B Computer” label. Now highlight the “Vertical Navigation” label as shown at right and press the right arrow key. A screen similar to the one at right appears. It’s inactive at this time.

VERTICAL NAV	
V NAV	OFF ON
RATE	0FPM
FROM	0FT
TO	0FT
BY	0.0NM
POS	BEFORE
WPT	ICT

INACTIVE

We are travelling to the Wichita Mid-Continent airport in Wichita, Kansas. Its identifier is shown at the bottom of the screen - ICT. We are travelling at 4500 feet, and need to be at the pattern altitude (about 2300 feet) by 5 nautical miles from the airport using a 450 fpm descent.

After determining the above data, highlight each item on this screen and enter the data. When you’re finished, highlight the “Vertical Nav” label at the top of the screen and press the right arrow key. A screen similar to the one below appears.

VERTICAL NAV	
V NAV	OFF ON
RATE	450FPM
FROM	4500FT
TO	2300FT
BY	5.0NM
POS	BEFORE
WPT	ICT

INACTIVE

The solution to our vertical navigation problem shows at the bottom of the screen. Our current altitude is 4500 feet and at our current airspeed, we should begin our descent in 41 minutes and 8 seconds. If we maintain a 450 fpm descent in about 48 minutes, then we should reach pattern altitude 5 nautical miles before we reach the airport.

VERTICAL NAV	
V NAV	OFF ON
RATE	450FPM
FROM	4500FT
TO	2300FT
BY	5.0NM
POS	BEFORE
WPT	ICT
ELEVATION 4500FT	
BEGIN IN 0:41:08	

Jeppesen® Aviation Data Downloading Instructions

The aviation data in your AirMap 100 is held in “flash” memory. This means it can be re-programmed at any time. You can order updates at any time. Contact LEI Extras, Inc. at 1-800-324-0045 for database update pricing and information. A diskette with the Jeppesen aviation data is supplied with your unit along with a cable to connect the unit to an PC-compatible personal computer. The data on the diskette was the most recent at the time your unit was built at the factory. It may be more recent than the database in the unit’s memory. To determine if the data in the unit is older than the diskette’s, turn the unit on and look at the disclaimer screen, shown at right. The Jeppesen data’s expiration date shows near the bottom of this screen. Compare this date with the one on the diskette’s label. If it’s older than the diskette, you may want to update your unit.

DO NOT RELY ON
THIS PRODUCT AS
YOUR PRIMARY
SOURCE OF
NAVIGATION
THE OPERATOR IS
RESPONSIBLE FOR
USING OFFICIAL
GOVERNMENT
CHARTS AND
PRUDENT METHODS
FOR SAFE
NAVIGATION
JEPPESEN AMER/TWR
EXPIRES 3-DEC-97
PRESS EXIT

To update the aviation database, first connect the cable supplied with your unit to a serial port on the computer. Next, connect the other end to the AirMap 100. Turn the computer and the unit on, and place the diskette in the computer.

IMPORTANT!

The data on this diskette has a copy-protection feature. Do not attempt to copy the data or it could be damaged. Also, do not download this data to any GPS receiver other than the one you own. The software will only allow the data to be downloaded to one AirMap unit. You can download the data multiple times to one unit.

AirMap 100 Setup

The serial port is the only setup the AirMap needs. Press the MENU key. Now (using the up or down arrow key) highlight the “SYSTEM SETUP” label and press the right arrow key. Highlight the “COM PORT SETUP” label and press the right arrow key. The screen shown at right appears. The baud rate is highlighted at the top of the screen. Use the right arrow key to change the baud rate. Try using the highest baud available. If you have a communications failure, try a slower rate. There is a lot of data to transfer, therefore the faster the baud rate, the shorter time it will take. The AirMap is now ready to transfer data.

BAUD RATE
9600
PARITY
NONE
DATA BITS
7 8

PC Setup

Windows 3.x

- Insert the diskette into the drive.
- Select File | Run from the Program Manager menu.
- Type in the letter of the floppy drive followed by “FIXFLOP” and press Enter.
- Select File | Run from the Program Manager menu.
- Type in the letter of the floppy drive followed by “JEPPESEN” and press Enter.

PC Setup

Windows 95

- Insert the diskette into the drive.
- Click the Start button and select “Run”.
- Type in the letter of the floppy drive followed by “JEPPESEN” and press Enter.

Using the PC Software

A new window (shown at right) should appear on your PC’s screen. Select the serial port that the cable from the AirMap is connected to on your PC. Now select the baud rate that you previously selected on the AirMap. Finally, click on the “Transfer” button. The PC will send the aviation data to the AirMap.



If you have problems, click on “Help” on the data transfer program.

The aviation data update service for your Lowrance Avionics portable GPS receiver consists of copyrighted data compilations owned by Jeppesen Sanderson, Inc., which have a limited, non-exclusive license to use as specifically set forth herein. You may not copy, distribute or use any portion of said copyrighted subject matter, except in connection with the ordinary and intended use of the GPS receiver.

NOTICE!
JEPPESEN DATABASE UPGRADE

The data inside your AirMap 100 is a combination of Lowrance Avionics and Jeppesen. Database updates are made based upon a computer diskette program. Unlike other manufacturers, you don't need to return your unit for the Jeppesen database upgrade. Under this program you will receive a new PC-compatible computer diskette.

Updates to the aviation database are available as follows:

1. A onetime no-charge update is available in the event that the database enclosed in the AirMap 100 or on the diskette at the time of purchase has expired. This update offer is valid during the first 30 days from original purchase and dated proof of purchase is required.
2. Additional updates are available under either of the following options:

“On-request” non-subscription onetime update US \$75.00
or
Annual subscription consisting of 13 updates US \$595.00
(once every 28 days)

For update service, please contact:

LEI Extras, Inc.
12000 E. Skelly Drive
Tulsa, OK USA 74128

U.S. residents can call 1-800-324-0045
International customers please call 918-438-8686
All customers can also fax: 918-234-1710

The aviation data update service for your Lowrance Avionics portable GPS receiver consists of copyrighted data compilations owned by Jeppesen Sanderson, Inc., which have a limited, non-exclusive license to use as specifically set forth herein. You may not copy, distribute or use any portion of said copyrighted subject matter, except in connection with the ordinary and intended use of the GPS receiver.

DATUMS

WGS 84	WGS 1984	ARC 1960	Arc 1960 - Mean for Kenya,
DEFAULT	Default	MEAN	Tanzania
ADINDAN	Adindan	ASCENSION	Ascension Island 1958 -
MEAN	Mean for Ethiopia, Sudan	ISLAND	Ascension Island
ADINDAN	Adindan	ASTRO BEACON ..	Astro Beacon E 1945 - Iwo Jima
BURKINA	Burkina Faso	E 1945	
FASO		IWO JIMA	
ADINDAN	Adindan	ASTRO DOS 714 ..	Astro DOS 71/4 - St Helena Island
CAMEROON	Cameroon	ST HELENA	
ADINDAN	Adindan	ISLAND	
ETHIOPIA	Ethiopia	ASTRO TERN	Astro Tern Island (FRIG) 1961 -
ADINDAN	Adindan	ISLAND	Tern Island
MALI	Mali	1961	
ADINDAN	Adindan	ASTRONOMICAL ..	Astronomical Station 1952 -
SENEGAL	Senegal	STATION '52	Marcus Island
ADINDAN	Adindan	MARCUS ISLE	
SUDAN	Sudan	AUSTRALIAN	Australian Geodetic 1966 -
AFGOOYE	Afgooye	GEODETC	Australia & Tasmania
SOMALIA	Somalia	1966	
AIN EL ABD	Ain el Abd 1970	AUSTRALIAN	Australian Geodetic 1984 -
1970	Bahrain	GEODETC	Australia & Tasmania
BAHRAIN		1984	
AIN EL ABD	Ain el Abd 1970	AYABELLE	Ayabelle Lighthouse - Djibouti
1970 SAUDI	Saudi Arabia	LIGHTHOUSE	
ARABIA		DJIBOUTI	
ANNA 1 ASTRO	Anna 1 Astro 1965	BELLEVUE	Bellevue (IGN) - Efate &
1965 COCOS	Cocos Islands	(IGN) EFATE	Erromango Islands
ISLANDS		ERRAOMANGO	
ANTIGUA	Antigua Island Astro 1943	BERMUDA	Bermuda 1957 - Bermuda
ISLAND	Antigua (Leeward Islands)	1957	
ASTRO 1943		BISSAU	Bissau - Guinea-Bissau
ARC 1950	Arc 1950	GUINEA	
MEAN	Mean for Botswana, Lesotho,	BOGOTA	Bogota Observatory - Colombia
	Malawi, Swaziland, Zaire, Zambia,	OBSERVATORY	
	Zimbabwe	COLOMBIA	
ARC 1950	Arc 1950 - Botswana	BUKIT RIMPAH	Bukit Rimpah - Indonesia (Bangka
BOTSWANA		INDONESIA	& Belitung Islands)
ARC 1950	Arc 1950 - Burundi	CAMP AREA	Camp Area Astro - Antarctica
BURUNDI		ASTRO	(McMurdo Camp Area)
ARC 1950	Arc 1950 - Lesotho	ANTARCTICA	
LESOTHO		CAMPO	Campo Inchauspe - Argentina
ARC 1950	Arc 1950 - Malawi	INCHAUSPE	
MALAWI		ARGENTINA	
ARC 1950	Arc 1950 - Swaziland	CANTON ASTRO ..	Canton Astro 1966 - Phoenix
SWAZILAND		'66 PHOENIX	Islands
ARC 1950	Arc 1950 - Zaire	ISLANDS	
ZAIRE		CAPE	Cape - South Africa
ARC 1950	Arc 1950 - Zambia	SOUTH	
ZAMBIA		AFRICA	
ARC 1950	Arc 1950 - Zimbabwe	CAPE	Cape Canaveral - Bahamas,
ZIMBABWE		CANAVERAL	Florida
		BAHAMAS FL	

CARTHAGE	Carthage - Tunisia	EUROPEAN	European 1950
TUNISIA		1950 ITALY	Italy (Sardinia)
		(SARDINIA)	
CH-1903	Switzerland	EUROPEAN	European 1950
CHATHAM	Chatham Island Astro 1971	1950 ITALY	(Sicily)
ISLAND ASTRO	New Zealand (Chatham Island)	(SICILY)	
NEW ZEALAND		EUROPEAN	European 1950
CHUA ASTRO	Chua Astro	1950	Malta
PARAGUAY	Paraguay	MALTA	
CORREGO	Corrego Alegre	EUROPEAN	European 1950
ALEGRE	Brazil	1950 SPAIN	Portugal, Spain
BRAZIL		PORTUGAL	
DABOLA	Dabola	EUROPEAN	European 1979
GUINEA	Guinea	1979	Mean for Austria, Finland,
		MEAN	Netherlands, Norway, Spain,
			Sweden, Switzerland
DJAKARTA	Djakarta (Batavia)	FORT THOMAS	Fort Thomas, 1955
(BATAVIA)	Indonesia (Sumatra)	1955 NEVIS	Nevis, St. Kitts
INDONESIA		ST. KITTS	(Leeward Islands)
DOS 1968	DOS 1968	GAN 1970	Gan 1970
NEW GEORGIA	New Georgia Islands	REPUBLIC OF	Republic of Maldives
ISLANDS	(Gizo Island)	MALDIVES	
EASTER	Easter Island 1967	GEODETIC	Geodeic Datum 1949
ISLAND	Easter Island	DATUM 1949	New Zealand
1967		NEW ZEALAND	
EUROPEAN	European 1950	GRACIOSA	Graciosa Base SW 1948
1950 MEAN	Mean for Austria, Belgium,	BASE SW	Azores (Faial, Graciosa, Pico,
WESTERN	Denmark, Finland, France,	1948 AZORES	Sao Jorge, Terceira)
	West Germany, Gibraltar, Greece,		
	Italy, Luxembourg, Netherlands,	GUAM	Guam 1963
	Norway, Portugal, Spain, Sweden,	1963	Guam
	Switzerland	GUNUNG	Gunung Segara
EUROPEAN	European 1950	SEGARA	Indonesia (Kalimantan)
1950 MEAN	Mean for Austria, Denmark,	INDONESIA	
CENTRAL	France, West Germany,		
	Netherlands, Switzerland	GUX 1 ASTRO	GUX 1 Astro
EUROPEAN	European 1950	GUADALCANAL	Guadalcanal Island
1950 MEAN	Mean for Iraq, Israel, Jordan,	ISLAND	
MIDDLE EAST	Lebanon, Kuwait,	HERAT NORTH	Herat North
	Saudi Arabia, Syria	AFGHANISTAN	Afghanistan
EUROPEAN	European 1950	HJORSEY	Hjorsey 1955
1950	Cyprus	1955	Iceland
CYPRUS		ICELAND	
EUROPEAN	European 1950	HONG KONG	Hong Kong 1963
1950	Egypt	1963	Hong Kong
EGYPT		HU-TZU-SHAN	Hu-Tzu-Shan
EUROPEAN	European 1950	TAIWAN	Taiwan
1950 GREAT	England, Channel Islands, Ireland,	INDIAN	Indian
BRITAIN	Scotland, Shetland Islands	BANGLADESH	Bangladesh
EUROPEAN '50	European 1950	INDIAN	Indian
FINLAND	Finland, Norway	INDIA NEPAL	India, Nepal
NORWAY		INDIAN 1954	Indian - 1954
EUROPEAN	European 1950	THAILAND	Thailand, Vietnam
1950	Greece	VIETNAM	
GREECE		INDIAN 1975	Indian - 1975
EUROPEAN	European 1950	THAILAND	Thailand
1950	Iran		
IRAN			

IRELANDIreland 1965
1965 Ireland

ISTS 061ISTS 061 Astro 1968
ASTRO 1968 South Georgia Islands
S GEORGIA

ISTS 073ISTS 073 Astro 1969
ASTRO 1969 Diego Garcia
DIEGO GARCIA

JOHNSTONJohnston Island 1961
ISLAND Johnston Island
1961

KANDAWALAKandawala
SRI LANKA Sri Lanka

KERGUELENKerguelen Island 1949
ISLAND Kerguelen Island
1949

KERTAU 1948Kertau 1948
W MALAYSIA West Malaysia & Singapore
SINGAPORE

KUSAIE ASTRO ...Kusaie Astro 1951
CAROLINE 1951 Caroline Islands
ISLANDS

L C 5 ASTROL.C. 5 Astro 1961
1961 CAYMAN Cayman Brac Island
BRAC ISLAND

LEIGONLeigon
GHANA Ghana

LIBERIALiberia 1964
1964 Liberia

LUZONLuzon
PHILIPPINES Philipines
(Excluding Mindanao)

LUZONLuzon
PHILIPPINES Philipines (Mindanao)
MINDANAO

MAHE ISLANDMahe 1971
1971 Mahe Island

MASSAWAMassawa
ETHIOPIA Ethiopia (Eritrea)
(ERITREA)

MERCHICHMerchich
MOROCCO Morocco

MIDWAY ASTRO ...Midway Astro 1961
1961 Midway Islands

MINNAMinna
CAMEROON Cameroon

MINNAMinna
NIGERIA Nigeria

MONTSERRATMontserrat Island Astro 1958
ISLAND Montserrat
ASTRO 1958 (Leeward Islands)

M'PORALOKOM'Poraloko
GABON Gabon

NAHRWANNahrwan
OMAN Oman (Masirah Island)

NAHRWANNahrwan
SAUDI ARABIA Saudi Arabia

NAHRWANNahrwan
UNITED ARAB United Arab Emirates
EMIRATES

NAPARIMA BWINaparima BWI
TRINIDAD AND Trinidad & Tobago
TOBAGO

N AMERICANorth American 1927
1927 MEAN Mean for Antigua, Barbados, Barbuda,
CARRIBEAN Caicos Islands, Cuba, Dominican
Republic, Grand Cayman, Jamaica,
Turks Islands

N AMERICANorth American 1927
1927 MEAN Mean for Belize, Costa Rica,
CENTRAL AMER El Salvador, Guatmla, Honduras,
Nicaragua

N AMERICANorth American 1927
1927 MEAN Mean for Canada
CANADA

N AMERICANorth American 1927
1927 MEAN Mean for CONUS
CONUS (Continental United States)

N AMERICANorth American 1927
1927 MEAN Mean for CONUS (East of Mississippi
CONUS EAST River) including Louisiana, Missouri,
Minnesota

N AMERICANorth American 1927
1927 MEAN Mean for CONUS
CONUS WEST (West of Mississippi River)

N AMERICANorth American 1927
1927 ALASKA Alaska

N AMERICANorth American 1927
1927 BAHAMAS Bahamas
(NO SAN SALV) (Except San Salvador Island)

N AMERICANorth American 1927
1927 BAHAMAS Bahamas (San Salvador Island)

N AMERICANNorth American 1927
1927 CANADA Canada (Alberta, British Columbia)
(WEST)

N AMERICANNorth American 1927
1927 CANADA Canada (Manitoba, Ontario)
(CENTRAL)

N AMERICANNorth American 1927
1927 CANADA Canada (New Brunswick,
EAST Newfoundland, Nova Scotia, Quebec)

N AMERICANNorth American 1927
1927 CANADA Canada (Northwest Territories,
NORTH Saskatchewan)

N AMERICANNorth American 1927
1927 CANADA Canada (Yukon)
YUKON

N AMERICAN	North American 1927	PITCAIRN	Pitcairn astro 1967
1927 CANAL	Canal Zone	ASTRO	Pitcairn Island
ZONE		1967	
N AMERICAN	North American 1927	POINT 58	Point 58
1927 CUBA	Cuba	BURKINA	Mean for Burkina Faso & Niger
N AMERICAN	North American 1927	FASO NIGER	
1927	Greenland (Hayes Peninsula)	POINTE NOIRE	Pointe Noire 1948
GREENLAND		1948 CONGO	Congo
N AMERICAN	North American 1927	PORTO SANTO	Porto Santo 1936
1927 MEXICO	Mexico	1936 MADEIRA	Porto Santo, Madeira Islands
		ISLANDS	
N AMERICAN	North American 1983	POTSDAM	Germany
1983 ALASKA	Alaska, Canada, CONUS	PROVISIONAL	Provisional S. American 1956
CANADA CONUS		S AMERICA	Mean for Bolivia, Chile, Colombia,
N AMERICAN	North American 1983	1956 MEAN	Ecuador, Guyana, Peru, Venezuela
1983 CENTRAL	Central America, Mexico	PROVISIONAL	Provisional S. American 1956
AM MEXICO		S AMERICA	Bolivia
OBSERVATORIA ...	Observaorio Metereo 1939	1956 BOLIVIA	
METEREO	Azores (Corvo & Flores Islands)	PROVISIONAL	Provisional S. American 1956
1939 AZORES		S AMERICA	Chile (Northern, Near 19°S)
OLD EGYPTIAN	Old Egyptian 1907	1956 N CHILE	
1907 EGYPT	Egypt	PROVISIONAL	Provisional S. American 1956
OLD HAWAIIAN	Old Hawaiian	S AMERICA	Chile (Southern, Near 43°S)
MEAN	Mean for Hawaii, Kauai,	1956 S CHILE	
	Maui, Oahu	PROV S AMER	Provisional S. American 1956
OLD HAWAIIAN	Old Hawaiian	1956	Colombia
HAWAII	Hawaii	COLOMBIA	
OLD HAWAIIAN	Old Hawaiian	PROVISIONAL	Provisional S. American 1956
KAUAI	Kauai	S AMERICA	Ecuador
OLD HAWAIIAN	Old Hawaiian	1956 ECUADOR	
MAUI	Maui	PROVISIONAL	Provisional S. American 1956
OLD HAWAIIAN	Old Hawaiian	S AMERICA	Guyana
OAHU	Oahu	1956 GUYANA	
OMAN	Oman	PROVISIONAL	Provisional S. American 1956
	Oman	S AMERICA	Peru
ORD SURVEY	Ordinance Survey	1956 PERU	
G BRITAIN	Great Britain 1936 - Mean for	PROVI S AMER	Provisional S. American 1956
1936 MEAN	England, Isle of Man, Scotland,	1956	Venezuela
	Shetland Islands, Wales	VENEZUELA	
ORD SURVEY	Ordinance Survey	PROVISIONAL	Provisional S. American 1956
G BRITAIN	Great Britain 1936 - England	S CHILEAN	Chile (South, Near 53°S) (Hito XVIII)
1936 ENGLAND		1963 S CHILE	
ORD SURVEY G ...	Ordinance Survey	PUERTO RICO	Puerto Rico
BRITAIN 1936	Great Britain 1936 - England,	VIRGIN	Puerto Rico, Virgin Islands
ENGLND WALES	Isle of Man, Wales	ISLANDS	
ORD SURVEY G ...	Ordinance Survey	QATAR	Qatar National
BRITAIN 1936	Great Britain 1936 - Scotland,	NATIONAL	Qatar
SCOTLAND	Shetland Islands	QORNOQ	Qornoq
ORD SURVEY	Ordinance Survey	GREENLAND	Greenland (South)
G BRITAIN	Great Britain 1936 - Wales	(SOUTH)	
1936 WALES		REUNION	Reunion
PICO DE	Pico de las Nieves	MASCARENE	Mascarene Islands
LAS NIEVES	Canary Islands	ISLANDS	
CANARY ISLES		ROME 1940	Rome 1940

ITALY
(SARDINIA)Italy (Sardinia)

RT 90Sweden

SANTO (DOS)Santo (DOS)
'65 ESPIRITO 1965 Espirito Santo Island
SANTO ISLAND

SAO BRAZSao Braz
AZORES Azores (Sao Miguel,
Santa Maria Islands)

SAPPER HILLSapper Hill 1943
1943 EAST East Falkland Island
FALKLAND ISLE

SCHWARZECKSchwarzeck
NAMIBIA Nambia

SELVAGEM Selvagem Grande
GRANDE Salvage Islands
SALVAGE ISLE

SOVIETSGS 85
GEODETIC Soviet Geodetic System 1985
SYSTEM 1985

S AMERICANSouth American 1969
1969 MEAN Mean for Argentina, Bolivia,
Brazil, Chile, Colombia, Ecuador,
Guyana, Paraguay, Peru,
Trinidad & Tobago, Venezuela

S AMERICANSouth American 1969
1969 ARGENTINA Argentina

S AMERICANSouth American 1969
1969 BOLIVIA Bolivia

S AMERICANSouth American 1969
1969 BRAZIL Brazil

S AMERICANSouth American 1969
1969 CHILE Chile

S AMERICANSouth American 1969
1969 COLOMBIA Colombia

S AMERICANSouth American 1969
1969 ECUADOR Ecuador

S AMERICANSouth American 1969
1969 ECUADOR Ecuador (Baïra, Galapagos)
GALAPAGOS

S AMERICANSouth American 1969
1969 GUYANA Guyana

S AMERICANSouth American 1969
1969 PARAGUAY Paraguay

S AMERICANSouth American 1969
1969 PERU Peru

S AMERICANSouth American 1969
1969 TOBAGO Trinidad & Tobago
AND TRINIDAD

S AMERICANSouth American 1969
1969

VENEZUELAVenezuela

SOUTH ASIASouth Asia

SINGAPORESingapore

TANANARIVETananarive Observatory 1925
OBSERVATORY Madagascar
1925
MADAGASCAR

TIMBALAITimbalai 1948
1948 BRUNEI Brunei, East Malaysia
E MALAYSIA (Sabah, Sarawak)

TOKYOTokyo
MEAN Mean for Japan, Korea, Okinawa

TOKYOTokyo
JAPAN Japan

TOKYOTokyo
KOREA Korea

TOKYOTokyo

OKINAWAOkinawa

TRISTAN DATristan Astro 1968
CUNHA Tristan da Cunha
ASTRO 1968

VITI LEVUViti Levu 1916
1916 FIJI Fiji (Viti Levu Island)

WAKEWake

ENIWETOK '60Eniwetok 1960

MARSHALL ISLMarshall Islands

WAKE ISLANDWake Island Astro 1952
ASTRO 1952 Wake Atoll

WGS 1972WGS 1972
GLOBAL Global Definition
DEFINITION

YACAREYacare
URUGUAY Uruguay

ZANDERIJZanderij
SURINAME Suriname

LOWRANCE AVIONICS FULL ONE-YEAR WARRANTY

“We”, “our”, or “us” refers to LOWRANCE AVIONICS, a division of LEI, the manufacturer of this product. “You” or “your” refers to the first person who purchases this product as a consumer item for personal, family, or household use.

We warrant this product against defects or malfunctions in materials and workmanship, and against failure to conform to this product’s written specifications, all for one year (1) from the date of original purchase by you. WE MAKE NO OTHER EXPRESS WARRANTY OR REPRESENTATION OF ANY KIND WHATSOEVER CONCERNING THIS PRODUCT. Your remedies under this warranty will be available so long as you can show in a reasonable manner that any defect or malfunction in materials or workmanship, or any non-conformity with the product’s written specifications, occurred within one year from the date of your original purchase, which must be substantiated by a dated sales receipt or sales slip. Any such defect, malfunction, or non-conformity which occurs within one year from your original purchase date will either be repaired without charge or be replaced with a new product identical or reasonably equivalent to this product, at our option, within a reasonable time after our receipt of the product. If such defect, malfunction, or non-conformity remains after a reasonable number of attempts to repair by us, you may elect to obtain without charge a replacement of the product or a refund for the product. THIS REPAIR, REPLACEMENT, OR REFUND (AS JUST DESCRIBED) IS THE EXCLUSIVE REMEDY AVAILABLE TO YOU AGAINST US FOR ANY DEFECT, MALFUNCTION, OR NON-CONFORMITY CONCERNING THE PRODUCT OR FOR ANY LOSS OR DAMAGE RESULTING FROM ANY OTHER CAUSE WHATSOEVER. WE WILL NOT UNDER ANY CIRCUMSTANCES BE LIABLE TO ANYONE FOR ANY SPECIAL, CONSEQUENTIAL, INCIDENTAL, OR OTHER INDIRECT DAMAGE OF ANY KIND.

Some states do not allow the exclusion or limitation of incidental or consequential damages, so the above limitations or exclusions may not apply to you.

This warranty does NOT apply in the following circumstances: (1) when the product has been serviced or repaired by anyone other than us, (2) when the product has been connected, installed, combined, altered, adjusted, or handled in a manner other than according to the instructions furnished with the product, (3) when any serial number has been effaced, altered, or removed, or (4) when any defect, problem, loss, or damage has resulted from any accident, misuse, negligence, or carelessness, or from any failure to provide reasonable and necessary maintenance in accordance with the instructions of the owner’s manual for the product.

We reserve the right to make changes or improvements in our products from time to time without incurring the obligation to install such improvements or changes on equipment or items previously manufactured.

This warranty gives you specific legal rights and you may also have other rights which may vary from state to state.

REMINDER: You must retain the sales slip or sales receipt proving the date of your original purchase in case warranty service is ever required.

This warranty does not apply to any database or its contents supplied initially with this product. For warranty information on the databases and their contents, please refer to the “Databases Limited Warranty” included with this product.

LOWRANCE AVIONICS

12000 E SKELLY DR

TULSA, OK 74128

Lowrance's UPS Return Service - U.S.A. Only

Lowrance Avionics and United Parcel Service (UPS) are proud to offer all of our customers free shipping for all units sent to us for repair or service. If you have to send this unit to the factory, and you are in the continental United States, use the enclosed UPS shipping label for easy, free shipping to our factory customer service department. There are six easy steps:

1. Call Lowrance at the toll-free number on the back of this manual for a Return Authorization (RA) number and instructions about what accessories to return. **Do not return a product to the factory without a Return Authorization (RA) Number!**
2. Pack your unit and any accessories in the original shipping container, if possible. **Be sure to include proof of purchase for warranty verification!**
3. Write a brief note detailing the problem you're having with the unit. Please include your name, address, and daytime telephone number.
4. Please include payment for non-warranty repairs. Check, money order, Visa, or MasterCard may be used.
5. Fill in your name, address, zip code, date, and RA number in the blanks provided on the UPS form included with your unit.
6. Attach the label to the shipping box, tear off the tab for your receipt and give the package to any UPS driver or take the package to any UPS Customer Center. You will not be charged for this shipment.

That's it! Your unit will be shipped to Lowrance's customer service department at no charge to you. Units under warranty will be returned to you at no charge.

NOTE!

Lowrance will pay UPS surface shipping charges both to and from the factory for this unit in the event it needs repair. Your unit is insured against loss or shipping damage when you use the enclosed UPS label.

This UPS shipping offer is good only in the continental United States (excludes Alaska and Hawaii).

**KEEP THIS LABEL!
YOU WILL NEED IT IF YOU EVER NEED TO RETURN YOUR UNIT TO
THE FACTORY FOR REPAIR.**

Accessory Ordering Information

To order accessories such as power cables, please contact:

1) Your local marine dealer. Most quality dealers that handle marine electronic equipment should be able to assist you with these items. Consult your local telephone directory for listings.

2) LEI Extras, Inc. P.O. Box 129 Catoosa, OK 74015-0129
or call
800-324-0045
(USA orders only.)

Lowrance Avionics may find it necessary to change or end our shipping policies, regulations, and special offers at any time. We reserve the right to do so without notice.

LOWRANCE DATABASES LICENSE AGREEMENT

THIS IS A LEGAL AGREEMENT BETWEEN THE END-USER WHO FIRST PURCHASES THIS PRODUCT AS A CONSUMER ITEM FOR PERSONAL, FAMILY, OR HOUSEHOLD USE (“YOU”) AND LOWRANCE ELECTRONICS, INC., THE MANUFACTURER OF THIS PRODUCT. (“WE”, “OUR”, OR “US”). USING THE PRODUCT ACCOMPANIED BY THIS LICENSE AGREEMENT CONSTITUTES ACCEPTANCE OF THESE TERMS AND CONDITIONS.

1. This License Agreement applies to the one or more databases that your product may contain. We refer to these singly as a “Database” and together as the “Databases.” Your product may thus include the “WBS Database” which contains worldwide background surface mapping data, the “SmartMap Database” which contains inland mapping data, or other Databases.
2. The Databases that your product may contain are licensed, not sold. We grant to you the nonexclusive, nonassignable right to use these Databases for supplemental navigation reference purposes, but only as long as you comply with the terms and conditions of this License Agreement. We reserve the right to terminate this license if you violate any aspect of this License Agreement. You are responsible for using official government charts and prudent navigation for safe travel.
3. The Databases housed in your product are protected by the copyright notices appearing on the product or its screen(s). You may NOT modify, adapt, translate, reverse engineer, decompile, disassemble, rent, lease, or resell any Database, and you may NOT create derivative works based upon any Database or its contents.. Any unauthorized reproduction, use, or transfer of a Database may be a crime and may subject you to damages and attorney fees.
4. This License Agreement will terminate immediately without prior notice from us if you fail to comply with or violate any of the provisions of this Agreement. Upon termination, you will promptly return all products containing one or more Databases to us.
5. Prices and programs are subject to change without notice.
6. This License Agreement shall be governed by the laws of the State of Oklahoma and comprises the complete and exclusive understanding between you and us concerning the above subject matter.
7. If you do not accept all terms and conditions, promptly return the product within 30 days of purchase. Please return using the enclosed UPS shipping label and include: Proof of Purchase, Name, Address, and Phone Number. Your purchase price and any applicable taxes will be refunded. Please allow 4-6 weeks to process your refund.

DATABASES LIMITED WARRANTY

“We”, “our”, or “us” refers to Lowrance Avionics, a division of LEI, the manufacturer of this product. “You” or “your” refers to the first person who purchases the product as a consumer item for personal, family, or household use. The Databases Limited Warranty applies to the one or more databases that your product may contain. We refer to each of these as a “Database” or together as the “Databases.” Your product may thus include the “WBS Database” which contains worldwide background surface mapping data, the “SmartMap Database” which contains inland mapping data, or other Databases.

We warrant to you that we have accurately compiled, processed, and reproduced the portions of the source material on which the Databases are based. However, we are under no obligation to provide updates to the Databases, and the data contained in the Databases may be incomplete when compared to the source material. WE MAKE NO EXPRESS OR IMPLIED WARRANTY OF ANY KIND ABOUT THE ACCURACY OF THE SOURCE MATERIAL ITSELF, INCLUDING BUT NOT LIMITED TO IMPLIED WARRANTIES OF MERCHANTABILITY OR FITNESS FOR A PARTICULAR PURPOSE.

If there is a defect in any Database, your exclusive remedy shall be, at our option, either a refund of the price you paid for the product containing the defective Database or a replacement of such product. WE WILL NOT UNDER ANY CIRCUMSTANCES BE LIABLE TO ANYONE FOR ANY SPECIAL, CONSEQUENTIAL, INCIDENTAL, OR OTHER INDIRECT DAMAGE OF ANY KIND.

Some states do not allow the exclusion or limitation of incidental or consequential damages, so the above limitations or exclusions may not apply to you.

This warranty does NOT apply in the following circumstances: (1) when the product has been serviced or repaired by anyone other than us, (2) when the product has been connected, installed, combined, altered, adjusted, or handled in a manner other than according to the instructions furnished with the product, (3) when any serial number has been effaced, altered, or removed, or (4) when any defect, problem, loss, or damage has resulted from any accident, misuse, negligence, or carelessness, or from any failure to provide reasonable and necessary maintenance in accordance with the instructions of the owner’s manual for the product.

We reserve the right to make changes or improvements in our products from time to time without incurring the obligation to install such improvements or changes on equipment or items previously manufactured.

This warranty gives you specific legal rights and you may also have other rights which may vary from state to state.

Your remedies under this warranty will be available so long as you can show in a reasonable manner that the defect occurred within one (1) year from the date of your original purchase, and we must receive your warranty claim no later than 30 days after such 1-year period expires. Your claim must be substantiated by a dated sales receipt or sales slip.

How to Obtain Service (Canadian Customers Only)

We back your investment in quality products with quick, expert service and genuine Lowrance replacement parts. If you need service or repairs, contact the Lowrance Factory Customer Service Department at the toll-free number listed below. A technician may be able to solve the problem and save you the inconvenience of returning your unit. You will be asked for your unit's serial number.

800-324-4740

Canada Only. Monday through Friday 8:00 A.M. - 8:00 P.M. Central Time.

When sending a product for repair, please do the following:

1. Always use the original shipping container and filler material the product was packed in when shipping your product.
2. Always insure the parcel against damage or loss during shipment. Lowrance does not assume responsibility for goods lost or damaged in transit.
3. For proper testing, repair, and service, send a brief note with the product describing the problem. Be sure to include your name, return shipping address, and a daytime telephone number.

How to Obtain Service (International Customers Only - Except Canada)

If you need service or repairs, contact the dealer in the country you purchased your unit.

**WARRANTY REPAIR WILL BE HONORED ONLY IN THE
COUNTRY UNIT WAS PURCHASED.**

Please follow the shipping instructions shown below on this page if you have to mail your unit to the dealer. For proper testing, repair, and service, send a brief note with the product describing the problem. Be sure to include your name, return shipping address, and a daytime telephone number.

Accessory Ordering Information - All Countries

To order accessories such as power cables or transducers, please contact:

1. Your local dealer. Most quality dealers that handle GPS navigation equipment should be able to assist you with these items. Consult your local telephone directory for listings.
2. Canadian customers only can write:
Lowrance/Eagle Canada, 919 Matheson Blvd., E. Mississauga, Ontario L4W2R7
or fax 416-629-3118

How to Obtain Service - U.S.A. Only

We back your investment in quality products with quick, expert service and genuine Lowrance® replacement parts. If you're in the United States and you have questions, please contact the Factory Customer Service Department using our toll-free number listed below. You must send the unit to the factory for warranty service or repair. Please call the factory before sending the unit. You will be asked for your unit's serial number. Use the following toll-free number:

800-324-4740

U.S.A. only. Monday through Friday 8:00 A.M. - 8:00 P.M. Central time, except holidays.

Your unit is covered by a full one-year warranty. (See page 79 inside this manual for complete warranty details.) If your unit fails and the failure is not covered by the original warranty, Lowrance has a flat-rate repair policy that covers your unit and accessories packed with the unit at the factory. There is a 180-day warranty on all non-warranty repairs from the factory, which is similar to the original warranty, but is for 180 days rather than one year. For further details, please call us at the above number.

Lowrance also gives you free UPS shipping from anywhere in the continental United States both to and from the factory for all warranty repairs. You can also use the enclosed UPS shipping label for non-warranty shipments. See page 80 for more information. Remember, non-warranty repairs are subject to Lowrance's published flat-rate charges and 180-day warranty.