

GARMIN GPS

GPS 65 Personal Navigator™



Owner's Manual



GARMINSM

GPS 65

Personal NavigatorTM

OWNER'S MANUAL

(Software Version 2.20 or above)

© 1992-1993 GARMIN, 9875 Widmer Road, Lenexa, KS 66215, USA

Printed in Taiwan.

All rights reserved. No part of this manual may be reproduced or transmitted in any form or by any means, electronic or mechanical, including photocopying and recording, for any purpose without the express written permission of GARMIN.

Information in this document is subject to change without notice. GARMIN reserves the right to change or improve their products and to make changes in the content without obligation to notify any person or organization of such changes or improvements.

November, 1993

190-00038-00 Rev. G

PREFACE

GARMIN thanks you for selecting our high performance, full featured Personal Navigator™. The GPS 65 represents our continued commitment to provide you with a portable navigation unit that is versatile, extremely accurate, and easy to use. We are confident you will enjoy using your unit for many years to come.

The GPS 65's rugged construction and quality components offer the reliability demanded by the harshest operating environments. It may be fixed mounted in marine and land vehicles. The unit may be operated from a 5-40 volt DC external power source. You can also use a 115- or 230-volt AC adaptor for planning trips at home.

This manual and accompanying quick reference guide provide complete information on safely operating the GPS 65 to its full potential. A practice voyage has been planned for you to practice your navigation skills using the built-in simulator. Afterwards, try a trip of your own to realize the value of the GPS 65 as your Personal Navigator™. If you have any questions or comments, our Product Support Department is eager to serve you. GARMIN is fully committed to your satisfaction as a customer.

**GARMIN International, Inc.
9875 Widmer Road
Lenexa, KS 66215
1-800-800-1020
(913) 599-1515**

CAUTION

The GPS system is operated by the government of the United States which is solely responsible for its accuracy and maintenance. The system is under development and is subject to changes which could affect the accuracy and performance of all GPS equipment. Although the GPS 65 is a precision electronic NAVigation AID (NAVAID), any NAVAID can be misused or misinterpreted, and therefore become unsafe. Use the GPS 65 at your own risk. To reduce the risk, carefully review and understand all aspects of this Owner's Manual and thoroughly practice operation using the simulator mode prior to actual use. When in actual use, carefully compare indications from the GPS 65 to all available navigation sources including the information from other NAVAIDs, visual sightings, charts, etc. For safety, always resolve any discrepancies before continuing navigation.

NOTE: This equipment has been tested and found to comply with the limits for a Class B digital device, pursuant to part 15 of the FCC Rules. These limits are designed to provide reasonable protection against harmful interference in a normal installation. This equipment generates, uses and can radiate radio frequency energy and, if not installed and used in accordance with the instructions, may cause harmful interference to radio communications. However, there is no guarantee that interference will not occur in a particular installation. If this equipment does cause harmful interference to radio or television reception, which can be determined by turning the equipment off and on, the user is encouraged to correct the interference by one or more of the following measures:

- Relocate the receiving antenna.
- Increase the separation between the equipment and the receiver.
- Connect the equipment to a different circuit from that which the receiver is connected.
- Consult the dealer or an experienced radio/TV technician for help.

TABLE OF CONTENTS

CHAPTER		PAGE
1	INTRODUCING THE GARMIN GPS 65	1-1
	1.1 Capabilities	1-1
	1.2 Operations	1-2
2	GETTING STARTED	2-1
	2.1 Front Panel	2-1
	2.2 Softkey Operation	2-1
	2.3 Cursor and Fields	2-2
	2.4 Keypad Operation	2-2
	2.5 Entering Data	2-4
	2.6 Viewing Messages	2-4
	2.7 Operating Modes	2-5
3	BASIC OPERATION	3-1
	3.1 Power On	3-1
	3.2 Satellite Status Pages	3-2
	3.3 Present Position	3-3
	3.4 Waypoints	3-5
	3.5 Waypoint List	3-6
	3.6 Autostore™	3-6
	3.7 Getting There Fast--GOTO	3-7
	3.8 Navigating To A Waypoint	3-8
	3.9 Man Overboard	3-11
	3.10 Sample Trip	3-11
4	ROUTES	4-1
	4.1 Navigating Using Routes	4-1
	4.2 Creating and Copying A Route	4-2
	4.3 Activating Routes	4-3
	4.4 Editing Routes	4-4
	4.5 Deleting Routes	4-4
	4.6 Active Route	4-5
	4.7 Route List	4-5

5	ADVANCED WAYPOINT FEATURES	5-1
5.1	Nearest Waypoints	5-1
5.2	Proximity Waypoints	5-1
5.3	Reference Waypoints	5-2
5.4	Waypoint Scanning	5-3
6	AUXILIARY FUNCTIONS	6-1
6.1	Operating Mode and Filters	6-1
6.2	Plotting Setup	6-2
6.3	Units/Heading Setup	6-3
6.4	Alarms and CDI Setup	6-4
6.5	Date/Time	6-5
6.6	Audio and Display Setup	6-6
6.7	Interface Setup	6-6
6.8	Map Datum Selection	6-7
6.9	Beacon Receiver Setup	6-8
6.10	Sunrise/Sunset Planning	6-9
6.11	Trip and Fuel Planning	6-10
6.12	Messages	6-11

APPENDICES

A	MESSAGES	A-1
B	GLOSSARY AND NAVIGATION TERMS	B-1
B.1	Definitions	B-1
B.2	Course To Steer (CTS)	B-3
C	INSTALLATION AND MAINTENANCE	C-1
C.1	Specifications	C-1
C.2	Electrical Wiring	C-3
C.3	Installation	C-5
C.4	Maintenance	C-8
C.5	Product Support	C-8
D	MAP DATUMS	D-1
E	UTC TIME TO LOCAL TIME OFFSET	E-1

CHAPTER 1

INTRODUCING THE GARMIN GPS 65

1.1 CAPABILITIES

The GPS 65 provides a host of powerful capabilities which were previously found only in much larger systems:

- **Performance:** MultiTrac™ receiver tracks and uses up to eight satellites with high sensitivity, fast first fix, and continuous navigation updates.
- **Ease of Use:** Graphic screens and intuitive guidance from the display offer ease of operation.
- **Navigation:** Stores 250 alphanumeric waypoints; 10 reversible routes of 20 waypoints each. GOTO function sets instantaneous course to waypoint of your choice. AutoStore™ function builds routes as you go. A flashing message annunciator updates navigation status.
- **Personalized:** Customize your unit by selecting distance and speed units, Course Deviation Indicator (CDI) sensitivity, keypad and display features, map datums, and interface options.
- **Man Overboard:** This function sets an instantaneous course to the captured position for rapid response to an emergency situation.
- **Trip Planning:** Analyze distance, time, and fuel requirements for your trip. Compute time of sunrise/sunset at your destination.
- **Alarms:** An alarm clock and timer allow the GPS 65 to watch the clock for you. Arrival and anchor drag alerts help you safely navigate your craft.
- **Interfaces:** Interface with marine autopilots and graphic plotters using NMEA 0180/0182/0183 outputs.
- **Differential Ready:** Differential input installed to accept future GARMIN DGPS components.

1.2 OPERATIONS

The GPS 65 is designed for fixed operations only. The unit may be operated from external 5-40 volt DC power using the power/data cable or cigarette lighter adapter, or external AC power using an AC adapter.

The unit may be operated using vehicle power supplied through the power/data cable. In addition to supplying power to the unit, the power/data cable allows you to interface your GPS 65 with other marine electronic devices such as plotters or autopilots.

The Marine/RV remote antenna should be mounted in a position that provides an unobstructed view of the sky. Situate the antenna upright where it will not be blocked by objects or people (signal reception through thin fabric such as canvas may be adequate, but will be degraded). This weather-proof antenna includes 30 feet of low-loss antenna cable. The antenna has been constructed to thread onto a standard 1" antenna mount, which is readily available from your local marine accessories dealer.

A magnetic mount antenna is also available. This weather-proof antenna includes 10 feet of low-loss antenna cable. A cigarette lighter adapter cable may be used to power the unit in vehicle applications.

CHAPTER 2

GETTING STARTED

2.1 FRONT PANEL

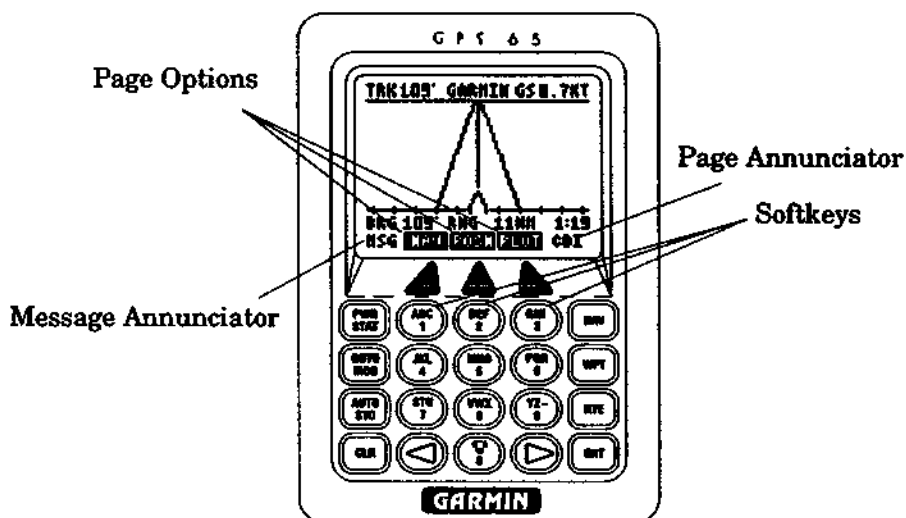

The front panel consists of a 20-key keypad with a 85 x 64-pixel LCD display. Both the display and keypad may be illuminated for nighttime operation.

2.2 SOFTKEY OPERATION

Information displayed on the LCD is commonly referred to as a "page." The GPS 65 works with softkey operation. At the bottom of the screen is a list of page options. To select a different page, press the appropriate softkey below the desired menu option. Please note that the menu options must be highlighted in order to use the softkeys. On the bottom line, extreme right, is the page annunciator, which indicates the current page you are viewing.

2.3 CURSOR AND FIELDS

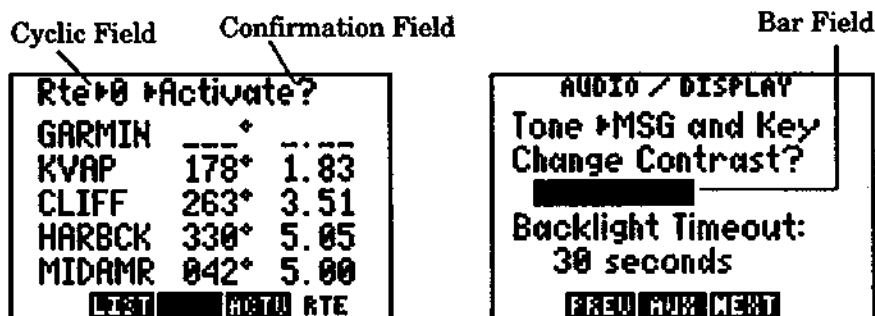

The area of the page which is highlighted in reverse video is called the **cursor**. The cursor may be moved to locations on the page called **fields** which allow you to enter data or change options. You will encounter five types of fields.

- **Numeric fields** accept numbers only.
- **Alphanumeric fields** accept numbers as well as letters.
- **Cyclic fields** allow selection from several available options. A cyclic field is preceded by a prompt (→). You may cycle through the choices by pushing CLR.
- **Confirmation fields** allow you to indicate your approval. For example, you will be asked to confirm that you want to delete a waypoint. Confirmation fields always end with a "?" character. Press ENT to approve the confirmation field.
- **Bar fields** allow an adjustable scale entry with the length of the bar representing the minimum to maximum setting. Use your arrow keys to make adjustments in bar fields.

2.4 KEYPAD OPERATION

PWR
STAT

The PWR/STAT key is a dual function key that controls unit power and system status. Pressing this when the unit is off will turn the unit on. To turn the unit off, press and hold PWR/STAT until the display is blank.

Pressing PWR/STAT momentarily while the unit is on will take you to the status pages (see Section 3.2). If the message annunciator is flashing and the tone sounds, you may push PWR/STAT to view the message.

**GOTO
MOB**

Pressing **GOTO/MOB** once allows you to initiate the **GOTO** function, setting an instantaneous course to any waypoint (see Section 3.7). Pressing **GOTO/MOB** twice allows you to initiate the **Man Overboard** function, setting an immediate course to the captured position (see Section 3.9).

**AUTO
STO**

Pressing **AUTOSTORE** allows you to capture your present position instantaneously (see Section 3.6).

NAV

Pressing **NAV** selects the **Navigation Pages** which allow you to view navigation information and the **Plot Page** (see Section 3.8).

WPT

Pressing **WPT** selects the **Waypoint Pages** which allow you to create, edit, delete, and rename waypoints. In addition, you may view nearest waypoints or proximity waypoints (see Sections 3.4, 3.5 and Chapter 5).

RTE

Pressing **RTE** selects the **Route Pages** which allow you to edit, review, activate, and delete routes (see Chapter 4).



Pressing either of the arrow keys allows you to move the cursor, scroll through information lists, and enter letters of the alphabet.



The alphanumeric keys allow you to enter letters and numbers. Use the arrow keys to select the desired letter or number.



Pressing this key while the cursor is not on a numeric or alphanumeric field allows you to change the backlight level. There are two backlighting levels.

CLR

Pressing **CLR** erases information in the cursor field. If the cursor is over a cyclic field, pressing **CLR** will toggle through several available options.

ENT

Pressing **ENT** confirms an entry or selection.

2.5 ENTERING DATA

To enter data you must first move the cursor under the desired field by pressing the right or left arrow key.

To enter a number...

- Press the key that is labeled with the desired number. The numbers will fill in from the right side of the field and move to the left as each new number is entered. For example, if you wish to enter "51" in a three space field, you must press the 5 and 1 keys in that order. **NOTE:** To enter a number into an alphanumeric field, press the desired key followed by two presses of either the right or left arrow key.
- Press CLR if you enter an incorrect number.
- Press ENT when you have filled all significant digits of the field with numbers.

To enter a letter...

- Press the key that is labeled with the desired letter.
- Press the right or left arrow key until the desired letter is displayed.
- Press CLR if you enter an incorrect letter.
- Press ENT when all the characters are entered.

The GPS 65 features a keypad feedback tone which will sound each time you press a key. If you enter data which is not appropriate for the field, the feedback tone will quickly sound three times indicating an error. The keypad feedback tone can be turned off if you wish (see Section 6.6).

2.6 VIEWING MESSAGES

From time to time, the GPS 65 will use a message to tell you of conditions needing attention. When the GPS 65 has a new message, the MSG annunciator will flash. When this occurs, press PWR/STAT to view the new message(s). Press PWR/STAT again to see the page you were viewing prior to reading your message.

While the MSG annunciator is flashing, the GPS 65 will also generate a tone to alert you of the message. (If your unit is connected to an external alarm, it will also be activated.) Messages that demand

immediate attention such as an arrival alarm generate a quick tone that will not stop until you view the message. All other messages generate a slow tone that will cease after 15 seconds. The message tone may be turned off if you wish (see Section 6.6).

Important messages will remain on the Message Page after being viewed. If this occurs, the MSG annunciator will be in view but will not flash (if no messages exist, the MSG annunciator will not be visible). To review these messages, press PWR/STAT to reveal the status menu options. Then press the key underneath the "AUX" page option. With the arrow keys, scroll to "Messages" and press ENT.

Refer to Appendix A for a complete list of GPS 65 messages.

2.7 OPERATING MODES

Three modes are available which will allow you to operate your GPS 65 in the way which best suits your needs (see Section 6.1).

Normal mode should be selected for most applications, especially high dynamics operations.

Battery Saver mode is available for applications where vehicle battery life or current drain is critical.

Simulator mode allows you to simulate the operation of the GPS 65 while on board (and moored), parked in your vehicle, or at home using the optional AC adaptor. The simulator mode can be used while learning to operate your GPS 65 and is ideal for planning routes and entering waypoints. Keep in mind that the GPS 65 is not tracking satellites in the simulator mode. **YOU SHOULD NEVER ATTEMPT TO USE THE SIMULATOR MODE FOR ACTUAL NAVIGATION.**

If you are using your GPS 65 for the first time, you are encouraged to review Chapter 3 which introduces the GPS 65's basic features, and Chapter 6 on custom setups. Afterward, you may want to read through the rest of this manual and make further use of the built-in simulator to practice with the advanced features.

CHAPTER 3

BASIC OPERATION

3.1 POWER ON

After you turn your GPS 65 on, it will conduct a series of self tests and display the following notice:



Following completion of the tests, the Satellite Bar Graph Page (see Section 3.2) will be displayed, and the GPS 65 will begin acquiring satellites.

After a position is found (and if no keys have been pressed), the Position Page (see Section 3.3) will be displayed, and the unit is ready for normal operation.

When four or more satellites with good geometry are available, the GPS 65 will automatically operate in the 3D mode in which latitude, longitude, and altitude are computed. If only three satellites are available, the unit will operate in 2D mode in which only latitude and longitude are computed. When operating in the 2D mode, the unit will use the last computed altitude or your last entered altitude. (Section 3.3 describes how you may enter the altitude.)

Your GPS 65 will automatically update satellite orbital data as it operates. If you have not operated your unit for a period of six months or longer, it will take approximately 15 minutes to search the sky and collect new orbital data. You will be informed when your unit is searching the sky with the message "Searching the Sky." Once satellite orbital data is collected, it will be stored in memory. The memory is maintained by an internal battery, therefore the data will not be lost when you turn your GPS 65 off.

3.2 SATELLITE STATUS PAGES

There are four status pages available by pressing PWR/STAT. Three pages display satellite tracking status, and the fourth is a menu of auxiliary functions (messages, setups, and utilities). The softkeys at the bottom of each page allow selecting pages: BAR (bar graph), STAT (status), SKY (skyview), and AUX (auxiliary menu). You may also cycle through these pages by repeatedly pressing PWR/STAT.

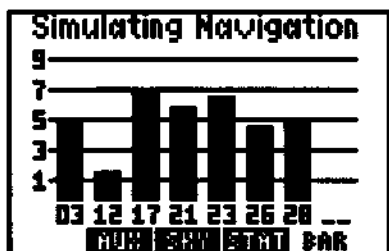

* To view the Satellite Status Page, press softkey underneath the STAT banner.



Satellite Bar Graph

The Satellite Bar Graph shows the signal quality of each visible satellite graphically. The receiver status is also shown at the top of the screen. In this example, the unit is simulating navigation. The satellite numbers (1-32) are represented along the bottom of the graph; signal quality (1, weakest to 9, strongest) is represented along the side. If a satellite is visible but not tracked, the signal quality will be blank. If differential corrections are available for a satellite, a "D" will appear at the bottom of the signal strength bar for that satellite. (See Section 6.7 for DGPS setup instructions.)

Satellite Status Page

The Satellite Status Page shows the ID, azimuth, elevation, and signal quality of each visible satellite in a table format. The receiver status, again, is displayed at the top of the screen, as well as the dilution of precision (DOP) and estimated position error (EPE). (For more information about unfamiliar terms, see Appendix B.)

Satellite ID	Azimuth	Elevation	Signal Quality
03	178°	29°	5
12	127°	10°	1
17	113°	73°	8
21	282°	36°	5
23	332°	68°	8
26	045°	26°	4
28	300°	28°	4
--	--	--	--

* Press SKY Softkey To display Satellite Skyview.



Satellite Skyview

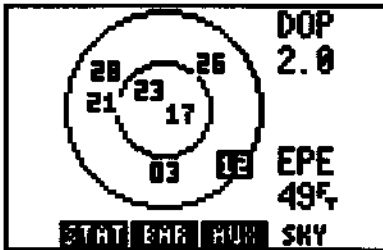

* Press **AUX**
Softkey to
display the
Auxiliary Menu
Page.



The Satellite Skyview Page shows the azimuth and elevation of each visible satellite in a graphicskyview format. Additionally, the DOP and EPE are displayed. The azimuth and elevation are useful in determining whether a satellite signal is blocked by buildings, mountains, or other obstructions. If a satellite is not currently being tracked, it will be displayed in reverse video on the screen.

Auxiliary Menu



The Auxiliary Menu Page enables the selection of various setup and utility functions by moving the cursor to an item with the arrow keys and pressing ENT. Each setup and utility page is described in detail in Chapter 6.

3.3 PRESENT POSITION

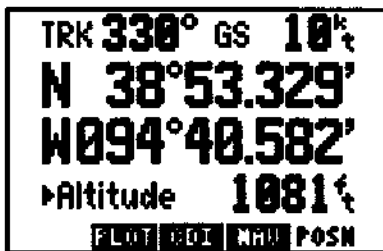

As mentioned earlier, the Position Page is automatically displayed once a position is obtained. This page displays track, ground speed, latitude and longitude relative to the selected map datum (see Section 6.8), as well as a choice of altitude above mean sea level (MSL) or time (cyclic field). (Note: Time information will not be displayed when the GPS 65 is acquiring satellites.)

Position Page

When the GPS 65 is performing 2D navigation, the last known altitude will be used in the latitude/longitude computation. If the altitude is not accurate within a few hundred feet, you should manually enter your altitude.

To enter the altitude (2D only)...

- Use an arrow key to move the cursor under the altitude.
- Enter the altitude. If your antenna is mounted on a high mast, make sure you add the mast height. (Remember to complete the data entry by pressing ENT.)

During initial satellite acquisition, the displayed position is the last computed position stored in the GPS 65. If your position has moved several hundred miles or more with the power off, the unit may go into the AutoLocate™ mode. This process can take up to ten minutes. Alternatively, you may enter a more accurate initial position to speed up the acquisition process. (You may also change the position at any time while you are in simulator mode.)

To enter the latitude/longitude...

- Use an arrow key to place the cursor on the latitude hemispheric designation (far left).
- Check the hemispheric designation (“N” or “S”) of the latitude. If it is correct, go to the next step. If it is incorrect, press CLR until the correct hemispheric designation is displayed.
- Place the cursor on the latitude field and enter the latitude. Depending on the position format selected (see Section 6.3), you will enter the latitude in one field (degrees only), two fields (degrees/minutes), or three fields (degrees/minutes/seconds or UTM). You must press ENT for each field to confirm the data entry.
- Check the hemispheric designation (“E” or “W”) of the longitude in the same manner as above for latitude.
- Enter the longitude (remember to complete the data entry by pressing ENT).

3.4 WAYPOINTS

The GPS 65 allows you to create, store, and use 250 alphanumeric waypoints. A waypoint consists of a name (up to six letters and/or numbers), its latitude/longitude location, last time/date of modification, and a one-line comment. There are four waypoint pages. The softkeys at the bottom of each page allow the selection of each page: WPT (waypoint definition), NRST (nearest waypoints), PROX (proximity waypoints), and LIST (waypoint list). To start the waypoint pages, press WPT. The Nearest and Proximity Waypoint Pages are covered in Chapter 5.

Waypoint Definition

If you are not already on this page, press the WPT softkey. It allows you to review, create and modify waypoints. The cyclic field allows you to display one of the following: 1) the date and time the waypoint location was last modified, 2) a one-line comment of the waypoint (up to 20 characters), or 3) range and bearing from a reference waypoint.

WPT: GARMIN
N 38°56.995'
W 094°44.782'
*DATE/TIME
31-DEC-89 00:00
LIST FROM NRST WPT

To create, modify or review a waypoint

- Move the cursor to the waypoint name field, then enter the desired waypoint name.
- To create or modify position, enter the waypoint latitude and longitude as described in Section 3.3 on the previous page. (NOTE: If a waypoint is being used for navigation, its position cannot be modified. An attempt to modify the position of such a waypoint will result in the message "Can't Chg Activ WPT.")

3.5 WAYPOINT LIST

The Waypoint List Page allows viewing of the stored waypoints in the unit. The list may be scrolled, with the arrow keys, to view all the waypoints. From this page, waypoints may be selected for deletion, renaming, or to activate a direct GOTO. (See Section 3.7.)

CLIFF	GARMIN
KRULL	KVAP
MIDAMR	MOB
RZRBCK	WIDMER
WLDCAT	WPT1
WPT2	-----
FROM NEXT PAGE LIST	

To delete a waypoint...

- With the arrow keys, place the cursor on the desired waypoint.
- Press CLR and ENT.
- The Confirmation Page is displayed. Press ENT to confirm or CLR to cancel.

NOTE: If you attempt to delete a proximity or route waypoint, a message will be displayed. You must delete the proximity alarm or the route before you can delete the waypoint.

To rename a waypoint...

- With the arrow keys, place the cursor on the desired waypoint.
- Type in a new name for the waypoint and press ENT.
- The Confirmation Page is displayed. Press ENT to confirm the name change or CLR to cancel.

3.6 AUTOSTORE

The AutoStore™ function allows you to capture your position at the touch of a button for future reference. This function saves your current position in a waypoint. Additionally, you may record your navigation path by inserting the captured waypoints into a route (see Section 4.6).

The AutoStore™ Page displays the waypoint name, captured position, and optional storage route. An AutoStore™ waypoint name is pre-assigned as a three digit number. You may change this to any name you desire. Autostore™ waypoints may be used for any waypoint operation and will be part of the 250 available waypoints.

The AutoStore™ Page displays the waypoint name, captured position, and optional storage route. An AutoStore™ waypoint name is pre-assigned as a three digit number. You may change this to any name you desire. Autostore™ waypoints may be used for any waypoint operation and will be part of the 250 available waypoints.

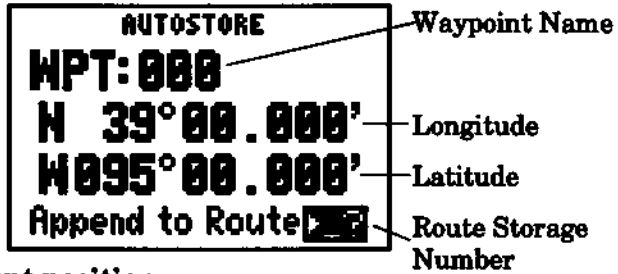

To capture present position...

- Press AUTOSTO. The pre-assigned waypoint name is on line 1. NOTE: The AutoStore™ location is captured as soon as you press AUTOSTO. This allows you all the time you need to change the waypoint name and/or confirm the Autostore.
- If you wish to give the waypoint a different name, move the cursor to the waypoint name field and enter the name of your choice. Press ENT. If you enter a waypoint name already used, you will be informed with the message, "WPT Exists [name]." Enter a different name if this occurs.
- Press ENT on a blank route storage number field to save the waypoint. If the route storage number field is not blank, the waypoint will be added to the route shown. (In Chapter 4, we will discuss building a route with AutoStore.)

3.7 GETTING THERE FAST--GOTO

The GOTO function allows you to quickly set a course from your position to any waypoint.

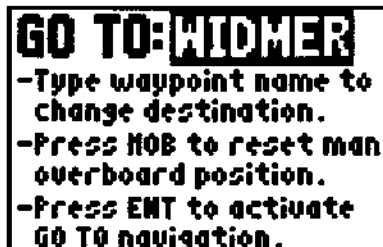

To activate the GOTO function...

- Press GOTO. The above page will be displayed with the cursor on the GOTO waypoint field. If the GPS 65 is currently navigating to a waypoint, that waypoint will be offered as the default GOTO waypoint. If the waypoint field is blank or the waypoint shown is not the desired destination, type the new name right over the old name. NOTE: If a non-existent waypoint name is entered, the Waypoint Definition Page will appear to give you the opportunity to create the waypoint (see Section 3.4).
- Confirm the default GOTO waypoint by pressing the ENT key. The NAV Page will be displayed. (The D-Bar on the CDI will be re-centered at this point, see Section 3.8 below.)

Alternatively, the GOTO function may be quickly activated from many pages (e.g. the Nearest Waypoint Page or the Waypoint List) by placing the cursor over the desired waypoint name and pressing the GOTO key. The GOTO Page will be displayed with the cursor on the GOTO waypoint name. The GOTO function will be activated when the ENT key is pressed.

To cancel the GOTO function...

- Press GOTO.
- Press CLR. The GOTO waypoint name will become blank.
- Press ENT. The GPS 65 will start to navigate using the active route, if it has been programmed (see Chapter 4). Otherwise, the GPS 65 will stop computing waypoint navigation data.

3.8 NAVIGATING TO A WAYPOINT

There are four navigation pages available from the NAV key. You may cycle through the following with softkeys at the bottom of each page: NAV (navigation summary), CDI (graphic course deviation indicator), PLOT (graphic plotter), and POSN (Present Position Page).

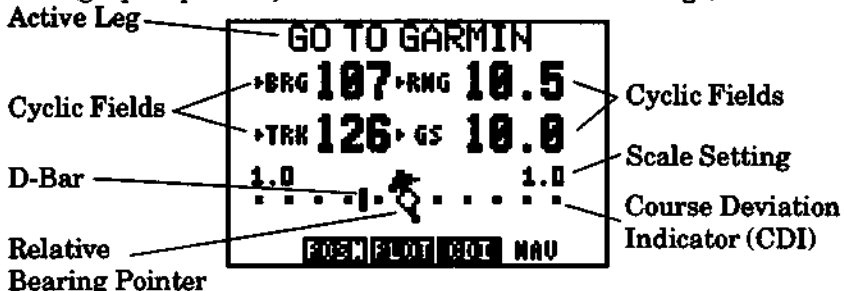

Navigation Summary

The Navigation Summary Page displays direction, distance and speed information to direct you along a route or a GOTO destination. The active leg (route) waypoints or GOTO waypoint is shown at the top of the screen. The CDI is at the bottom of the page. Current CDI scale setting is shown at each end of the scale. This is replaced by the cross track distance if the D-Bar goes off the scale. A relative bearing pointer at the center of the CDI indicates the bearing to the waypoint relative to the current track (TRK).



* Press the softkey under CDI.



Notice that this page has four cyclic fields available. The field options are as follows:

Field #1 (top left) provides a choice of: (a) bearing to destination waypoint (BRG), (b) course to steer waypoint (CTS), (c) desired track (DTK), (d) ground track (TRK), or (e) turn (TRN).

Field #2 (top right) provides a choice of: (a) range to destination waypoint (RNG), (b) cross track error (XTK), (c) along track distance (ATD), or (d) distance made good, back to starting point (DMG).

Field #3 (bottom left) provides a choice of: (a) ground track (TRK), (b) course made good (CMG), or (c) ground speed (GS).

Field #4 (bottom right) provides a choice of: (a) ground speed (GS), (b) estimated time enroute (ETE), (c) estimated time of arrival (ETA), or (d) velocity made good (VMG). (See Appendix B for a description of navigation terms.)

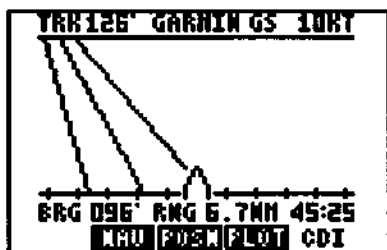

* Press the softkey under PLOT.



Course Deviation Indicator

The CDI Page shows a graphic "highway" display. The active waypoint is shown at the top of the screen. Navigation values for Track (TRK), Ground Speed (GS), Bearing (BRG), Range (RNG), and Estimated Time Enroute (bottom right) are shown. The center-line of the highway represents the desired

track. The outer lines give a perspective view of the distance to a waypoint. As the waypoint comes into range, it will be displayed and the outer lines will become parallel.

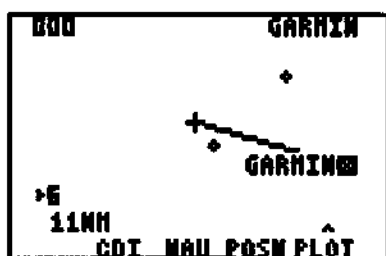

Press the POSN softkey.



Plot Page

The Plot Page shows a graphic top view of your course. The destination waypoint is shown at the top right of the screen. Your present position is shown as a plus (“+”) sign in the middle of the page. The track history and/or the active route are shown as a solid line. (Plotting of ground track and active route is user-selectable, see Section 6.2.) Nearby waypoints are displayed as diamonds. You may view the

waypoint name by scrolling to the point with the arrow keys. A GOTO may be performed by pressing GOTO while the cursor is on the waypoint.

The scale distance for the screen (distance represented by height of screen) is at the lower left corner of the screen. The scale number (directly above the scale distance) may be changed by moving the cursor to the scale number and pressing CLR, or by entering a new number (0-9). Finally, the Plot Page can be oriented as a “North up”, “Ground Track Up”, or “Desired Track Up” display (see Section 6.2).



Position Page

The Position Page is described in Section 3.3. Please refer to that section for further information.

3.9 MAN OVERBOARD

The Man Overboard function allows you to set an instantaneous course to a captured position, providing rapid response to an emergency situation.

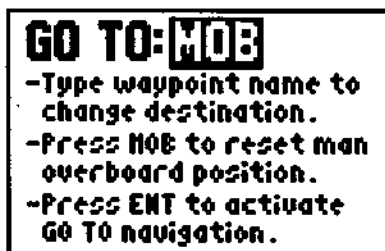

To activate the Man Overboard function...

- Press MOB twice. The above page will be displayed and the present position will be captured in a waypoint named, "MOB."
- Press ENT to navigate to the Man Overboard waypoint. A navigation page will be displayed; select the desired page with the softkeys.

3.10 SAMPLE TRIP

Now that you have gained a basic understanding of the GPS 65, you are ready to embark on a sample trip.

Your GPS 65 is factory initialized with a position of N39°, W095°. A waypoint named GARMIN, located at GARMIN's Lenexa, Kansas facility, is also provided.

Just for fun, let's go to GARMIN! Turn on your GPS 65. The power on notices will be displayed followed by the Satellite Bar Graph. The GPS 65 is ready to accept your commands.

```

Op Mode Plotting
Units:Hdg Alarm:CDI
Date:Time Audio:Dspl
Intrface Map Datm
Bcn Rcvr Sun Plan
Trip Plan Messages
SKY STAT BAR AUX
  
```



```

Op Mode Plotting
Units:Hdg Alarm:CDI
Date:Time Audio:Dspl
Intrface Map Datm
Bcn Rcvr Sun Plan
Trip Plan Messages
SKY STAT BAR AUX
  
```

ENT

```

OPERATING MODE
▶ Simulator

FILTERS
Position ▶ automatic
Velocity ▶ automatic
PREV FIRM NEXT
  
```

NAV

* Plus POSN Softkey if needed

```

TRK 288° GS 0.0 kt
N 39°00.000'
W 095°00.000'
▶ Time 18:22:46
PLOT INFO MENU POSN
  
```

Select the simulator mode...

- Press PWR/STAT to select a Status Page.
- If the Auxiliary Page is not displayed, press the softkey underneath the AUX banner to select it.
- Use the right arrow key to highlight "Op Mode", press ENT.

- If the operating mode field does not already display "Simulator", move the cursor with the arrow keys to that field, and press CLR until it does, followed by ENT. The unit is now ready to start the simulation.

Check the present position...

- Press NAV to display a navigation page.
- If the Present Position Page is not displayed, press the POSN softkey to select it. Note the present position. We will change the position to N39°W95°. (If the unit is set to display UTM coordinates, refer to Section 6.3 to change the coordinates to latitude and longitude.)

- Move the cursor to the latitude hemispheric designator with the arrow keys. Press CLR if you need to change this designator from "S" to "N". Press ENT.
- With the cursor on the latitude degrees, press "3" and "9", then ENT. (You may need to enter "0" for minutes and/or seconds to clear these fields, if they are shown.)
- Move the cursor to the longitude hemispheric designator. Follow the same sequence as above to complete longitude entry.

NOTE: The sample illustrations in this section assume that the factory default settings, including the selection of nautical units (knots, nautical miles), have not been changed. If these settings have been changed, the unit may display slightly different data than presented here. Changing the unit set-ups is covered later in Chapter 6.

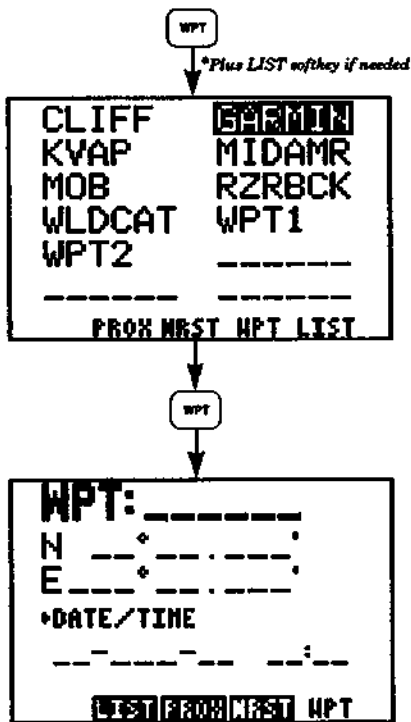

Check the GARMIN waypoint...

- To verify that the "GARMIN" waypoint is in memory, press WPT to select a waypoint page.
- If the Waypoint List Page is not displayed, press the LIST softkey to select it. Verify that the waypoint, "GARMIN", is on the list. If it is, you may skip the next three steps. **NOTE:** If the Waypoint List Page is full, use the arrow keys to scroll through the rest of the list until you locate the "GARMIN" waypoint.
- If the "GARMIN" waypoint is not listed, you must add it to the GPS 65's memory before you can activate the GOTO function. Press the WPT softkey.
- Move the cursor over the waypoint name field with the arrow keys. Enter "G", "A", "R", "M", "I", "N". Press ENT. Remember to use the arrow keys to select the letter you

A Faster GOTO...

At this point, we will take a very brief detour. You may recall from Section 3.7 that there is an alternative to typing all those letters in. Let's try it.

- First we must cancel the existing GOTO by pressing GOTO/MOB, CLR, and ENT. This calls up the GOTO Page, clears the destination and then confirms that no GOTO destination is desired.

```
CLIFF  GARMIN
KVAP   MIDAMR
MOB    RZRBCK
WLDCAT WPT1
WPT2   -----
-----
FROM CLRST WPT LIST
```



```
CLIFF  GARMIN
KVAP   MIDAMR
MOB    RZRBCK
WLDCAT WPT1
WPT2   -----
-----
FROM NRST WPT LIST
```

GOTO
MOB

```
GO TO: GARMIN
- Type waypoint name to
  change destination.
- Press MOB to reset man
  overboard position.
- Press ENT to activate
  GO TO navigation.
```

ENT

- Select the Waypoint List Page by pressing WPT and then the LIST softkey, if needed.

- With the right arrow key, move the cursor to the GARMIN waypoint.

- Press GOTO/MOB. The waypoint "GARMIN" is automatically carried over to the GOTO Page. (You can "import" waypoints to the GOTO Page from several other pages, including the Nearest Waypoint Page and the Plot Page, simply by highlighting the desired waypoint.)



- Press ENT. A navigation page is then displayed.
- Select the NAV Summary Page with the NAV softkey. Now back to our trip.

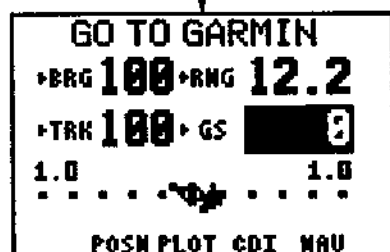

Set the Simulation Speed...

- With the arrow keys move the cursor to the ground speed field. (If this field does not currently indicate "GS", for ground speed, highlight that field with the left arrow key and press CLR until it does.)



- Enter a ground speed of 15 knots by pressing "1", "5", and ENT. (The GPS 65 will accept speeds of up to 90 knots.) The simulation speed is now set and the GPS 65 is simulating a trip from coordinates N39° W95° to the "GARMIN" waypoint (our Lenexa, KS facility).

Examine the Navigation Information...

At this point, you can explore the capabilities of the GPS 65. While you are on the Navigation Summary Page, you may want to examine other information not currently displayed (see Section 3.8).

- As the unit is navigating, you will notice the Range (RNG) to GARMIN decreasing. If you wish to see the distance back to where you started from, highlight this field (top right) with the arrow keys, and press CLR until distance made good (DMG) is displayed.

- Highlight the ground speed (GS) field (bottom right) and press CLR until the estimated time enroute (ETE) is displayed.
- Highlight the ground track (TRK) field (bottom left) and press CLR until groundspeed (GS) is displayed.
- Highlight the bearing (BRG) field (top left) and press CLR until ground track (TRK) is displayed.

You now have an entirely different Navigation Summary Page that should look something like this:

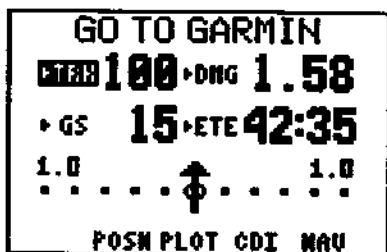

Let's Look at a Different Navigation Page...



- Move the cursor to the page options with the arrow keys.
- Select the Graphic CDI Page with the CDI softkey, (the "3" key in this case).

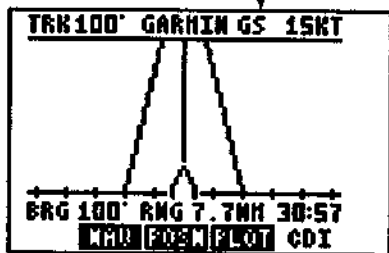

- The Graphic CDI Page shows the "highway" display. Note the ground track (TRK), destination waypoint, and ground speed (GS), on the top line. On the bottom line, bearing (BRG), range (RNG), and estimated time enroute (ETE), are displayed.



TRK 100° GS 15^k
 N 38°58.662'
 W094°53.200'
 ▶Time 15:25:58
 PLOT CDI NAV POSN



TRK 100° GS 15^k
 N 38°58.202'
 W094°50.875'
 ▶Altitude 1081^{ft}
 PLOT CDI NAV POSN



TRK 100° GS 15^k
 N 38°57.949'
 W094°49.593'
 ▶Altitude 1081^{ft}
 PLOT CDI NAV POSN



100 GARNIN
 ▶0
 0.2NM
 PLOT

Our Next Stop, the Present Position Page...

- Select the Present Position Page with the POSN softkey. Note that ground track (TRK) and ground speed (GS) are shown on the top line, followed by the current latitude and longitude on the next two lines.
- Highlight the cyclic field at the bottom of the page and toggle between current time and altitude with CLR.

The Plot Page (last one)...

- Move the cursor to the page options with the arrow keys.
- Select the Plot Page with the PLOT softkey.

The Plot Page will plot your ground track and/or an active route. (The setups for this page are covered in Section 6.2.) The top left corner indicates a "Track Up" display. A "North Up" display would be shown as "000" and a "Desired Track Up" display is also available. The top right corner shows the destination waypoint.

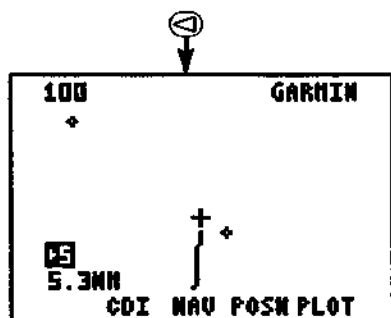

The scale setting is shown in the bottom left corner.

- Highlight the scale setting field with the arrow keys and change the scale setting with CLR. You may also change the scale settings with the number keys (0-9).

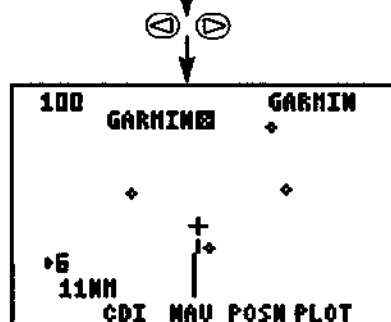

Finally, you may identify any waypoint shown on the Plot Page.

- Select a scale setting that allows you to see the destination waypoint (GARMIN).
- With the arrow keys, highlight the waypoint shown on the Plot Map. Once highlighted, the waypoint name is shown.



Experiment with your GPS 65.

You are on your way to mastering the GPS 65. If you let the simulator run, you will eventually get a message, "Approaching GARMIN", just prior to reaching the waypoint. Press PWR/STAT to view the message; and again to return to the Plot Page.

You may also want to:

- Press NAV, WPT, GOTO, or any other key to become more familiar with the available pages.
- Practice using the softkeys and cyclic fields to display new information.
- Change the simulation speed (faster or slower).
- Read Chapter 6 on Unit Customization and set up the unit to your preference.
- Stop the simulation. You can stop the simulation by turning the unit off (press and hold PWR/STAT), or go to the "OP Mode" set up and change to the "Normal" or "Battery Saver" modes (see Section 6.1).

CHAPTER 4

ROUTES

4.1 NAVIGATING USING ROUTES

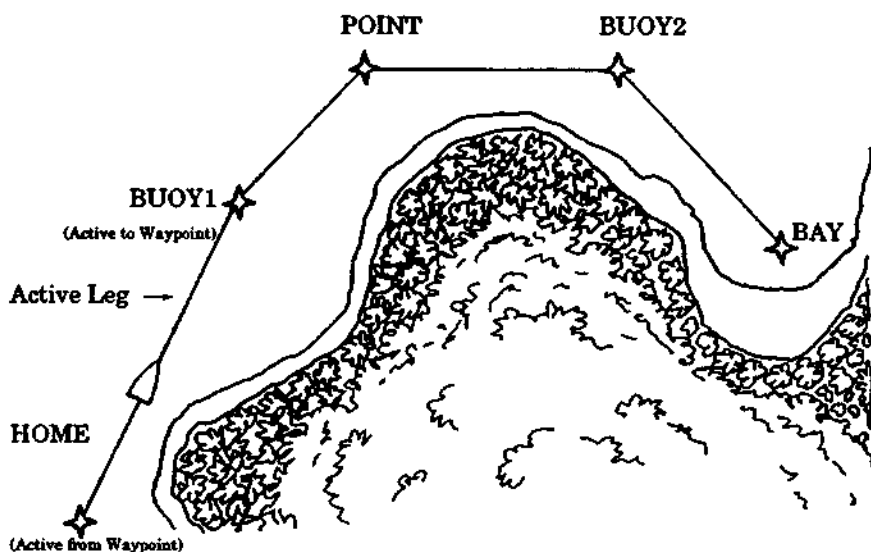

The GPS 65 offers a route navigation feature for you to navigate along a pre-defined sequence of waypoints.

The GPS 65 route capability allows you to create and store ten routes, numbered 0 through 9, containing up to 20 waypoints each. Routes 1 to 9, the storage routes, can be activated to travel either in the order you defined the waypoints or in reverse order. Route 0, the active route, is the route you are navigating. The waypoint toward which you are navigating is called the "active to" waypoint. The waypoint immediately behind you is called the "active from" waypoint. The line that connects the "active from" and "active to" waypoints is called the "active leg."

The GPS 65 features automatic leg selection which will select the route segment closest to your position as the active leg. The GPS 65 also features automatic leg sequencing. As you pass a waypoint in the route, the unit will automatically select the next waypoint as the "active to" waypoint.

There are 3 route pages in the GPS 65. The softkeys at the bottom of each page allow cycling through each page: RTE (route definition), ACTV (active route), and LIST (route list).

4.2 CREATING AND COPYING A ROUTE

The Route Definition page allows you to create, change, review, copy, and activate routes. Remember that route 0 is always the active route. If you create a route in route 0, you should copy it into an empty storage route (1-9). When you activate a storage route 1-9, it will be copied to route 0 for activation.

Route Definition

Route #	Field	Route Action Field	
Rte	0	Activate?	
	GARMIN		
	KVAP	178°	1.83
	CLIFF	263°	3.51
	RZRBC	330°	5.05
	MIDAMR	042°	5.00
	LIST	ACTV	RTE

Waypoint List

Desired Track

Leg Distance

Press the RTE key. If you are not already on the Route Definition Page, press the RTE softkey. On the route number field, you may choose between routes 0 through 9 with CLR. Next to this is another cyclic field which allows you to activate the route, clear the route, copy the route to another location, or invert the order of the waypoints in a route and activate it. The arrow keys allow you to scroll through the list of waypoints in a route.

To Create a Route...

Route #	Field	Route Action Field	
Rte	0	Activate?	

	LIST	ACTV	RTE

- Move the cursor to the route number field and press CLR until you find an empty route.
- Scroll to the first blank waypoint name field and type in a waypoint you wish to put in the route.
- Press ENT.
- Repeat this process for each waypoint you want to add, up to a total of 20.

Rte#0	>Copy To<	▶	—
GARMIN	---	°	---
KVAP	178°		1.83
CLIFF	263°		3.51
RZRBC	330°		5.05
MIDAMR	042°		5.00
LIST		ACTU	RTE

To copy a route...

- Select the Route Definition Page (RTE).
- Highlight the route number field and select the route number to copy from with CLR.
- Highlight the route action field with the arrow keys and press CLR until ">Copy To>" is displayed.
- A third field now appears in the top right corner. Highlight this field and select the destination route number with CLR.
- Press ENT. The route is now copied.

4.3 ACTIVATING ROUTES

Routes are activated on the Route Definition Page also. You may activate any route in the displayed order, or in reverse order. (NOTE: Remember, when a new route is activated, the previous contents of route 0 will be overwritten. If you wish to save route 0, be sure to copy it to an empty route first.)

Rte#1	>Activate?<		
GARMIN	---	°	---
KVAP	178°		1.83
CLIFF	263°		3.51
RZRBC	330°		5.05
MIDAMR	042°		5.00
LIST		ACTU	RTE

To activate a route...

- Select the Route Definition Page (RTE).
- Highlight the route number field and select the route number to activate with CLR.
- Highlight the route action field, and with CLR select ">Activate?".
- Press ENT to activate the route.

Rte#1	>Invert?<		
GARMIN	---	°	---
KVAP	178°		1.83
CLIFF	263°		3.51
RZRBC	330°		5.05
MIDAMR	042°		5.00
LIST		ACTU	RTE

To invert a route...

- Follow the same steps as above for activating a route, but select, ">Invert?" at the route action field.
- Press ENT to activate the route in an inverted order.

4.4 EDITING ROUTES

Rte▶1 ▶Activate?		
	---	* --
GARMIN		
KVAP	178°	1.83
CLIFF	263°	3.51
RZRBC	330°	5.05
MIDAMR	042°	5.00
LIST	ACTU	RTE

Rte▶1 ▶Activate?		
	---	* --
GARMIN		
MIDAMR	275°	89.0
KVAP	094°	89.3
CLIFF	263°	3.51
RZRBC	330°	5.05
LIST	ACTU	RTE

- If you attempt to add a waypoint to a route that already contains 20 waypoints, you will be informed with the message, "Route is Full".

NOTE: You may also edit a route from the Active Route Page (see Section 4.6).

4.5 DELETING ROUTES

You may delete an unwanted route from the Route Definition Page.

Rte▶0 Delete?		
	---	* --
GARMIN		
KVAP	178°	1.83
CLIFF	263°	3.51
RZRBC	330°	5.05
MIDAMR	042°	5.00
LIST	ACTU	RTE

To Edit an Existing Route...

- Select the Route Definition Page (RTE).
- Highlight the route number field and select the route you wish to edit.
- To insert a waypoint into the route, highlight the waypoint you want to place the new waypoint in front of. Type in the new waypoint name. Press ENT. The new waypoint is added to the route.
- To delete a waypoint from the route, highlight the waypoint you wish to delete. Press CLR and ENT.

To delete a route...

- Highlight the route number field and select the route you wish to delete with CLR.
- Highlight the route action field and select ">Clear?" with the CLR key.
- Press ENT to delete the route.

4.6 ACTIVE ROUTE

The screenshot shows a rectangular display area with the following content:

RZRBCK → MIDAMR		
	RNG	*ETE
MIDAMR	2.76	1:33
GARMIN	8.20	4:38
-----	---	---
-----	---	---
ATE	LIST	ACTV

Labels and their corresponding elements:

- Active Leg:** Points to the top line "RZRBCK → MIDAMR".
- Waypoint List:** Points to the first column of the table.
- Range:** Points to the "RNG" header.
- Cyclic Column:** Points to the "*ETE" header.

Legend for Cyclic Column:

- ETE
- ETA
- DTK

The Active Route Page displays the waypoints of the active route starting with the “active from” and “active to” waypoints on the top line. Press the ACTV softkey to select this page.

The Waypoint List displays route waypoints starting with the “active to” waypoint. For each waypoint, additional information is available. The first column displays Range (RNG). The second column is a cyclic field that displays Estimated Time Enroute (ETE, in hours/minutes or minutes/seconds, as appropriate), Estimated Time of Arrival (ETA), or Desired Track (DTK). You may scroll through the waypoint list with the arrow keys.

To edit the active route...

- To insert a waypoint, highlight the waypoint you want to place the new waypoint in front of. Type in the new waypoint name. Press ENT. The new waypoint is added to the route.
- To delete a waypoint, highlight the waypoint you wish to delete. Press CLR and ENT.

4.7 ROUTE LIST

The Route List Page displays a list of all routes currently stored in memory. Press the LIST softkey to select this page. The Route List Page displays the route numbers (far left), beginning waypoint, and final destination waypoint. You may also activate or delete a route from the Route List Page.

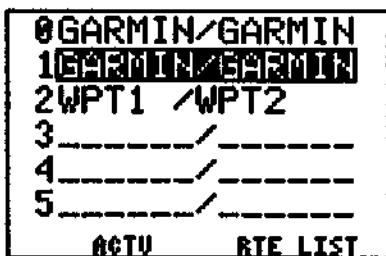

To Activate a Route...

- Highlight the route you wish to activate with the arrow keys.
- Press ENT. The Route Definition Page is displayed with the ">Activate?" action highlighted.
- Press ENT to Activate the route.

To Delete a Route...

- Highlight the route you wish to delete with the arrow keys. Press CLR. The Route Definition Page is displayed with the ">Clear?" action highlighted.
- Press ENT to delete the route.

Building Routes with AutoStore...

The GPS 65's AutoStore™ feature is the quickest and easiest way to build a route as you go. With autostore, each time you turn on a new track, pass a significant landmark, or reach some location of interest, you can save the location and create a route at the same time. Each autostore waypoint can be added to the same route as you are traveling.

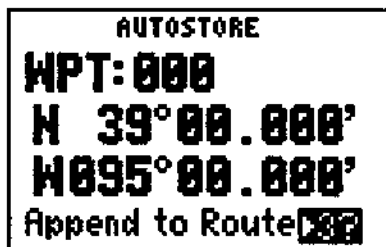

- With the unit operating in 2D or 3D Navigation mode, press the AUTOSTO key to save your starting location.
- At this point, you may change the AutoStore name, if you wish (see Section 3.6).

- Select an empty route to store the waypoint into by highlighting the "Append to Route >?" field and pressing CLR until the desired route number is displayed.
- Press ENT to add the waypoint to the selected route.
- Repeat these steps each time you arrive at a location you wish to add to the route, up to a total of 20 waypoints per route.

CHAPTER 5

ADVANCED WAYPOINT FEATURES

5.1 NEAREST WAYPOINTS

An important feature of the GPS 65 is the ability to display up to nine nearest waypoints, within 100 nautical miles of your present position. In an emergency, you may use the nearest waypoint feature to find the closest point of safety in your area. As was discussed in Section 3.4, you may access the waypoint pages by pressing the WPT key.

1	MOB	277° 0.8 _m
2	RZRBC	267° 3.2 _m
3	MIDAMR	003° 3.5 _m
4	GARMIN	101° 3.7 _m
5	CLIFF	188° 4.6 _m
6	KVAP	146° 5.0 _m
WPT LIST FROM NRST		

If the Nearest Waypoint Page is not currently displayed, press the NRST softkey. This page displays the waypoint names including bearing and range from present position. You can scroll through the waypoints listed by using the arrow keys.

To GOTO a Nearest Waypoint...

- Move the cursor to the desired waypoint name with the arrow keys.
- Press GOTO and ENT.

5.2 PROXIMITY WAYPOINTS

The Proximity Waypoint Page allows you to define an alarm circle around a waypoint. This feature is useful in defining an area around a rock, reef, or restricted waters. When you approach one of these waypoints, the GPS 65 will notify you with an alarm tone and the message, "Prox Alarm-[waypoint name]," if you enter the alarm circle.

1	GARMIN	1.0 _m
2	RZRBC	0.5 _m
3	WLDCAT	20.0 _m
4	-----	---.0 _m
5	-----	---.0 _m
6	-----	---.0 _m
NRST WPT LIST PROX		

The GPS 65 allows you to define a maximum of nine proximity waypoints. Scroll through the proximity waypoint list using the arrow keys.

To set a proximity waypoint...

- Select the Proximity Waypoint Page with the PROX softkey.
- Select a blank waypoint name field with the arrow keys.
- Enter the waypoint name. (NOTE: If neither the waypoint name nor the location exists in memory, the Waypoint Definition Page will be displayed. You must then enter the waypoint location. See Section 3.4 to create a waypoint.)
- Press ENT.
- Enter the proximity alarm distance.
- Press ENT to enable proximity alarm.

If the newly created proximity alarm circle overlaps with an existing proximity alarm circle, you will be informed of the overlap with the message "Proximity Overlap". As long as the overlap remains, this message will be displayed each time the GPS 65 is turned on. (WARNING: If you enter the overlap area, the unit will only inform you of the nearest waypoint.)

5.3 REFERENCE WAYPOINTS

In section 3.4, we discussed creation of waypoints by entering the latitude and longitude position. Another way to create a waypoint is by referencing an existing waypoint. By indicating the bearing and range from a reference waypoint, the GPS 65 is able to compute a latitude and longitude location for the new waypoint.

WPT: KMCI
N 39° 17.960'
W 094° 43.080'
*REF: GARMIN
BRG: 000° RNG: 21.00
WPT

To create a waypoint by referencing another...

- Select the Waypoint Definition Page with the WPT softkey.
- Highlight the WPT name field and enter the new waypoint name.
- Press ENT.
- Highlight the ">Ref:" field and enter the existing waypoint that will be used as reference. (If the reference field is not currently shown, highlight that cyclic field and press CLR until it is displayed.)
- Press ENT.

- Enter the bearing and distance from the existing waypoint to the new waypoint.
- Press ENT. A latitude and longitude location for the new waypoint should now be displayed.

5.4 WAYPOINT SCANNING

Throughout this manual, each time we have encountered a waypoint name field, we have entered the waypoint name with the alphanumeric keys. An alternative is to use the waypoint scanning feature.

To Scan for a Waypoint...

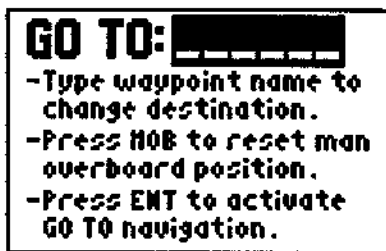

- As an example, use the GOTO waypoint field. Press GOTO.
- The waypoint name field is highlighted and may be blank or may already show a GOTO destination. If the waypoint name field is not blank, press CLR.

- Press WPT. A waypoint name is now displayed.
- Scan for the desired waypoint with the arrow keys. (NOTE: As you are scanning, up to nine nearest waypoints will be shown first; followed by the entire list in numeric and alphabetical order.)

To limit the scanning range, you may specify the first letter(s) or number(s) of the waypoint name.

To Perform a Limited Scan...

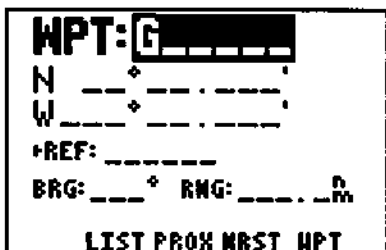

- For this example, select the Waypoint Definition Page with WPT and the WPT softkey, if needed.
- Highlight the waypoint name field with the arrow keys.
- If this field is not blank, press CLR.

- Enter the first character of the waypoint name. For this example, enter the letter "G".
- Press WPT. Use the arrow keys to scan through all waypoints that begin with the letter "G".

CHAPTER 6

AUXILIARY FUNCTIONS



The GPS 65's auxiliary pages allow you to do utility and setup functions to customize your unit. The 11 auxiliary pages are accessible from the auxiliary menu (see Section 3.2) by highlighting the page you want and pressing ENT. The softkeys allow changing to previous (PREV) and next (NEXT) pages. The AUX softkey takes you back to the Auxiliary Menu Page.

6.1 OPERATING MODE AND FILTERS

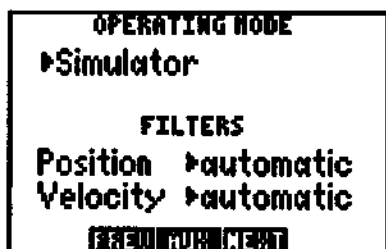

From this page, you may change between various operating modes by highlighting the "OPERATING MODE" field and pressing CLR. You may select simulator mode, normal mode, or battery saver mode. (See Section 2.7 for a description of each mode.)

Also from this page, the position and velocity filters may be changed. Changing the filter settings will alter the GPS 65's response time to changes in track or ground speed. To change the filter settings, highlight the appropriate field and cycle through the filter settings (automatic, fast, medium, and slow) with CLR. The "Fast" setting will provide instantaneous response (three seconds maximum response time) to changing conditions. The "Medium" (approximately 20 seconds) or "Slow" (approximately 120 seconds) settings may be more desirable for slow speed operation where frequent ground track changes will occur (e.g. sailing or hiking). It is highly recommended that you select the "Automatic" setting for most applications.

6.2 PLOTTING SETUP

```

PLOTTING
Orientation▶North up
▶Route and Track
▶Interval: 00:00:30
Track▶wrap Clear?
Memory Used    0%
PREV NEXT

```

The Plotting Setup Page is used to configure the Plot Page and select the types of information that will be displayed. The first cyclic field defines the orientation of the plot map. The top of the plot map may be North (North Up), the direction of your current ground track (TRK Up), or the direction of the active leg

of a route (DTK Up). To select the desired option, highlight this field and press CLR. Your present position and nearby waypoints are displayed on the plot map at all times. The second cyclic field determines what additional information will be displayed on the plot map. You may display the active route and a stored ground track showing where you have been, only the active route, only the ground track, or neither.

The ground track is stored at a frequency that you can define either by: Time "Interval", "Resolution", or "Distance". Select the desired frequency unit by highlighting this field and pressing CLR.

To store the Ground Track at selected time Intervals...

- Highlight the storage frequency field (third line) and select "Interval" with CLR.
- Press ENT.
- Enter the time interval between stored positions starting with hours, then minutes, then seconds. Press ENT after entering data in each numeric field.

To store the Ground Track by Distance...

- Highlight the storage frequency field and select "Distance" with CLR.
- Press ENT.
- Enter the distance, and press ENT. When your position moves this distance in any direction, a new position is added to the stored ground track. NOTE: "Distance" storage may be preferable to "Resolution" storage if the ground track will include a large number of turns.

If the planned course will be primarily straight line travel, you should select "Resolution" storage. In this application, considerably less memory is used for the same distance traveled.

To store the Ground Track by Resolution...

- Highlight the storage frequency field and select "Resolution" with CLR.
- Press ENT.
- Enter the resolution range, and press ENT. When your position moves this defined range off a projected course line, a new position is added to the stored ground track.

The track storing function may be turned on and off by highlighting the "Track>" field and pressing CLR. From this same field, the track may be set to "wrap" around through available memory (deleting the oldest track information and using the memory to store the new track position). The amount of memory, used at any given moment, is shown on the bottom line. When available memory is filled or the track is no longer needed, it may be cleared by highlighting "Clear?" and pressing ENT.

6.3 UNITS/HEADING SETUP

<p>UNITS / HEADING</p> <p>Posn ▶hddd°mm.mmm'</p> <p>Nav ▶nautical</p> <p>Hdg ▶auto mag var</p> <p>E004°</p> <p>PREV PAGE NEXT</p>

The Units/Heading Page is used to select the units to display for position, distance, speed and heading information. Select the desired position units by highlighting the "POSN" field and pressing CLR. You may choose between degrees only (hddd.dddd°);

degrees and minutes (hddd°mm.mmm'); degrees, minutes and seconds (hddd°mm'ss.s"); UTM/UPS; or various regional grid coordinates.

Select the desired distance and speed units by highlighting the "NAV" field and pressing CLR. You may choose between nautical (nautical miles/knots/feet), statute (statute miles/miles per hour/feet), or metric (kilometers/kilometers per hour/meters) units.

Heading information can be displayed referencing magnetic north (automatically calculated or user-defined), referencing true north or referencing calculated grid headings. Select the desired heading reference by highlighting the "HDG" field and pressing CLR. When the "Auto Mag Var[iation]" option is selected, heading information will

reference the automatically calculated magnetic variation shown. For most applications, the "Auto Mag" feature will provide accurate heading information. If the auto-magnetic variation is not correct, you may define the magnetic variation by selecting "User Mag Var". If the "User Mag Var" option is selected, the magnetic variation is then entered.

To enter a user-defined magnetic variation...

- Highlight the "HDG" field and select "User Mag Var" with CLR.
- Press ENT.
- The variation direction is highlighted. To change the direction, press CLR.
- Press ENT.
- Enter the variation degrees and press ENT.

6.4 ALARMS AND CDI SETUP

ALARMS / CDI
Anchor: 0.10m ▶on
Arrival: 0.5m ▶on
Clock: 00:00 ▶off
CDI Scale ▶1.00
Steer To ▶center
FREQUENCY

From the Alarms/CDI Page, you may define three alarms (and turn them on or off) and configure the graphic CDI to your preference. Alarms are available for anchor drift, arrival at a destination waypoint, and an alarm clock.

To set the anchor alarm...

- Highlight the anchor alarm distance and enter the maximum allowable drift. **CAUTION:** Setting the anchor alarm to its smallest value (.01 unit) may result in a false alarm. Please note that under certain circumstances (below average satellite geometry, degraded reception, etc.) the position error of the GPS 65 may be greater than the lowest scale settings available for this alarm.
- Press ENT.
- The on/off cyclic field is highlighted. If the alarm is not turned on, press CLR.

To set the arrival alarm...

- Highlight the arrival alarm distance and enter the distance from a destination at which you want the alarm to sound.

- Press ENT.
- The on/off cyclic field is highlighted. If the alarm is not turned on, press CLR.

To set the alarm clock...

- Highlight the alarm clock time and enter the desired alarm time. NOTE: The alarm time may be either UTC or local time depending on the setting on the Date/Time Page. (See Section 6.5.)
- Press ENT.
- The on and off cyclic field is highlighted. If the alarm is not turned on, press CLR.

The graphic CDI may be configured to the desired scale and steering orientation. Scale settings of ± 1.0 , $.50$, 1.00 , 5.00 , 10.0 , or 50.0 units (nautical miles, statute miles, or kilometers) are available. The scale setting represents the distance from center of the CDI to either end. You may change the scale setting by highlighting the "CDI Scale" field and pressing CLR. The CDI "Steer To" orientation determines how you interpret the "D-Bar" when it moves. You may select "Steer to >Center" or "Steer to >D-Bar" by highlighting that field and pressing CLR. A "Steer to Center" orientation, in effect, displays your position as the "D-Bar" and the center of CDI is the desired track. Thus, when you are off course, you would steer towards the center of the scale. A "Steer to D-Bar" orientation is just the opposite. The "D-Bar" represents the desired track and the center of the scale represents your position. When you are off course, you then steer towards the "D-Bar".

6.5 DATE/TIME

<p>DATE / TIME 09-DEC-92 07:52:42 Local Ofst: -6:00 Display Local time TIMER ▶count up: 01:37:45 PREVIOUS NEXT</p>

The Date/Time Page displays the UTC (Coordinated Universal Time or Greenwich Mean Time) date and time. The local offset or time difference is shown on the next line. For time zones west of the UTC zone, enter a negative offset. (The minus sign is on the "9" key.) Appendix E contains a list of time offsets.

The cyclic field for "Display" options determines which time, UTC or Local, will be displayed on other GPS 65 pages. To change this option, highlight this field and press CLR.

The timer field can be selected as "Count Up" or "Count Down" by highlighting and pressing CLR. To clear the count up timer, highlight each time field, press CLR, then ENT.

To set the count down timer, enter the hours, minutes, then seconds to count down from. The "Timer Expired" message will be displayed when the timer reaches zero.

6.6 AUDIO AND DISPLAY SETUP



From the Audio and Display Page, you can turn the message and/or keypad tones on and off, change the display contrast, and change the timeout for the display backlighting. Select the desired tone option by highlighting the "Tone>" field and pressing CLR.

To change the display contrast...

- Highlight "Change Contrast?" and press ENT.
- The contrast bar is highlighted. Press the left or right arrow key to change the contrast level.
- When the desired contrast level is reached, press ENT.

The Backlighting Timeout determines the length of time the display and keypad backlighting will remain on. If no keys are pressed for the specified time, the backlighting will automatically shut off. Set the timeout interval by highlighting that field, entering the desired timeout and pressing ENT.

6.7 INTERFACE SETUP



From the Interface Page, you may select the input or output format needed to connect your GPS 65 to other equipment: plotter, autopilot, another GPS 65, a PC, etc. You may select no input/output (NONE/NONE), NMEA output, GARMIN input/output, or RTCM input by highlighting the cyclic field and pressing CLR. When the NMEA

output is selected, a second cyclic field appears. From this second field, you may select the desired NMEA format: NMEA 0180, NMEA 0182 or NMEA 0183.

A second cyclic field also appears when the GARMIN input/output is selected. The GARMIN option allows you to exchange data such as waypoints, routes, track logs and satellite almanac data with another GPS 65 or with a PC-compatible computer. You may select between acting as a HOST to data exchanges, REQUESTing data, or SENDING data by highlighting the cyclic field and pressing CLR. When the HOST option is selected, all interface operations are controlled by another GPS 65 or PC-compatible computer. When the REQUEST or SEND options are selected, the GPS 65 will control the data exchange. With the REQUEST or SEND options, a third cyclic field appears where you may define the type of data to be exchanged: routes, track log, waypoints, almanac, or proximity waypoints. Select the desired type of data by highlighting this field and pressing CLR. Press ENT to begin the data transfer. During the data transfer process, the number of data packets being exchanged will be displayed. Note: When exchanging data between two GPS 65s, one should be set to HOST and the second should be set to the desired data transfer option (REQUEST or SEND).

The GPS 65 can use Differential GPS (DGPS) corrections in RTCM SC-104 version 2.0 format. DGPS corrections in this format can be received from an external device (capable of output in 6 of 8 byte format as specified by RTCM SC-104, version 2.0) by connecting the device to the input port on the back of the GPS 65 and selecting an RTCM input interface mode. Two RTCM input modes are available, one which allows no output and another which allows NMEA output in 0180, 0182, or 0183 format.

6.8 MAP DATUM SELECTION

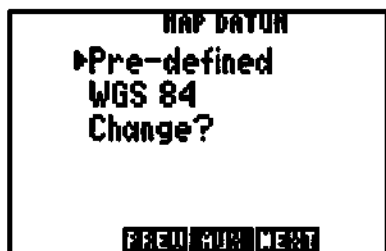

Select the desired map datum reference from the Map Datum Page. You may choose from 102 pre-defined map datums, or you may define your own. If the map/chart you are using specifies a reference datum, select that datum on your GPS 65. If the map/chart does not

specify a reference datum, you may select each datum applicable to your region until you find the datum that provides the best positioning at a known point. NOTE: The GPS 65 is shipped from the factory with the WGS 84 datum selected.

To change the pre-defined datum...

- Highlight the "Change?" field and press ENT.
- With the arrow keys, find the desired datum and highlight it.
- Press ENT. The new datum is selected

MAP DATUM		
▶User-defined		
dX	0 ^F	0 ^F
dZ	0 ^F	
dA	0.00 ^F	
dF	0.00000000e-04	
FREE PROMPT		

The user-defined datum option allows you to custom-tailor a datum reference from which all position coordinates are calculated. All entries are defined as differences from the WGS 84 standard datum. CAUTION: Selection and use of the user datum function is for individuals experienced in the use of map datums. If the pre-defined map datums do not

correspond to the chart you are using and you are unsure of the correct entries required to correspond to that chart, contact the chart manufacturer. Incorrect entries for a user-defined datum may result in substantial position errors.

6.9 BEACON RECEIVER SETUP

BEACON RECEIVER	
Tuned To:	304.0 kHz
Bit Rate	▶100 bps
Distance	__ _n
SNR	__ dB Tuning
View Beacon Log?	
FREE PROMPT	

The Beacon Receiver Setup Page allows you to control a GARMIN Beacon Receiver for Differential GPS (DGPS) position corrections. Before the beacon receiver can be controlled by the GPS 65, it must be connected to the I/O port on the back of the unit and the "RTCM/NMEA 0183" mode must be selected on the Interface Setup Page. If this

interface mode is not selected, the GPS 65 will only display the message "No RTCM/NMEA 0183 interface selected" on the Beacon Receiver Setup Page. Once the correct interface is chosen, the Beacon Receiver Setup Page will display as shown above.

The "Tuned To:" field is the frequency in kHz to which the beacon receiver is currently tuned or is attempting to tune. Below this field is a bit rate cyclic field which allows you to choose between bit rates of 25, 50, 100, and 200 bps by pressing the "CLR" key which the "Bit Rate" field is highlighted. When you first select the Beacon Receiver Setup Page from the Auxiliary Menu, (after selecting an RTCM/NMEA 0183 input/output interface mode), the GPS 65 will automatically try to tune the

last frequency and bit rate which you selected (or the default frequency of 304.0 kHz and bit rate of 100 bps if no previous beacon has been tuned). You may enter your own frequency (between 283.5 kHz and 325.0 kHz in 0.5 kHz increments) and bit rate if you desire. A message of "Tuning" will then be displayed near the bottom of the page, directly after the "SNR" field. If the "Tuned To:" frequency cannot be received within the timeout period, the unit will stop trying to tune, the "Tuned To:" field will display all blanks, and a status message of "No Status" will display after the "SNR" (signal-to-noise) field. You must provide the unit with another frequency and bit rate before it will attempt to tune again. The last field on the Beacon Receiver Setup Page is the "View Beacon Log?" confirmation field. Pressing "ENT" on this field will display the Beacon Log Page.

Freq	Stn ID	Dist
304.0	0001	4.0 ⁿ
----	----	-. ⁿ
----	----	-. ⁿ
----	----	-. ⁿ
----	----	-. ⁿ

Press CLR to cancel

The Beacon Log Page displays the last five frequencies tuned by the user, or the default frequency if no user frequencies have been tuned. The most recently tuned frequency is at the top of the list. If the tuned frequency station identifier and position were available when the frequency was last tuned, the list will also display the "Stn ID" number

and the distance to the transmitting beacon. You can tune any frequency in this list by pressing the left or right arrow key until the desired frequency is highlighted and then press "ENT". The display will immediately return to the Beacon Receiver Setup Page with the selected frequency from the Beacon Log Page as the "Tuned To:" frequency, and the bit rate as the last bit rate used with the selected frequency. If you view the Beacon Log Page and decide that you do not want to tune any of the frequencies in the log, simply press "CLR" on any field to return to the Beacon Receiver Setup Page.

6.10 SUNRISE/SUNSET PLANNING

SUNRISE / SUNSET	
WPT:	GARMIN
Date:	10-DEC-92
Rise	07:26:22
Set	16:56:58
PREVIOUS NEXT	

The Sunrise/Sunset Page allows you to calculate the sunrise and sunset times for a given waypoint location on a selected date (from 1990 through 2089).

To calculate the sunrise/sunset times for a waypoint...

- Highlight the waypoint name field and enter the desired waypoint name.
- Press ENT
- The date field is highlighted. Enter the day, then month, then year to calculate the sunrise/sunset times. Press ENT on each alphanumeric field.
- Once the year is selected and ENT is pressed, the calculated sunrise and sunset times will be shown. Please note that the times shown will be either UTC or local depending on the selection made on the Date/Time Page. (See Section 6.5.)

6.11 TRIP AND FUEL PLANNING

```
TRIP & FUEL PLANNING
▶RTE ▶0 Leg ▶4
RZRBCK → MIDAMR
SPD: 0.0% Flow: 0
DTK 042* REQ 0.0
RNG 5.00% ETE 0:00
PREV AUX NEXT
```

The Trip and Fuel Planning Page allows you to calculate time and fuel requirements between any two waypoints or for any programmed route. On the first cyclic field, you will choose between waypoint (WPT) or route (RTE) planning by highlighting and pressing CLR. If

route planning is selected, you would then select the desired route number and the portion of the route (a given leg or all of the route) to calculate for.

The final step is to enter speed and fuel flow rates. The GPS 65 will then calculate the desired track (DTK), fuel requirements (REQ), range (RNG), and estimated time enroute (ETE).

To perform a Trip and Fuel Plan, waypoint to waypoint...

```
TRIP & FUEL PLANNING
▶RTE ▶0 Leg 000
GARMIN / GARMIN
SPD: 25% Flow: 7
DTK ___* REQ 6.3
RNG 22.7% ETE 54:22
PREV AUX NEXT
```

- Highlight the first cyclic field (top left), and press CLR to select "WPTS".
- Highlight the waypoint name field (second line), and enter the first waypoint name followed by ENT.
- The second waypoint name field is now highlighted. Enter the second waypoint name followed by ENT.

- The speed (SPD) field is highlighted. Enter the intended speed, and press ENT.
- The fuel flow (Flow) field is highlighted. Enter the estimated fuel flow followed by ENT.
- The GPS 65 will now display the calculated figures.

To perform a Trip and Fuel Plan for a route...

```

TRIP & FUEL PLANNING
▶WPTS:
  00000 → GARMIN
SPD: 10+ Flow: 7
DTK 110+ REQ 4.4
RNG 6.31h ETE 37:53
PREV AUX NEXT
  
```

- Highlight the first cyclic field (top left), and select "RTE" with CLR.
- Highlight the next cyclic field and select the desired route number by pressing CLR.

- Highlight the "Leg>" field and select the desired leg, or select "All" for the entire route, using CLR.
- Highlight the "SPD:" field and enter the intended speed, followed by ENT.
- Highlight the "Flow:" field and enter the estimated fuel flow followed by ENT.
- The GPS 65 will now display the calculated figures.

6.12 MESSAGES

```

MESSAGES
Approaching GARMIN
Timer Expired
  
```

You may recall from Section 2.6 that some messages will remain on the Message Page after being viewed. When this occurs, the "MSG" annunciator remains on (but does not flash) in the lower left corner. To view these messages, select "Messages" from the Auxiliary Page. See Appendix A for a description of available messages.

APPENDIX A

MESSAGES

The GPS 65 uses the Message Page to communicate important information to you. Some messages are advisory in nature, others are warnings that may require your intervention. This appendix provides a complete list of messages and their meanings. Please pay careful attention to all messages.

Alarm Clock - The alarm time for the alarm clock has been reached.

Anchor Drag Alarm - Your craft has drifted outside the anchor drag radius set on the Alarm Page.

Approaching ____ - You are less than one minute from reaching the indicated waypoint.

Arrival At ____ - Your craft has entered the arrival alarm circle for the indicated destination waypoint.

Can't Chng Activ WPT - An attempt has been made to modify the position of the "active to" or "active from" waypoint. The GPS 65 will not allow the modifications.

Degraded Accuracy - The accuracy of the GPS 65 position is degraded beyond 500 meters due to satellite geometry or data quality. Additional cross checking should be performed by the user to verify the integrity of the GPS position.

Memory Battery Low - The battery that sustains user memory is low and should be replaced by an authorized GARMIN service center as soon as possible. Failure to do so may result in loss of stored data, including all waypoints and routes.

No DGPS Position - Not enough DGPS data is available to compute a corrected position.

No RTCM Input - A beacon receiver is improperly connected to the input port on the back of the GPS 65, a connected beacon receiver is not transmitting in an RTCM SC-104 version 2.0 format, or the baud rates do not match between the GPS 65 and the beacon receiver.

Osc Needs Adjustment - The GPS 65 has detected excessive drift in its internal crystal oscillator which may result in longer acquisition time. The unit should be taken to an authorized GARMIN service center as soon as possible.

Poor GPS Coverage - The GPS 65 cannot acquire sufficient satellites necessary to provide navigation.

Pwr Down and Re-init - The GPS 65 is unable to compute a position due to abnormal satellite conditions. Power down the unit and verify that the position on the Position Page is within a few degrees of your actual position.

Proximity Alarm - Your craft has penetrated the alarm circle of a proximity waypoint.

Proximity List Full - An attempt to upload more than nine proximity waypoints has been made.

Proximity Overlap ____ - The circles defined by two proximity waypoints overlay. When entering the area of the overlap, the GPS 75 will alert you of the closest proximity waypoint, but not both. You should be certain this condition is desirable.

Proximity Waypoint - An attempt has been made to delete a waypoint for which a proximity alarm has been defined. You must remove the waypoint from the proximity list before the waypoint can be deleted.

Received Invalid Wpt - A waypoint was received in an upload/transfer operation that has an invalid identifier or position.

Receiver Failed - The GPS 65 has detected a failure in the receiver hardware. If the message persists, the GPS 65 is unusable and should be taken to an authorized GARMIN service center.

ROM Failed - The GPS 65 has detected a failure in its permanent memory. If this message occurs, the unit is unusable and should be taken to an authorized GARMIN service center.

Route is Full - An attempt has been made to add more than 20 waypoints to a route. The GPS 65 will not allow more than 20 waypoints per route.

Route Not Empty - An attempt has been made to copy a route to a non-empty route. The GPS 65 will not allow you to copy a route to a non-empty route.

Route Waypoint - An attempt has been made to delete a waypoint which is a member of one or more routes. You must remove the waypoint from all routes before the waypoint can be deleted.

Route Wpt Deleted - A waypoint in a transmitted route does not exist in the database and has been deleted from the route.

RTCM Input Failed - RTCM data was being received but the connection has been lost.

Searching the Sky - The GPS 65 is in the search-the-sky mode. Allow the unit to complete its data collection before turning it off. This process takes approximately 15 minutes.

Stored Data Lost - Stored user data, including waypoints, routes, and satellite orbital data has been lost due to a low memory battery.

Timer Expired - The count down timer has expired.

Track Memory Full - The track memory is full. Go to the Plotting Setup Page and clear the memory.

WPT Exists ____ - You have entered a waypoint name on the AutoStore™ Page that already exists in memory. Enter a waypoint name that does not exist.

WPT Memory Full - The waypoint memory is full. You should delete unused waypoints to make room for new waypoints.

WPT/RTE RX Started - The GPS 65 has received the first data transmission in a waypoint/route upload or transfer operation.

WPT/RTE TX Complete - The GPS 65 has transmitted the last information in a waypoint/route transfer operation.

APPENDIX B

GLOSSARY AND NAVIGATION TERMS

B.1 DEFINITIONS

This section provides an illustration of and definitions for the terms used in this manual.

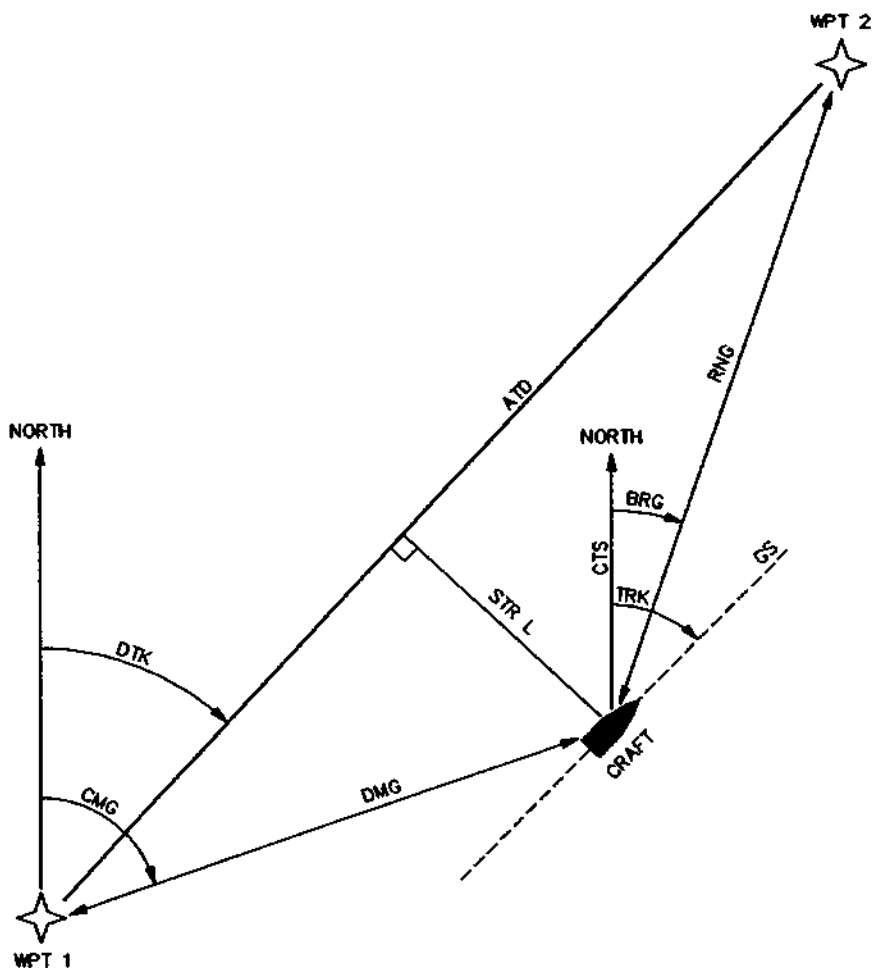

Velocity/time terms:

- GS** Ground speed. GS is the speed measured relative to a ground position; also known as velocity over ground (VOG).
- VMG** Velocity made good. VMG is velocity in the direction of the desired course. It is the speed at which you are closing on the “active to” waypoint.
- ETA** Estimated time of arrival. ETA is the estimated time you will reach the “active to” waypoint based on VMG. This time is selectable as either UTC or local.
- ETE** Estimated time enroute. ETE is the time it will take to reach the “active to” waypoint based on VMG.

Direction terms:

- DTK** Desired track. DTK is the course between the “from” and “to” waypoints.
- BRG** Bearing. BRG is the direction from your position to the “active to” waypoint.
- CTS** Course to steer. CTS is the recommended direction to steer in order to reduce cross track error and stay on course (see Section B.2 for an example using CTS).
- CMG** Course made good. CMG is the bearing from the “active from” waypoint to your position.
- TRK** Track. TRK is the direction of movement relative to a ground position.
- TRN** Turn instruction. TRN is the difference between BRG and TRK. “L” indicates you should turn to the left, “R” indicate you should turn to the right. The degrees indicate the angle you are off course.

Distance terms:

- RNG** Range. RNG is the great circle distance from your position to the “active to” waypoint.
- DMG** Distance made good. DMG is the distance from the “active from” waypoint to your position.
- XTK** Crosstrack. XTK is the cross track error, or distance that you are off course. If the crosstrack error exceeds the CDI scale

setting, the XTK distance will also be displayed on the appropriate side of the CDI.

ATD Along track distance. ATD is the along track distance to the “active to” waypoint. It is measured from the point on the course closest to your position.

Satellite terms:

DOP Dilution of precision. DOP is a measure of the satellite geometry quality and hence the relative accuracy of your position (one meaning the best and ten meaning poor).

EPE Estimated Position Error. EPE, which is computed using the satellite geometry (DOP), signal and data quality, receiver tracking status and other factors, is an overall measure of your position accuracy.

B.2 COURSE TO STEER (CTS)

Course To Steer is a GARMIN exclusive that recommends an optimal direction to steer that will guide you to the course and proceed efficiently along your route.

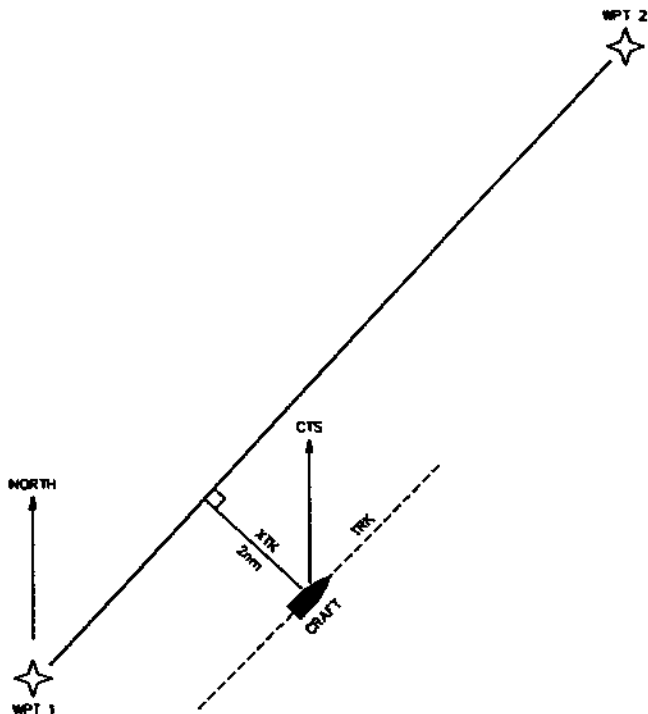

As an example, suppose you activate the route illustrated above. The GPS 75 chooses the closest leg with a desired track of 45 degrees but your position happens to be two nautical miles off course. The unit will automatically compute the optimal course to steer (which is due north in this example). Press the NAV key until the Nav Summary Page is displayed, then select "CTS" on line two. Using the CTS direction (000°), turn so that the track (TRK) and CTS direction match.

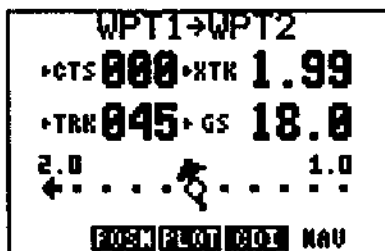

As you approach the course, CTS will slowly change and, once on course, will be identical to the desired track.

APPENDIX C

INSTALLATION AND MAINTENANCE

CAUTION: This equipment complies with FCC requirements. Only GARMIN manufactured accessories, which include the marine antenna and the power data cable, that couple to the receiver, shall be used. Changes or modifications not expressly approved by GARMIN could void the user's authority to operate the equipment.

C.1 SPECIFICATIONS

GPS 65 Specifications*

PHYSICAL

Case:	Waterproof
Size:	3.5" w x 5.1" h x 1.8" d (90mm x 129.5mm x 48mm)
Weight:	13 ounces (0.4 kg)

POWER

Input	12- or 24-volt DC with power cable (5-40 VDC) 115- or 230-volt AC with AC adaptor
Consumption	1.3 watts in Normal mode (without backlighting)

ENVIRONMENTAL

Temperature:	-15°C to +70°C (+5°F to +158°F) operating -40°C to +70°C (-40°F to +158°F) storage
Humidity:	95% non-condensing

PERFORMANCE

Receiver:	MultiTrac™, tracking up to 8 satellites
Acquisition Time: (typical)	2 minutes 2D 2.5 minutes 3D 15 seconds Warm Start (with ephemeris)
Accuracy:	Position: 15 meters (49 ft) RMS** Velocity: 0.1 knots RMS steady state
Dynamics:	90 knots velocity, 3g dynamics

INTERFACES

NMEA 0180

NMEA 0182

NMEA 0183 (Version 1.5; December 1987)

Approved sentences:

GPBWC, GPGLL, GPRMB, GPRMC, GPR00, GPWPL, GPXTE

Proprietary sentences:

PGRMZ - Altitude Sentence

PGRMM - Datum Sentence

Transmission rate:

GPBWC, GPVTG, GPGLL, GPRMB, GPRMC, GPXTE, and PGRMZ transmitted once every two seconds.

GPR00 transmitted once every (# of route waypoints + 1) * 2 seconds. e.g., if there are two route waypoints, this sentence will be transmitted once every six seconds.

GPWPL transmits all route waypoints in (# of route waypoints + 1) * 2 seconds. e.g., if there are two route waypoints, this sentence will be transmitted twice every six seconds.

RTCM SC-104 (version 2.0; January 1990)

Decoded Messages:

Type 1, Type 2, Type 3, and Type 9

6 of 8 byte format required

Communication Parameters:

300, 600, 1200, 2400, 4800, 9600 Baud 1 start/1 stop bit, 8 data bits, No Parity (Except that RTCM/NMEA 0180 and RTCM/NMEA 0182 interface selections require 1200 baud with odd Parity and RTCM/NMEA 0183 requires 4800 Baud.)

NOTES:

- * All specifications are subject to change without notice.**

- Connect the positive side of the alarm or relay to the positive side of the 5-40 volt DC power source.

The GPS 65 may be connected to other marine electronics such as an autopilot or plotter which use an NMEA 0180, NMEA 0182 or NMEA 0183 data interface. The unit can provide data for up to three NMEA "listeners" simultaneously. Refer to installation instructions of these devices for further information.

To connect the GPS 65 to an NMEA electronic device...

- Connect the BLUE harness lead to the NMEA "A" line of a two-wire, shielded cable.
- Connect the BLACK harness lead to the NMEA "B" line of the shielded cable.
- Connect the BLACK harness lead to the shield of the shielded cable. (The opposite end of the shield should not be grounded.)

To connect the GPS 65 to an electronic device supplying RTCM SC-104 data...

- Connect the WHITE harness lead to the output pin of the RTCM device.
- Connect the BLACK harness lead to the ground pin of the RTCM device
- If the GARMIN Beacon Receiver is used, the Beacon Receiver page (see Section 6.9) will tune the beacon frequency. Connect the BROWN harness lead to the input pin (RS-232 RXD) of the GARMIN Beacon Receiver.

Refer to the GARMIN Beacon Receiver Operating Manual for connection instructions.

C.3 INSTALLATION

The GPS 65 is equipped with a gimbal bracket for fixed installations. The GPS 65 can be mounted above dash, flush mounted, or overhead mounted as shown below.

Although the GPS 65 is waterproof and is designed to withstand the marine environment, it is recommended that it be mounted in a location which provides protection from sun and spray. Before permanent mounting, you may wish to apply power to the unit and look at the display in the desired mounting location to ensure you have the desired viewing angle.

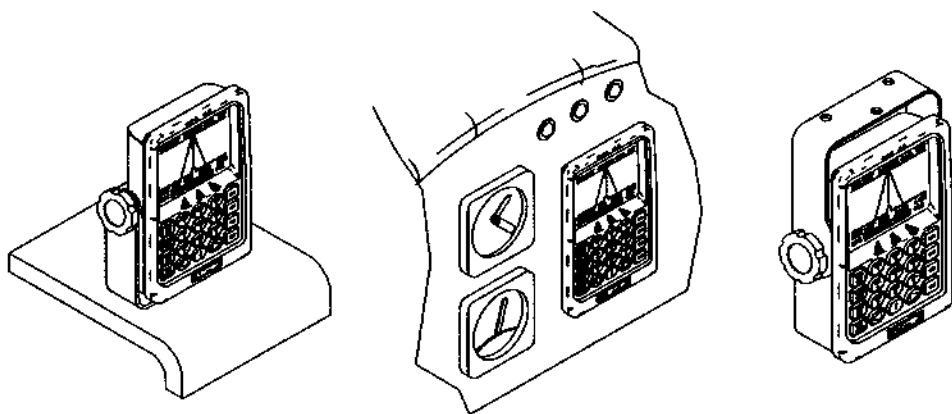

To install above dash or overhead...

The gimbal bracket can be mounted on a flat surface using appropriate screws (standard 3/16" or M6 screws are recommended; length must be selected depending on panel thickness). The GPS 65 can quickly be installed by sliding the threaded portion of the knobs into the slots in the gimbal bracket and tightening the knobs. The GPS 65 can easily be removed to prevent theft by loosening the knobs and sliding the unit out of the gimbal bracket as shown below.

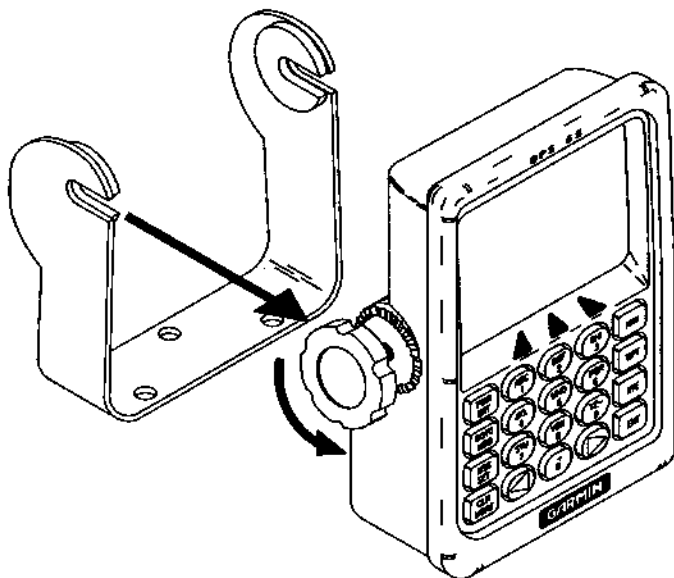

To flush mount...

- Make a rectangular cutout in the panel that is 84mm (3.30 inches) horizontally by 119.5mm (4.70 inches) vertically.
- Insert the GPS 65 into the cutout.
- Thread the knobs into the sides of the GPS 65 from behind the panel (do not fully tighten knobs).

- Slide the gimbal bracket slots over the threaded portion of the knobs so that the lobed section of the gimbal bracket faces downward as shown dashed in the figure below.

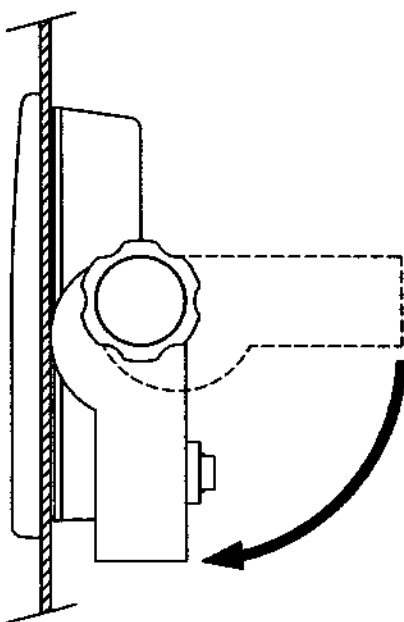

- Pull the gimbal bracket downward, clamping the GPS 65 tightly against the panel. Tighten the knobs securely.
- Connect the Power/Data Cable and the Antenna Cable.

The flush mount will accommodate panel thicknesses up to 7/16" thick. Thicker panels may require customizing the gimbal bracket or the use of standard M6 x 1mm x 12mm screws rather than the knobs supplied.

C.4 MAINTENANCE

The GPS 65 is constructed of high quality material and should not require user maintenance. Please refer any repairs to an authorized GARMIN service center. (The unit contains no user serviceable parts, do not attempt repairs yourself.)

Never allow gasoline or strong solvents to come into contact with your unit. Prolonged contact may damage the case and would not be covered by your warranty.

The waypoints, routes, custom settings, and other data stored in the GPS 65 are maintained by an internal battery. The internal memory battery should typically last three to five years. If the GPS 65 detects a low memory battery, you will be informed with the message "Memory Battery Low". You should return your unit to an authorized GARMIN service center as soon as possible for service. Failure to do so may result in loss of data each time you turn your unit off (indicated by the message "Stored Data Lost").

Your GPS 65 contains a highly accurate crystal oscillator which should provide many years of reliable operation. If the unit detects excessive oscillator drift, you will be informed with the message "OSC Needs Adjustment". You should return your unit to an authorized GARMIN service center as soon as possible. Failure to do so may result in degraded acquisition performance.

C.5 PRODUCT SUPPORT

Should you require additional assistance, please call our Product Support Department. Customers in the continental United States may use our toll free number: 1-800-800-1020. Customers outside the continental United States may call 1-913-599-1515.

APPENDIX D

MAP DATUMS

The following is a list of the GPS 65 map datum selections and the corresponding map datum name (including the area of application):

Adindan	Adindan - Ethiopia, Mali, Senegal, Sudan
Afgooye	Afgooye - Somalia
AIN EL ABD 1970	AIN EL ABD 1970 - Bahrain Island, Saudi Arabia
Anna 1 Astro 1965	Anna 1 Astro 1965 - Cocos Islands
ARC 1950	ARC 1950 - Botswana, Lesotho, Malawi, Swaziland, Zaire, Zambia, Zimbabwe
ARC 1960	ARC 1960 - Kenya, Tanzania
Ascension Island '58	Ascension Island '58 - Ascension Island
Astro B4 Sorol Atoll	Astro B4 Sorol Atoll - Tern Island
Astro Beacon "E"	Astro Beacon "E" - Iwo Jima Island
Astro Dos 71/4	Astro Dos 71/4 - St. Helena Island
Astronomic Stn '52	Astronomic Stn '52 - Marcus Island
Australian Geod '66	Australian Geod '66 - Australia, Tasmania Island
Australian Geod '84	Australian Geod '84 - Australia, Tasmania Island
Bellevue (IGN)	Bellevue (IGN) - Efate and Erromango Islands
Bermuda 1957	Bermuda 1957 - Bermuda Islands
Bogota Obsrvatry	Bogota Obsrvatry - Colombia
Campo Inchauspe	Campo Inchauspe - Argentina
Canto Astro 1966	Canto Astro 1966 - Phoenix Islands
Cape	Cape - South Africa
Cape Canaveral	Cape Canaveral - Florida, Bahama Islands
Carthage	Carthage - Tunisia
Chatham 1971	Chatham 1971 - Chatham Island (New Zealand)
Chua Astro	Chua Astro - Paraguay
Corrego Alegre	Corrego Alegre - Brazil
Djakarta (Batavia)	Djakarta (Batavia) - Sumatra Island (Indonesia)
Dos 1968	Dos 1968 - Gizo Island (New Georgia Islands)
Easter Island 1967	Easter Island 1967 - Easter Island
European 1950	European 1950 - Austria, Belgium, Denmark, Finland, France, Germany, Gibraltar, Greece, Italy, Luxembourg, Netherlands, Norway, Portugal, Spain, Sweden, Switzerland
European 1979	European 1979 - Austria, Finland, Netherlands, Norway, Spain, Sweden, Switzerland
Finland Hayford	Finland Hayford - Finland
Gandajika Base	Gandajika Base - Republic of Maldives

Geodetic Datum '49	Geodetic Datum '49 - New Zealand
Guam 1963	Guam 1963 - Guam Island
Gux 1 Astro	Gux 1 Astro - Guadalcanal Island
Hjorsey 1955	Hjorsey 1955 - Iceland
Hong Kong 1963	Hong Kong 1963 - Hong Kong
Indian Bangladesh	Indian - Bangladesh, India, Nepal
Indian Thailand	Indian - Thailand, Vietnam
Ireland 1965	Ireland 1965 - Ireland
ISTS 073 ASTRO '69	ISTS 073 ASTRO '69 - Diego Garcia
Johnston Island	Johnston Island - Johnston Island
Kandawala	Kandawala - Sri Lanka
Kergulen Island	Kergulen Island - Kerguelen Island
Kertau 1948	Kertau 1948 - West Malaysia, Singapore
L.C. 5 Astro	L.C. 5 Astro - Cayman Brac Island
Liberia 1964	Liberia 1964 - Liberia
Luzon Mindanao	Luzon - Mindanao Island
Luzon Philippines	Luzon - Philippines (excluding Mindanao Island)
Mahe 1971	Mahe 1971 - Mahe Island
Marco Astro	Marco Astro - Salvage Islands
Massawa	Massawa - Eritrea (Ethiopia)
Merchich	Merchich - Morocco
Midway Astro 1961	Midway Astro 1961 - Midway Island
Minna	Minna - Nigeria
NAD27 Alaska	NORTH AMERICAN 1927 - Alaska
NAD27 Bahamas	NORTH AMERICAN 1927 - Bahamas (excluding San Salvador Island)
NAD27 Canada	NORTH AMERICAN 1927 - Canada (including Newfoundland Island)
NAD27 Canal Zone	NORTH AMERICAN 1927 - Canal Zone
NAD27 Caribbean	NORTH AMERICAN 1927 - Caribbean (Barbados, Caicos Islands, Cuba, Dominican Republic, Grand Cayman, Jamaica, Leeward Islands, Turks Islands)
NAD27 Central	NORTH AMERICAN 1927 - Central America (Belize, Costa Rica, El Salvador, Guatemala, Honduras, Nicaragua)
NAD27 CONUS	NORTH AMERICAN 1927 - Mean Value (CONUS)
NAD27 Cuba	NORTH AMERICAN 1927 - Cuba
NAD27 Greenland	NORTH AMERICAN 1927 - Greenland (Hayes Peninsula)
NAD27 Mexico	NORTH AMERICAN 1927 - Mexico
NAD27 San Salvadr	NORTH AMERICAN 1927 - San Salvador Island
NAD83	NORTH AMERICAN 1983 - Alaska, Canada, Central America, CONUS, Mexico
Nahrwn Masirah Iland	Nahrwn - Masirah Island (Oman)

Nahrwn Saudi Arabia	Nahrwn - Saudi Arabia
Nahrwn United Arab	Nahrwn - United Arab Emirates
Naparima BWI	Naparima BWI - Trinidad and Tobago
Observatorio 1966	Observatorio 1966 - Corvo and Flores Islands (Azores)
Old Egyptian	Old Egyptian - Egypt
Old Hawaiian	Old Hawaiian - Mean Value
Oman	Oman - Oman
Ord Srvy Grt Britn	Ord Srvy Grt Britn - England, Isle of Man, Scotland, Shetland Islands, Wales
Pico De Las Nieves	Pico De Las Nieves - Canary Islands
Pitcairn Astro 1967	Pitcairn Astro 1967 - Pitcairn Island
Prov So Amricn '56	Prov So Amricn '56 - Bolivia, Chile, Colombia, Ecuador, Guyana, Peru, Venezuela
Prov So Chilean '63	Prov So Chilean '63 - South Chile
Puerto Rico	Puerto Rico - Puerto Rico, Virgin Islands
Qatar National	Qatar National - Qatar
Qornoq	Qornoq - South Greenland
Reunion	Reunion - Mascarene Island
Rome 1940	Rome 1940 - Sardinia Island
RT 90	SWEDEN
Santo (Dos)	Santo (Dos) - Espirito Santo Island
Sao Braz	Sao Braz - Sao Miguel, Santa Maria Islands (Azores)
Sapper Hill 1943	Sapper Hill 1943 - East Falkland Island
Schwarzreck	Schwarzreck - Namibia
South American '69	South American '69 - Argentina, Bolivia, Brazil, Chile, Colombia, Ecuador, Guyana, Paraguay, Peru, Venezuela, Trinidad and Tobago
South Asia	South Asia - Singapore
Southeast Base	Southeast Base - Porto Santo and Madeira Islands
Southwest Base	Southwest Base - Faial, Graciosa, Pico, Sao Jorge, and Terceira Islands (Azores)
Timbalai 1948	Timbalai 1948 - Brunei and East Malaysia (Sarawak and Sabah)
Tokyo	Tokyo - Japan, Korea, Okinawa
Tristan Astro 1968	Tristan Astro 1968 - Tristan da Cunha
Viti Levu 1916	Viti Levu 1916 - Viti Levu Island (Fiji Islands)
Wake-Eniwetok '60	Wake-Eniwetok '60 - Marshall Islands
WGS 72	WORLD GEODETIC SYSTEM 1972
WGS 84	WORLD GEODETIC SYSTEM 1984
Zanderij	Zanderij - Surinam

APPENDIX E

UTC TIME TO LOCAL TIME OFFSET

Reference the chart below to find the UTC-to-local time offset for your longitude zone. (If you are in a daylight savings time zone, add one hour to the offset.) For example, if you are at longitude W081°00.00' and UTC time is 16:00, local time is 11:00 standard time.

<u>Longitude Zone</u>		<u>Offset</u>
W180.0°	to W172.5°	- 12
W172.5°	to W157.5°	- 11
W157.5°	to W142.5°	- 10
W142.5°	to W127.5°	- 9
W127.5°	to W112.5°	- 8
W112.5°	to W097.5°	- 7
W097.5°	to W082.5°	- 6
W082.5°	to W067.5°	- 5
W067.5°	to W052.5	- 4
W052.5°	to W037.5°	- 3
W037.5°	to W022.5°	- 2
W022.5°	to W007.5°	- 1
W007.5°	to E007.5°	0
E007.5°	to E022.5°	+ 1
E022.5°	to E037.5°	+ 2
E037.5°	to E052.5°	+ 3
E052.5°	to E067.5°	+ 4
E067.5°	to E082.5°	+ 5
E082.5°	to E097.5°	+ 6
E097.5°	to E112.5°	+ 7
E112.5°	to E127.5°	+ 8
E127.5°	to E142.5°	+ 9
E142.5°	to E157.5°	+10
E157.5°	to E172.5°	+11
E172.5°	to E180.0°	+12

NOTE: The time zone boundaries given above may be different depending on your area. Consult your charts for more accurate information concerning time zones.

APPENDIX F

INDEX

A		C	
Active from waypoint	4-1	CDI Page	3-9
Active route	4-1	CDI Scale	6-5
Active Route Page	4-5	Clock, alarm	6-5
Active to waypoint	4-1	Confirmation field	2-2
Alarm Clock	6-5	Contrast, changing	6-6
Alarm/CDI Page	6-4	Coordinate entry	3-4
Alarms		Count down timer	6-5
alarm clock	6-5	Count up timer	6-5
anchor drag	6-4	Course made good (CMG)	B-2
arrival	6-4	Course to steer (CTS)	B-2
proximity	5-1	Crosstrack (XTK)	B-2
Along Track Distance (ATD)	B-3	Cursor	2-2
Alphanumeric field	2-2	Cyclic field	2-2
Altitude			
GPS	3-1	D	
manual entry	3-4	Data entry	2-4
units	6-3	Date/Time Page	6-5
Anchor drag alarm	6-4	Desired Track (DTK)	B-2
Arrival alarm	6-4	Differential GPS (DGPS)	6-7
Audio/Display Setup Page	6-6	Dilution of Precision (DOP)	B-3
AutoLocate™	3-4	Display	2-1
Automatic magnetic variation	6-3	Distance Made Good (DMG)	B-2
AutoStore™	3-6	Distance, track storing	6-2
Auxiliary Page	6-1		
B		E	
Backlighting		Estimated Position Error	
adjusting	2-3	(EPE)	B-3
timeout	6-6	Estimated Time Enroute	
Bar Graph, Satellite Status	3-2	(ETE)	B-2
Battery Saver mode	2-5	Estimated Time of Arrival	
Beacon Log Page	6-8	(ETA)	B-2
Beacon Receiver Page	6-8		
Bearing (BRG)	B-2		

F		Manual altitude entry	3-4
Field		Map datum	D-1
alphanumeric	2-2	Map Datum Page	6-7
bar	2-2	Message annunciator	2-4
confirmation	2-2	Message Page	6-11
cyclic	2-2	Messages, description	A-1
numeric	2-2	Metric Units	6-3
Filters		N	
position	6-1	Nautical units	6-3
velocity	6-1	Navigation	
Fuel Planning	6-10	2D	3-1
G		3D	3-1
GOTO waypoint	3-7	Navigation pages	3-8
Ground Speed (GS)	B-2	Navigation Summary Page	3-9
H		Navigation units	6-3
Heading Selection (HDG)	6-3	Nearest Waypoint Page	5-1
I		NMEA output	6-6
Installation	C-5	Normal mode	2-5
Interface format	6-6	Numeric field	2-2
Interface Page	6-6	O	
Interval, track storing	6-2	Offset, local time	6-5
K		Operating mode	2-5
Keypad		Operating Mode Page	6-1
using	2-2	Orientation	
tone	6-6	Plot	6-2
L		CDI	6-4
Local date/time	6-5	Output	
M		NMEA	6-6
Magnetic variation		WPT/RTE Transfer	6-6
automatic	6-3	P	
true north	6-3	Page	2-1
user-defined	6-3	Plot Page	3-10
Maintenance	C-8	Plot Page Scale	3-10
Man overboard (MOB)	3-11	Plot Page Setup	6-2
		Position entry	3-4
		Power off operation	2-2
		Power on operation	3-1
		Present Position Page	3-3
		Product Support	C-8

Proximity alarm	5-1	count up	6-5
Proximity Waypoint Page	5-1	Track (TRK)	B-2
R		Track storing	6-2
Range (RNG)	B-2	Trip planning	6-10
Relative Bearing Pointer	3-9	True heading	6-3
Resolution, track storing	6-3	Turn (TRN)	B-2
Route Definition Page	4-2	U	
Route List Page	4-5	Units/Heading Page	6-3
Routes		Units, selecting	6-3
activating	4-3	User-defined magnetic	
building with AutoStore™	4-6	variation	6-4
clearing	4-6	UTC time	6-5
copying	4-3	UTM coordinates	6-3
creating	4-2	V	
deleting	4-6	Velocity Made Good (VMG)	B-2
editing active routes	4-5	W	
editing storage routes	4-4	Waypoint Definition Page	3-5
navigating	4-1	Waypoint List	3-6
S		Waypoints	
Satellite Status		creating	3-5
bar graph	3-2	deleting	3-6
table	3-2	modifying	3-5
Satellite Status Page	3-2	nearest	5-1
Scale, Plot Page	3-10	proximity	5-1
Searching the sky	3-1	renaming	3-6
Self test	3-1	scanning	5-3
Setup operations	6-1	Wiring	C-3
Simulator mode	2-5	WPT/RTE Transfer	6-6
Skyview Display	3-3		
Statute units	6-3		
Steer to, CDI	6-4		
Sunrise/Sunset Planning	6-9		
T			
Time			
local	6-5		
UTC	6-5		
Timers			
count down	6-5		

GARMIN GPS

GARMIN

COMMUNICATION & NAVIGATION

GARMIN International, Inc.
9875 Widmer Road
Lenexa, Kansas 66215, USA
1-800-800-1020
(913) 599-1515

190-00038-00 Rev. D