

GPS 12XL

PERSONAL
NAVIGATOR

OWNER'S
MANUAL
& REFERENCE

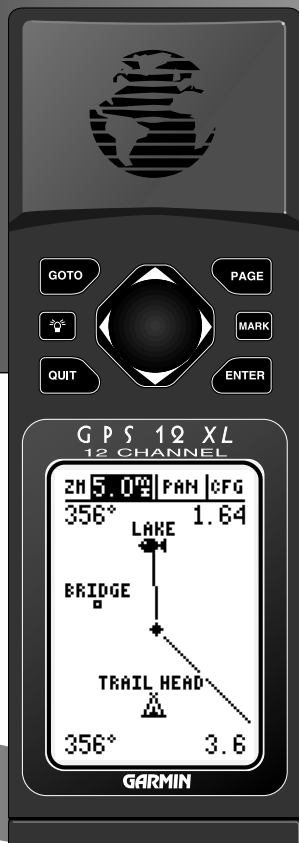

 **GARMIN®**

Software Version 3.0 or above
© 1997 GARMIN Corporation
1200 E. 151st Street, Olathe, Kansas 66062 USA
Tel: 913-397-8200 or 800-800-1020
Fax: 913-397-8282

GARMIN (Europe) Ltd.
Unit 5, The Quadrangle, Abbey Park, Romsey, Hampshire SO51 9AQ UK
Tel: 011-44-1794-519944
Fax: 011-44-1794-519222

Web Site Address: www.garmin.com

All rights reserved. No part of this manual may be reproduced or transmitted in any form or by any means including photocopying and recording, for any purpose without the express written permission of GARMIN.

Information in this document is subject to change without notice. GARMIN reserves the right to change or improve its products and to make changes in the content without obligation to notify any person or organization of such changes.

GARMIN, Personal Navigator, AutoLocate, TracBack, and PhaseTrac12 are all trademarks of GARMIN Corporation and may not be used without the expressed permission of GARMIN.

GPS 12XL OPERATOR'S MANUAL

Thank you for choosing the GARMIN GPS 12XL —the smallest, easiest-to-use GPS navigator for outdoor use! The GPS 12XL represents GARMIN's continuing commitment to provide quality navigation information in a versatile and user-friendly flexible design you'll enjoy for years. To get the most from your new GPS, take the time to read through the owner's manual in order to understand the operating features of the GPS 12XL. This manual is organized into four sections for your convenience:

Introduction gives a quick overview of the manual and contains the table of contents and the glossary of navigational terms.

Getting Started introduces you to the basic features of the unit and provides a quick-start orientation to the GPS 12XL.

Reference provides details about the advanced features and operations of the GPS 12XL by topic.

The **Appendix** section contains initialization instructions and items with multiple listings, such as map datums, time offsets, and the index.

Before getting started with your GPS, check to see that your GARMIN GPS 12XL package includes the following items. If you are missing any parts, please contact your dealer immediately.

Standard Package:

- GPS 12XL Unit
- Wrist Strap
- Carrying Case
- Owner's Manual
- Quick Reference Guide
- 4 AA Batteries

See your GARMIN dealer for accessories including our PC kit, swivel mounts, external antennas, and power/data cables.

We at GARMIN hope the GPS 12XL will help you meet all of your navigation needs and know it will become a valuable piece of your outdoor gear.



Caution

The GPS system is operated by the government of the United States, which is solely responsible for its accuracy and maintenance. The system is subject to changes which could affect the accuracy and performance of all GPS equipment. Although the GPS 12XL is a precision electronic NAVigation AID (NAVAID), any NAVAID can be misused or misinterpreted and, therefore, become unsafe.

Use the GPS 12XL at your own risk. To reduce the risk of unsafe operation, carefully review and understand all aspects of this Operator's Manual and thoroughly practice operation using the simulator mode prior to actual use. When in actual use, carefully compare indications from the GPS 12XL to all available navigation sources including the information from other NAVAIDs, visual sightings, maps, etc. For safety, always resolve any discrepancies before continuing navigation.

NOTE: This device meets requirements for Part 15 of the FCC limits for Class B digital devices for home or office use. It has been tested for compliance with all necessary FCC standards. This equipment generates, uses, and can radiate radio frequency energy and, if not installed and used in accordance with the instructions, may cause harmful interference to radio communications. However, there is no guarantee that interference will not occur in a particular installation. If this equipment does cause harmful interference to other equipment, which can be determined by turning the equipment off and on, the user is encouraged to try and correct the interference by relocating the equipment or connecting the equipment to a different circuit than the affected equipment. Consult an authorized dealer or other qualified service technician for additional help if these remedies do not correct the problem. Operation is subject to the following conditions: (1) This device cannot cause harmful interference, and (2) this device must accept any interference received, including interference that may cause undesired operation. The GPS 12XL does not contain any user-serviceable parts. Repairs should only be made by an authorized service center. Unauthorized repairs or modifications could void your warranty and your authority to operate this device under Part 15 regulations.

Table of Contents

SECTION ONE Introduction

Glossary	2-3
----------------	-----

SECTION TWO Getting Started

Battery & Remote Antenna Installation	4
Keypad Usage & Data Entry	5
Primary Page Overview	6-7
Power On & Marking a Position	8
Position Page, Map Basics, & Going To A Waypoint	9
Compass Page & Cancelling A GOTO	10
Clearing the Map Display, Screen Contrast, & Power Off	11

SECTION THREE Reference

Satellite Page	12-13
Battery Level Indicator, Backlighting, and Emergency Erase	14
Position Page & User Selectable Fields	15-16
Marking a Position & Position Averaging Function	17
Waypoint Pages & Managing Waypoints	18-23
TracBack Navigation	24-25
Creating and Using Routes	26-30
Using the Compass & Highway Pages	31-34
Map Page, Zooming, & Panning	35-38
Map Page & Track Log Setup	38-40
Menu Page & Distance/Sun Calculation	40
System Setup	41-42
Navigation Setup	43-44
Interface Setup & DGPS Interface	45-46
Navigation Simulator	47

SECTION FOUR Appendices

Appendix A—Initialization	48-49
Appendix B—Specifications & Wiring	50-51
Appendix C—Messages and Time Offsets	52-53
Appendix D—Map Datums	54-55
Appendix E—Index	56-58

Glossary

The GPS 12XL is a powerful navigation tool that can guide you anywhere in the world. To better understand its operation and capabilities, it may be helpful to review the basic terms and concepts briefly explained below.

Other navigation and GPS definitions used in the manual are defined in the appropriate reference sections of the manual.

Almanac Data

Satellite constellation information (including location and health of satellites) that is transmitted to your receiver from every GPS satellite. Almanac data must be acquired before GPS navigation can begin.

Bearing

The compass direction from your position to a destination.

Course Made Good (CMG)

The bearing from the “active from” position (your starting point) to your present position.

Crosstrack Error (XTK)

The distance you are off a desired course in either direction.

Desired Track (DTK)

The compass course between the “from” and “to” waypoints.

Differential GPS (DGPS)

An extension of the GPS system that uses land-based radio beacons to transmit position corrections to GPS receivers.

Estimated Time of Arrival (ETA)

The time of day of your arrival at a destination.

Estimated Time Enroute (ETE)

The time left to your destination at your present speed.

Grid

Coordinate system that projects the earth on a flat surface, using square zones for position measurements. UTM/UPS and Maidenhead formats are grid systems.

Ground Speed

The velocity you are traveling relative to a ground position.

Latitude

The north/south measurement of position perpendicular to the earth's polar axis.

Longitude

An east/west measurement of position in relation to the Prime Meridian, an imaginary circle that passes through the north and south poles.

Navigation

The process of traveling from one place to another and knowing where you are in relation to your desired course.

Position

An exact, unique location based on a geographic coordinate system.

Track (TRK)

The direction of movement relative to a ground position.

Universal Transverse Mercator (UTM)

A grid coordinate system that projects global sections onto a flat surface to measure position in specific zones.

Velocity Made Good (VMG)

The speed you are traveling in the direction of the destination.

Waypoint

A specific location saved in the receiver's memory.

Battery Installation

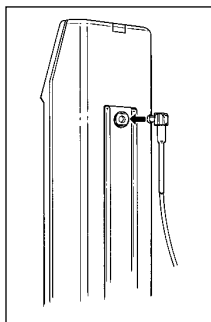

Remote Antenna Installation

An optional remote antenna may be used with the GPS 12XL. The remote antenna will improve the receiving capabilities of the unit by magnifying weaker signals which the built-in antenna may not be able to use.

The remote antenna is attached by plugging it into the connector on the back of the unit (see above).

Contact your GARMIN dealer for remote antennas and accessories.

Battery Installation

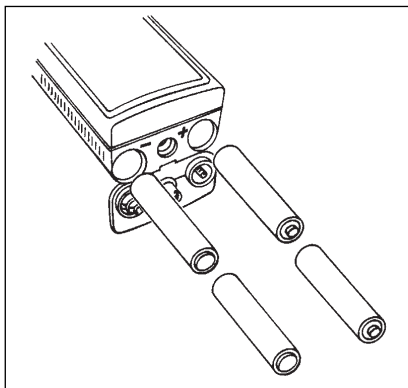









The GPS 12XL operates on 4 AA batteries (included), which are installed at the base of the unit. These batteries provide up to 12 hours of use.

To install the batteries:

1. Remove the battery cover by turning the thumb loop at the bottom of the unit 1/4 turn counter-clockwise.
2. Insert the batteries into position. The battery pole you can still see should match the symbol (+ or -) marked on the case.
3. Replace and secure the battery cover by turning the thumb loop 1/4 turn clockwise.

Battery life varies due to a variety of factors, including temperature and backlighting. You may find that lithium batteries provide longer life in colder conditions.

Keypad Usage &
Data Entry

	Turns the unit on and off and activates screen backlighting.
	Scrolls through the main data pages in sequence and returns display from a submenu page to a primary page.
	Captures a position and displays the mark position page.
	Displays GOTO page with the waypoint highlighted for GOTO operation. Pressing GOTO twice activates MOB.
	Confirms data entry and activates highlighted fields to allow data entry.
	Returns display to a previous page, or restores a data field's previous value.
	Selects alphanumerical characters and menu choices and moves the field highlight from field to field.
	Moves the selected character field and moves the field highlight from field to field.

DATA ENTRY

The arrow keypad is used for all data entry. Use the ▲ and ▼ keys to select letters, numbers, and menu options; use the ◀ and ▶ keys to move the cursor forward or backward along the line. Press  to confirm your entry.

Primary Pages

Primary Pages

Before we start the tour, let's briefly look at the five primary information pages used for the GPS 12XL. Switch between pages by pressing either the **QUIT** or **PAGE** keys.

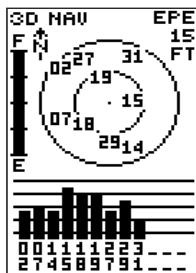
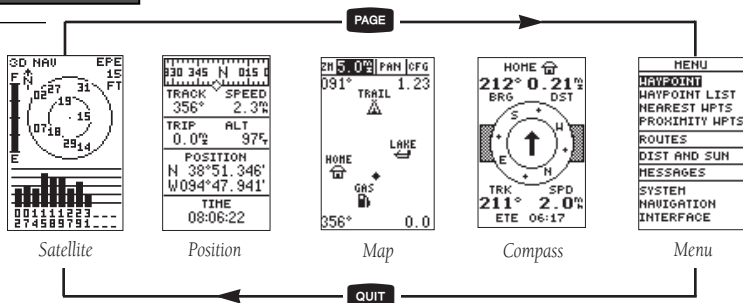

Satellite Page

The Satellite Page will allow you to monitor satellite signal reception and strength.

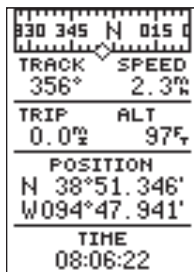

Position Page

Satellite Page

The **Satellite Page** shows satellite positions and signal strength. Satellite positions are displayed using two circles and a center point. The outer circle shows satellites on level with the horizon; the inner circle is 45° above the horizon; and the center point represents satellites directly overhead. Knowing satellite positions will show you the direction of any blocked signals.

The bottom of the page contains a row of signal strength bars corresponding to each satellite being used.

Position Page

The **Position Page** shows you where you are, what direction you're heading and how fast you're going.

The top of the page contains a compass tape which is a graphic representation of your heading. Your track and speed are indicated immediately below.



The graphic compass tape reflects your heading only while you are moving.

The rest of the page shows your current position in three dimensions: latitude, longitude, and altitude. A trip odometer and 12/24-hour clock are also provided.

Map Page

The **Map Page** acts as a window. It allows you to view your position, the “path” you have traveled over, and nearby waypoints.

A diamond icon in the center of the screen represents your current position. As you move, you will see a thin line - called a *track log* - appear along the path you have just covered. Names of stored waypoints can also be shown on the map.

The bottom corners of the map will always display your current track and speed. When going to a waypoint, highlighting an on-screen waypoint, or using the panning target crosshair, the corresponding distance and bearing are shown at the top corners of the map. The top of the screen contains the zoom, pan, and configuration fields.

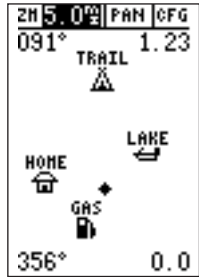

Map Page

The *Map Page* shows your progress on a moving map plotter and gives a bird's-eye-view of surrounding waypoints.

Navigation Page

A navigation page gives you steering guidance when going to a waypoint. The GPS 12XL has two navigation page choices: the **Compass Page** and the **Highway Page**. The **Compass Page** is the default and will be briefly explained here. The **Highway Page** is covered on pages 35 and 38.

The **Compass Page** shows the destination waypoint at the top of the page with the bearing (BRG) and distance (DST) to the waypoint shown below. The center of the page contains a compass ring and arrow to show you the direction of the waypoint from the direction you are moving. The bottom of the page gives your track (TRK), speed (SPD), and a selectable field for estimated time to arrival (ETA), estimated time enroute (ETE), course to steer (CTS), crosstrack error (XTK), velocity made good (VMG), or turn bearing (TRN).

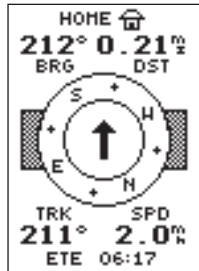

Compass Page

The *Compass Page* is the default navigation page and will show you the way to the waypoint from the direction you are moving.

Menu Page

The last primary page is the **Menu Page**. The **Menu Page** gives you access to the GPS 12XL's waypoint management, route, track log, and setup features through a list of submenus.

**Power On &
Marking a
Position**

The welcome page will be shown while the unit conducts a self test



Press the UP arrow to move forward through the alphabet or numbers and the DOWN arrow to move backward.

Getting Started Tour

Now that you've seen the primary pages, let's get started by taking a simple tour to show you the basics about using your GPS 12XL. The tour assumes that your unit has been turned on and that none of the factory settings (units of measure, selectable fields, etc.) have been changed. If these settings have been changed, the pictures and descriptions you see in this manual may not match what you see on your screen.

Turning the GPS 12XL On

1. Press until the receiver turns on.

The welcome page will appear while the unit conducts a self test. Once testing is complete, the Satellite Page will appear. When sufficient satellite signals have been acquired, the Satellite Page will be replaced by the Position Page.

Marking a Position

GPS is really about marking and going to places called waypoints. Before we can use our GPS 12XL to guide us somewhere, we have to mark a position as a waypoint. (Your GPS 12XL can hold up to 500 waypoints.)

To mark your present position:

1. Press the key. The mark position page will appear, with a default three-digit name for the new waypoint in the upper-left portion of the page.

To rename the waypoint:

1. Highlight the name field, and press .
2. Enter the waypoint name 'HOME', and press . (See pg. 9 for data entry.) The waypoint symbol field will become highlighted.

Each waypoint may also be assigned a custom waypoint symbol for easy waypoint recognition on the map.

To change the waypoint symbol:

1. Highlight the waypoint symbol field, and press .
2. Select the house symbol, and press .
3. Move the cursor to the 'DONE?' prompt, and press .

**Position/Map
Pages & Going
To a Waypoint****Using the Position Page**

Walk for 3-4 minutes and watch the Position Page. The direction you are moving (track), your speed, trip distance, and altitude are shown on the upper half of the screen. The latitude and longitude of your position are displayed in the middle of the page, with the time of day shown below.

Let's continue by moving to the next page:

1. Press **PAGE**.

Map Page

The next page is the Map Page. To ensure we can see our entire trip on the map, let's change the map scale from .2nm (default) to 5nm.

1. Use the arrow keys to highlight the 'ZM' field at the top left of the Map Page and press **ENTER**.
2. Press the **▲** arrow until '1nm' is shown and press **ENTER**.

The Map Page shows your present position as a diamond icon in the center of the map. The house symbol labeled 'HOME' is the waypoint you created and the line connecting the two is your track log.

1. Now turn approximately 90° to your right and continue walking at for another 2-3 minutes. Notice how the display changes, always keeping the direction you are moving at the top of the map (see right).

Going to a Waypoint

Once you've stored a waypoint in memory, you may return to it by performing a GOTO. A GOTO is a straight-line course from your present position to the destination you've selected. Let's navigate back to our starting position, the HOME waypoint.

To select a GOTO destination:

1. Press **GOTO**.
2. Highlight the 'HOME' waypoint, and press **ENTER**.

You'll notice that you'll automatically return to the Map Page, and a straight line will connect your current position to the position of the GOTO waypoint.

Let's continue by moving to the next page:

1. Press **PAGE**.

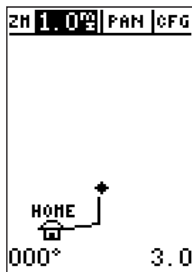

The Map Page displays your present position as a diamond icon and provides a real-time graphic "breadcrumb" display of your track right on the screen.



The GOTO waypoint page allows you to select a destination from a list of all available waypoints in the GPS 12XL's memory.

GETTING STARTED

Compass Page and Cancelling a GOTO

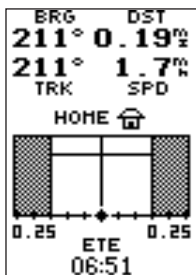

The GPS 12XL will also provide steering guidance with a Highway Page.

To change the display from the Compass Page, press ENTER twice.



Once a GOTO is activated, the GPS 12XL provides steering guidance until the GOTO is canceled. To cancel a GOTO, highlight the cancel prompt at the bottom of the page and press ENTER.

Compass Page

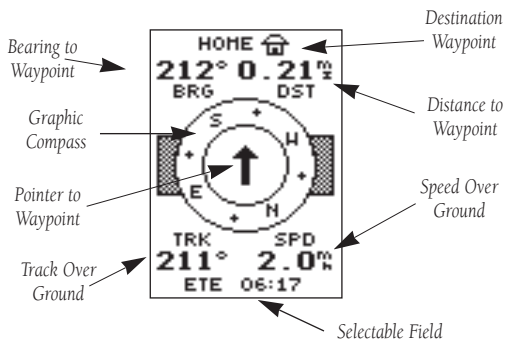

Whenever you select a destination waypoint, the GPS 12XL provides graphic steering guidance with the Compass Page (the default navigation page). The “compass ring” in the middle of the page shows your course over ground while you’re moving, with a pointer arrow to the destination displayed in the center. The arrow shows the direction of your destination from the direction you are moving. For instance, if the arrow points up, you are going directly to the waypoint. If the arrow points any other direction (left, right, down, etc.), turn toward the arrow until it points up. Then continue in that direction.

The bearing and distance to a waypoint are displayed at the top of the screen, and your current track and speed are shown below. The default ‘ETE’ field, at the bottom of the screen, is a user-selectable field that can provide a variety of navigation information. We’ll cover more about that field in the reference section (see page 36).

As you get close to ‘HOME’, you’ll be alerted to press PAGE. The GPS 12XL will give you the message “Approaching HOME”. Once you’ve arrived, you’ll notice the distance field will read 0.00.

Cancelling a GOTO

If you decide to stop navigating to the active waypoint, all you have to do is cancel the GOTO.

To cancel an active GOTO:

1. Press the **GOTO** key.
2. Use the arrow keypad to move the field highlight to the ‘CANCEL GOTO’ prompt at the bottom of the page and press **ENTER**.

Clearing the Map, Adjusting Contrast, & Power Off

Clearing a Cluttered Map Display

After you've used the GPS 12XL for a few trips, you may find that your map display has become a bit messy from keeping track of your every move. For practice, let's clean up the screen by clearing the track log (the plot points left on the Map Page) we've just created during the Getting Started tour.

1. Press **PAGE** or **QUIT** until the Map Page appears.
2. Highlight the 'CFG' field and press **ENTER**.
3. Highlight 'Track Setup' and press **ENTER**.
4. Highlight the 'CLEAR LOG?' option and press **ENTER**.
The clear log confirmation page will appear.
5. Use the **◀** key to highlight the 'Yes' prompt.
6. Press **ENTER** to finish.

Adjusting Screen Contrast

You can access the GPS 12XL's contrast feature from the Satellite Page.

To adjust the screen contrast:

1. Press **PAGE** or **QUIT** until the Satellite Page appears.
2. Press **◀** or **▶** to adjust the level of contrast, and press **ENTER**.

Screen Backlighting

Screen backlighting is available for nighttime use. Activate backlighting by pressing the **☾** key briefly. Backlighting will remain on for the time specified on the system setup page (See page 42).

Turning the Receiver Off

You've now gone through the basic operation of your new GPS receiver and probably know a little more than you think about how it works. We encourage you to experiment with the GPS 12XL until it becomes an extension of your own navigation skills. If you encounter any problems using the unit or want to take advantage of the GPS 12XL's more advanced features, turn to the reference section.

To turn the GPS 12XL off:

1. Press and hold the **☾** key for 3 seconds.



Highlight the 'CLEAR LOG?' prompt and press **ENTER** to clear the track log.

Note: Once all 1024 points are used during normal operation, the oldest point will be continuously deleted to make room for the latest track log point to be stored.

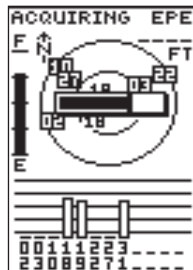

Pressing the **LEFT** or **RIGHT** arrows from the Satellite Page will automatically activate the screen contrast bar.

Satellite Page

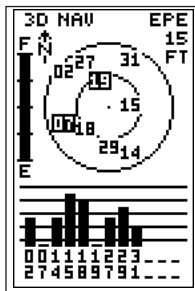

The GPS 12XL Satellite Page will help you determine which satellites are in view, and whether or not any satellites are being “shaded” or blocked from receiving satellite signals (See satellites 07 and 09 above).

By periodically monitoring the signal strength bars at the bottom of the page and the north up sky view, you will be able to see how moving to another area with a clearer view of the sky will improve satellite reception and speed up signal acquisition.

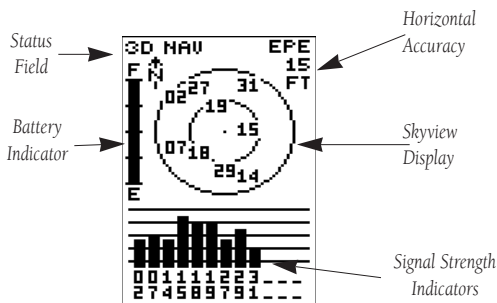
Satellite Page

The GPS 12XL's Satellite Page displays the status of various receiver functions. The status information will help you understand what the GPS 12XL is doing at any given time, and will tell you whether or not the receiver has calculated a position fix.

Sky View and Signal Strength Bars

The sky view and signal strength bars give you an indication of what satellites are visible to the receiver, whether or not they are being used to calculate a position fix, and the signal quality. The satellite sky view shows a bird's-eye-view of the position of each available satellite relative to the unit's last known position. The outer circle represents the horizon (north up); the inner circle is 45° above the horizon; and the center point is directly overhead. You can use the sky view to help determine if any satellites are being blocked, and whether you have a current position fix (indicated by a '2D NAV' or '3D NAV' in the status field). You can also set the sky view to a track up configuration by changing the 'orientation' option on the Map Page. (See pg. 38 for setup instructions.)

When the receiver is looking for a particular satellite, the corresponding signal strength bar will be blank and the sky view indicator will be highlighted. Once the receiver has found the satellite, a hollow signal strength bar will appear, indicating that the satellite has been found and the receiver is collecting data from it. The satellite number in the sky view will no longer appear highlighted. As soon as the GPS 12XL has collected the necessary data to calculate a fix, the status field will indicate a 2D or 3D status.

Receiver Status & EZinit

Receiver Status

Receiver status is indicated at the top left of the page, with the current horizontal accuracy (estimated position error, in feet or meters) at the top right. The status will be shown as one of the following conditions:

Searching— the GPS 12XL is looking for any available satellites in view.

AutoLocate— the GPS 12XL is initializing and collecting new almanac data. This process can take 5 minutes, depending on the satellites currently in view.

Acquiring— the receiver is collecting data from available satellites, but has not collected enough data to calculate a 2D fix.

2D Nav (2D Navigation)— at least three satellites with good geometry have been locked onto and a 2-dimensional position fix (latitude and longitude) is being calculated. '2D Diff' will appear when you are receiving DGPS corrections in 2D mode.

3D Nav (3D Navigation)— at least four satellites with good geometry have been locked onto, and your position is now being calculated in latitude, longitude and altitude. '3D Diff' will appear when you are receiving DGPS corrections in 3D mode.

Poor Cvg (Poor GPS Coverage)— the receiver isn't tracking enough satellites for a 2D or 3D fix due to bad satellite geometry.

Not Usable— the receiver is unusable, possibly due to incorrect initialization or abnormal satellite conditions. Turn the unit off and back on to reset, and reinitialize the receiver if necessary.

Simulator— the receiver is in simulator mode.

EZinit Option Prompt

The Satellite Page also provides access to the EZinit prompt whenever a position fix has not been calculated. (The unit must be in searching, AutoLocate, acquiring, simulator, or poor coverage mode.) This allows you to reinitialize the unit (see Appendix A), and is useful if you have traveled over 500 miles with the receiver off and must initialize your new position. (The EZinit prompt will automatically appear if the receiver needs to be initialized. The prompt may also appear during normal use if the antenna is shaded or the unit is indoors.

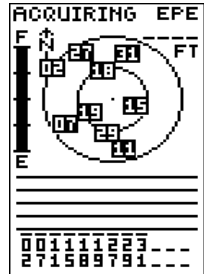

The signal strength bars at the bottom of the page will not appear until the GPS 12XL has found the satellites indicated at the bottom of the screen.

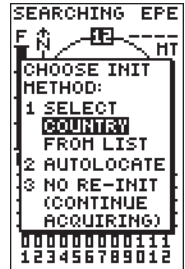

If you travel more than 500 miles with the receiver off, reinitialize the unit to your new position by using the EZinit feature. To access EZinit, press ENTER from the Satellite Page before any satellites are acquired.

Battery Level, Backlighting & Emergency Erase

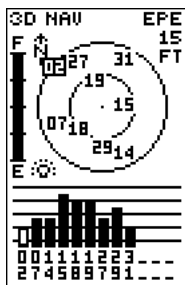

When backlighting is on, a bulb icon will appear on the Satellite Page.

Use the icon to determine if backlighting is turned on during daylight hours.



Upon activating the Emergency Erase Function, you will be asked to confirm your decision.

Battery Level Indicator

The Satellite Page also features a battery level indicator, located to the left of the sky view, which displays the strength of the unit's batteries. The battery indicator will not appear if the receiver is using external power.



The battery level indicator is calibrated for alkaline batteries. Voltage differences will display Ni-Cad and lithium batteries differently. No other receiver functions are affected.

The GPS 12XL features an internal lithium battery that will maintain the unit's memory when the receiver is not running off batteries or external power.





Backlighting Bulb Icon

The GPS 12XL features full-screen backlighting. Activate the backlight by pressing the  key briefly. Note: A bulb icon will appear on the Satellite Page when backlighting is turned on.

Emergency Erase Function

You may erase the GPS 12XL's memory in four quick steps. This will cause all stored data to be deleted, including: routes, waypoints, and the track log.

To erase all stored data:

1. Ensure that the GPS 12XL is turned off.
2. While holding down the  key, hold down the  key to turn the unit on. A warning message will appear with "Yes?" highlighted, and ask you to confirm your selection.
3. If you **do not** wish to erase all stored data, press  and  to cancel the emergency erase.
4. If you **do** wish to complete the emergency erase, press  to confirm.

Position Page

The second page in the GPS 12XL's primary page sequence is the Position Page. This page shows you where you are, what direction you're heading, and how fast you're going, and it's most useful when you are traveling without an active destination waypoint. The graphic heading display at the top of the page indicates the direction you're heading (while you're moving).

Directly below this display are the track, speed, and trip odometer fields (default). Track is the compass direction representing your course over the ground, and speed is how fast you're moving. The lower left-hand corner of the page shows your current latitude and longitude in degrees and minutes. The GPS 12XL uses this basic information to mark exact positions as waypoints, which help guide you from one place to another. The lower right-hand corner of the page contains the altitude field (default). Below that field is a 12- or 24-hour clock.

Both the trip odometer and the altitude fields are user selectable, and both offer a trip odometer, trip timer, and elapsed time. This way, you can always be sure of viewing this information regardless of the option you've selected to view in the other user-selectable field.

The following user-selectable options are available on the Position Page:

Trip Odometer (TRIP)— total distance traveled since last reset.

Trip Timer (TTIME)— total (cumulative) time in which a ground speed has been maintained since last reset.

Elapsed Time (ELPSD)— hours and minutes since last reset.

Average Speed (AVSPD)— average speed traveled.

Maximum Speed (MXSPD)— maximum speed traveled since last reset.

Altitude (ALT)— vertical distance above sea level.

REFERENCE

Position Page

S 195 210 SW	
TRACK	SPEED
202°	4.0%
TRIP	ALT
1.2%	97%
POSITION	
N 38°50.465'	
W094°47.596'	
TIME	
08:02:11am	

The speed and track displayed on the Position Page may fluctuate at slow speeds (or when you're standing still) because of position errors caused by Selective Availability.

S 195 210 SW	
TRACK	SPEED
197°	4.0%
AVSPD	ALT
58.3%	97%
POSITION	
N 38°50.444'	
W094°47.608'	
TIME	
08:02:35am	

The user selectable fields on the Position Page give you a variety of information to choose from.

Maximum Speed & Altitude Fields

195 210 SW 240	
TRACK	SPEED
221°	4.0%
TRIP	ALT
Reset?	96%
POSITION	
N 38°45.315'	
W094°47.609'	
TIME	
10:00:50am	

Resetting the trip odometer will erase the previous mileage and set the odometer to 0.

195 210 SW 240	
TRACK	SPEED
220°	4.0%
TRIP	ALT
7.6%	00096%
POSITION	
N 38°45.304'	
W094°47.622'	
TIME	
10:01:06am	

You may enter a known altitude to assist the GPS 12XL in establishing a 3-D fix.

To reset timer, speed measurement, or odometer:

1. Highlight the user-selectable field, and press **ENTER**.
2. Press **ENTER** to confirm or **QUIT** to exit.

The trip odometer, trip timer, and average speed fields are linked. Resetting one of these options in a user-selectable field will automatically reset the corresponding data in the other. This ensures that information shown in these fields reflects your current trip.

Maximum Speed Field

To obtain the most accurate reading of average speed, keep in mind that due to the sensitivity of the GPS 12XL's antenna, your maximum speed value may include the effects of rapid movement, such as swinging your arm while holding the unit.

To reset the maximum speed field:

1. Highlight the 'MXSPD' field, and press **ENTER**.
2. Press **ENTER** to confirm the 'RESET?' prompt.

Altitude Field

When the GPS 12XL is acquiring satellites or navigating in the 2D mode, the last known altitude is used to compute your position. You may also manually enter your altitude for greater accuracy. In cases where the GPS 12XL has 2D coverage, entering your approximate altitude will enable the receiver to determine a 3D fix.

To enter an altitude:

1. Highlight the 'ALT' field, and press **ENTER**.
2. Enter a value, and press **ENTER**.

Position Averaging

Marking a Position

The GPS 12XL allows you to mark and store up to 500 position as waypoints. A waypoint can be entered by taking an instant electronic fix, by manually entering coordinates (pg. 20), or by using the bearing and distance to a known position (pg. 20).

To mark your present position:

1. Press **MARK**. The mark position page will appear, showing the captured position and a default three-digit name.
2. To save a default name and symbol, press **ENTER** to confirm the 'SAVE?' prompt.

Position Averaging Function

The GPS 12XL positioning averaging function will help reduce the effects of selective availability upon position error when marking a waypoint.

1. After you have pressed the **MARK** key, highlight the 'AVERAGE?' field and press **ENTER**. The Figure of Merit (FOM) field will display the value reflecting estimated accuracy of the averaged position. Note: As the GPS 12XL calculates the FOM, it will rapidly change before it stabilizes on one number.
2. The unit will continue averaging until you have highlighted 'SAVE?' and pressed **ENTER**.

To enter a different waypoint name:

1. Highlight the waypoint name field, and press **ENTER**.
2. Make the appropriate changes, and press **ENTER**.
3. Highlight 'SAVE?', and press **ENTER**.

Note: To enter a different waypoint symbol or comment, see pg. 21.

To add this waypoint to a route:

1. Highlight the 'Add to route number' field, and press **ENTER**.
2. Enter a route number, press **ENTER** to confirm the route number, and **ENTER** again to save the waypoint.

HARK POSITION	
Waypoint:	001
N	38°51.334'
W	094°47.941'
Add to route number:	__
FOM	34.1%
AVERAGE?	
SAVE?	

After initiating the position averaging function, a Figure of Merit value will be displayed, and the 'SAVE?' field will automatically be highlighted.

HARK POSITION	
Waypoint:	001
N	38°51.334'
W	094°47.941'
Add to route number:	__
FOM	____%
AVERAGE?	
SAVE?	

The GPS 12XL will save new waypoints with a default three-digit name. To add the waypoint to a route, enter the desired route number, highlight 'SAVE?' and press ENTER.

Nearest Waypoints & Waypoint List

HENU
WAYPOINT
WAYPOINT LIST
NEAREST WPTS
PROXIMITY WPTS
ROUTES
DIST AND SUN
MESSAGES
SYSTEM
NAVIGATION
INTERFACE

To select a waypoint sub-menu, highlight the desired option and press ENTER.

NEAREST WPTS		
WAYPNT	BRG	DST
HOME	145'	0.00
GAS	135'	1.26
LAKE	070'	2.25
TRAIL	025'	2.54
003	356'	3.06
ESTADO	332'	4.33
002	133'	5.03
LODGE	248'	87.8
-----	---	----

Nearest Waypoints Page

The compass heading (BRG) and distance (DST) to the nine nearest waypoints are updated continuously.

Waypoint Pages

The GPS 12XL has three waypoint pages that let you quickly manage up to 500 waypoints. These pages—nearest waypoints, waypoint list, and waypoint definition—can be accessed through the Menu Page.

To select a waypoint page:

1. Access the Menu Page, and highlight a waypoint page option.
2. Press **ENTER**.

Nearest Waypoints Page

The nearest waypoints page shows the nine nearest waypoints that are within 100 miles of your present position, with the bearing and distance noted for each waypoint. This page will also let you retrieve a waypoint definition page or GOTO a selected waypoint right from the list.

To review the waypoint definition page of a selected waypoint:

1. Highlight the desired waypoint.
2. Press **ENTER**.

To return to the nearest waypoint page:

1. Highlight 'DONE?'
2. Press **ENTER**.

To go to a highlighted list waypoint:

1. Highlight the desired waypoint, and press **GOTO**.
2. Press **ENTER**.

Waypoint List Page

The waypoint list page provides a complete list of all waypoints currently stored in the GPS 12XL and their respective waypoint symbols. The total number of empty and used waypoints is also indicated. From the waypoint list page, you can retrieve a waypoint definition page, delete all user-defined waypoints, delete waypoints by symbol, or review and perform a GOTO to a selected waypoint.

To delete all user-defined waypoints:

1. Highlight 'DELETE WPTS?', and press **ENTER**.

Waypoint List & Proximity Waypoints

Waypoint List Page (continued)

An options page will appear, asking if you want to delete all user-defined waypoints or if you want to delete waypoints by symbol type.

1. Highlight either 'ALL' or 'SYMBOL', and press **ENTER**.

If you highlight 'SYMBOL,' you'll be asked to select a symbol.

1. Select the symbol to be deleted, and press **ENTER**.
2. Press **ENTER** to confirm the 'DONE' prompt, highlight the 'YES?' prompt, and press **ENTER**.

Note: This feature is handy for deleting temporary waypoints created by the TracBack function.

Proximity Waypoints

The GPS 12XL's proximity waypoint function warns you when you are getting too close to hazardous waypoints. This function allows you to create up to nine proximity waypoints and designate an alarm circle for each waypoint. If you enter this circle, a warning message will alert you.

To enter a proximity waypoint from the Menu Page:

1. Highlight 'PROXIMITY WPTS' and press **ENTER**.
2. Highlight the first empty waypoint field and press **ENTER**.
3. Use the **▲** or **▼** key to scroll through stored waypoints until the desired waypoint appears.
4. Press **ENTER**. The distance (DST) field will be automatically highlighted. Enter the desired distance.
5. Press the **ENTER** key.

To review or remove a proximity waypoint:

1. Use **▲** and **▼** to select a proximity waypoint and press **ENTER**.
2. Highlight 'REVIEW?' or 'REMOVE?' and press **ENTER**.

If 'REVIEW?' is chosen, the waypoint page will appear, and you may make any changes to the selected waypoint. If 'REMOVE?' is chosen, the proximity waypoint page will reappear with the waypoint removed. Press **QUIT** or **PAGE** to return to the Menu Page.



Deleting waypoints by symbol enables you to delete a specific group of waypoints without losing all other waypoints.



Quickly edit proximity waypoints by highlighting the waypoint name and pressing **ENTER**.

REFERENCE

Waypoint Definition & Reference Waypoints

WAYPOINT	
DOCK ←	
N 38°51.334'	
W094°47.941'	
17-APR-97 10:37	
REF: HOME_	
BRG	DST
000°	0.00
RENAME?	NEW?
DELETE?	DONE?

The GPS 12XL's advanced waypoint planning features allow you to create new waypoints and practice navigation without ever setting foot outside.

If you create a new waypoint by entering coordinates from a map, you may want to re-mark the waypoint's exact position once you get there.

To re-define an existing waypoint's position coordinates from the waypoint definition page, simply highlight the DST field and press ENTER. Use the LEFT arrow key to set the distance to 0.00, and press ENTER to confirm.

The old coordinates will be replaced by the coordinates of your present position (you must have a valid 2D or 3D position fix).

Waypoint Definition Page

Waypoint Name	WAYPOINT	
	CAMP ▲	Position Coordinates
	N 38°51.480'	
	W094°47.607'	
	17-APR-97 18:12	Waypoint Comment
Reference Waypoint	REF: -----	
	BRG DST	Distance from Reference Waypoint
Bearing from Reference Waypoint	057° 0.34	
	RENAME? NEW?	
	DELETE? DONE?	
	Function Prompts	

The waypoint definition page lets you create new waypoints manually or review and edit an existing waypoint's coordinates, symbols, and comments. It is also used to delete an individual waypoint from memory (see pg. 22). To create a new waypoint manually, you'll need to know its position coordinates or its approximate distance and bearing from an existing waypoint.

To create a waypoint by entering coordinates:

1. From the waypoint definition page, highlight 'NEW?', and press **ENTER**.
2. Enter a waypoint name, and press **ENTER**.
3. Press **ENTER** to select a waypoint symbol, make your selection, and press **ENTER**.
4. Highlight the 'DONE?' prompt, and press **ENTER** to return to the waypoint page.
5. Highlight the "position" field, enter your position, and press **ENTER**.
6. Press **ENTER** to confirm the 'DONE?' prompt.

Reference Waypoints

To create a new waypoint manually without knowing its position coordinates, you'll need to enter its bearing and distance from an existing waypoint or your present position.

To create a new waypoint by referencing a stored waypoint:

1. From the waypoint definition page, highlight 'NEW?', and press **ENTER**.
2. Enter a waypoint name, and press **ENTER**.

Waypoint Symbols & Comments

Reference Waypoints (cont.)

- Highlight the 'REF' field, and press **ENTER**.
- Enter a reference waypoint name (or leave the field blank to use your present position), and press **ENTER**.
- Enter the bearing and distance of your new waypoint from the reference waypoint.
- Press **ENTER** to confirm the 'DONE?' prompt.

Waypoint Symbols

The GPS 12XL allows you to select one of 16 symbols for each waypoint for easy recognition on the map display. From the symbol page, you may also select how the waypoint information is displayed on the map.

To select a waypoint symbol:

- Highlight the symbol field, and press **ENTER**.
- Use the arrow keypad to select the desired symbol, and press **ENTER**.
- The cursor will move to the display field, where you can select which waypoint information is displayed on the map.
- Press **ENTER**, and select one of the following display options: 'NAME WITH SYMBOL', 'SYMBOL ONLY', or 'COMMENT WITH SYMBOL'.
- Press **ENTER** to confirm your selection, and again to confirm the 'DONE?' prompt.

Waypoint Comments

Each waypoint stored in the GPS 12XL has a user-defined 16-character comment field. The default comment is the UTC (or Greenwich mean time) date and time of the waypoint's creation.

To change or add a comment:

- Highlight the comment field.
- Press **ENTER**.

Note: You can clear the comment field by pressing the left side of the rocker keypad.

- Enter the desired comment.
- Press **ENTER**.



Waypoint symbols enable you to instantly get more information about a waypoint than just its name.

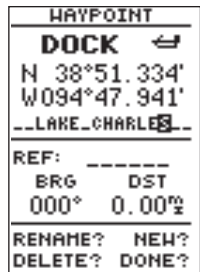

The waypoint comment field will automatically assign the date and time of creation to the waypoint comment field. You may enter a 16-character user comment at any time.

Rename, Delete & Scan Waypoints

RENAME WAYPT
From
003
To:
TRAIL
Are you sure Yes? or No?

You may wish to quickly save waypoints by pressing MARK and then ENTER, thus assigning a default name. You may then rename the waypoint at a later date. Any waypoint may be renamed at any time.

WAYPOINT	
E	STAI
N 38°50.514'	
W 094°47.012'	
17-APR-97 08:51	
REF: -----	
BRG	DST
135°	1.26 ^{mi}
RENAME?	NEW?
DELETE?	DONE?

Scanning waypoints from the waypoint definition page gives you instant access to a specific waypoint's information.

Renaming and Deleting Waypoints

The rename and delete function fields are located along the bottom side of the waypoint definition page.

To rename a stored waypoint:

1. Highlight 'RENAME?', and press **ENTER**.
2. Enter the new waypoint name, and press **ENTER**.
3. Press **ENTER** to confirm the 'Yes?' prompt.

To delete a stored waypoint:

1. Highlight 'DELETE?', and press **ENTER**.
2. Highlight the 'Yes?' prompt, and press **ENTER**.

Note: To delete a waypoint that's part of a route, first remove the waypoint from the route (see pg. 30), and then delete it. If you attempt to delete a waypoint that's part of a route, you'll be given a "Route Waypoint Can't be Deleted" message.

Scanning Waypoints

As you manually enter a waypoint's name, the GPS 12XL's waypoint scanning feature will automatically display the first numerical or alphabetical match of the character you have entered to that point. This helps eliminate the need to always enter a waypoint's complete name.

To scan waypoints from a waypoint field:

1. Highlight the waypoint name field, and press **ENTER**.
2. Press the left side of the keypad to clear the name field.
3. Scroll through the waypoints.

Note: The GPS 12XL's waypoint scanning feature will offer the first waypoint that matches the character or characters you have entered up to that point. If you have more than one waypoint that begins with the same letter or number, move to the next character position as needed.

4. When you find the desired waypoint, press **ENTER**.

Select a GOTO & MOB Function

Selecting a GOTO Destination

The GPS 12XL provides four ways to navigate to a destination: GOTO, MOB, TracBack, and route navigation. The most basic method of selecting a destination is the GOTO function, which lets you choose any stored waypoint as the destination and quickly sets a direct course from your present position.

To activate the GOTO function:

1. Press **GOTO**.
2. Select the waypoint you want to navigate to, and press **ENTER**.

Once a GOTO waypoint has been activated, the Compass Page or Highway Page will provide steering guidance to the destination until either the GOTO is cancelled or the unit has resumed navigating the active route (see pg 30).

To cancel an active GOTO:

1. Press the **GOTO** key.
2. Highlight 'CANCEL GOTO?', and press **ENTER**.

Man Overboard Function

The GPS 12XL's man overboard function (MOB) lets you simultaneously mark and set a course to a position for quick response to passing positions.

To activate the MOB mode:

1. Press **GOTO** twice. The GOTO waypoint page will appear with 'MOB' selected.
- 2 Press **ENTER** to begin MOB navigation.

The GPS 12XL will now guide you to the MOB waypoint until the MOB GOTO is cancelled. If you want to save the MOB waypoint, be sure to rename it because it will be overwritten the next time a MOB is activated.



Select a destination waypoint from the GOTO waypoint list.

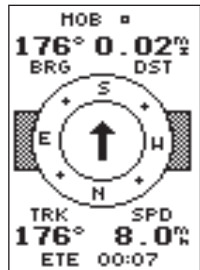

Once the MOB mode has been activated, steering guidance will be provided by the Compass or Highway Page. Activating another MOB will overwrite the previous MOB waypoint.

TracBack

**WARNING:**

Setting the track recording to OFF will disable the TracBack function.



Highlight 'TRACBACK?' and press ENTER to begin TracBack navigation.

TracBack Navigation

GARMIN's patented TracBack feature allows you to quickly retrace your path using the track log automatically stored in the receiver. This feature eliminates the need to mark waypoints along the way and manually create and activate a route back to where you began your trip. Three track recording options are available:

Off—no plot will be recorded.

Fill—a track plot will be recorded until track memory is full.

Wrap—a track plot will be continuously recorded, wrapping through the available memory (replacing the oldest data with new data).

To select a track log option:

1. Highlight the 'RECORD' field, press **ENTER**, select an option, and press **ENTER**.

Once a TracBack route is activated, it will lead you back to the oldest track log point stored in memory, so it's usually a good idea to clear the existing track log at the start of each trip.

To clear the track log and define a starting point for a TracBack route:

1. From the Map Page, press **ENTER**, highlight the 'TRACK SETUP' option, and press **ENTER**.
2. Highlight 'CLEAR LOG?', press **ENTER**, highlight 'Yes?', and press **ENTER**.

To activate a TracBack route:

1. Press **GOTO**, highlight 'TRACBACK?', and press **ENTER**.

Once the TracBack function has been activated, the GPS 12XL will take the track log currently stored in memory and divide it into segments called legs. Up to 30 temporary waypoints will be created to mark the most significant features of the track log in order to duplicate your exact path as closely as possible. These points will be indicated by a 'T001' number on the waypoint list, and by a 'T' symbol on the Map Page.

The active route page will appear, showing a route from your present position to the oldest track log point in memory. Steering guidance to each waypoint will be provided back to the starting point of your track log. Note: You may delete a TracBack waypoint from a route, but only if the route is not active.

Tips On the TracBack Feature

- Always clear your track log at the exact point that you want to go back to (trail head, truck, etc.).
- The 'RECORD' option on the track log setup page can be set to either the 'WRAP' or 'FILL' positions.
- There must be at least two track log points stored in memory to create a TracBack route.
- If there are not enough available waypoints in memory to create a TracBack route, you will be alerted with a 'waypoint memory full' message, and the receiver will use any available waypoints to create a TracBack route with an emphasis on the track log closest to the destination (the oldest track log point in memory).
- If the 'METHOD' option on the track log setup page is set to a time interval, the TracBack route may not follow your exact path. (Keeping the criteria set to automatic will always provide the most detailed TracBack route.)
- If the receiver is turned off or you lose satellite coverage during your trip, the TracBack route will simply draw a straight line between any point where coverage was lost and where it resumed.
- If the changes in direction and distance of your track log are complex, 30 waypoints may not be enough to accurately mark your exact path. The receiver will then assign the 30 waypoints to the most significant points of your track, and simplify segments with fewer changes in direction.
- To save a TracBack route, copy route 0 to an open storage route before activating another TracBack. Activating another TracBack or storage route will overwrite the existing TracBack route.
- Whenever a TracBack route is activated, the receiver will automatically erase any temporary waypoints that are not contained in routes 1-19. If there are temporary waypoints stored in routes 1-19, the receiver will create any new temporary waypoints using the first three-digit number available. (You can also quickly delete all temporary TracBack waypoints in memory by using the 'DELETE BY SYMBOL' method described on pg. 19.)

REFERENCE

TracBack

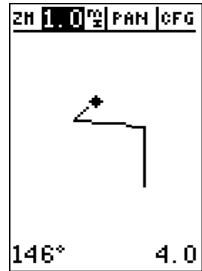

The TracBack feature will navigate your track log back to the oldest point in the receiver's memory.

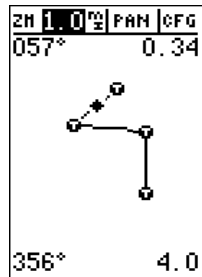

The track log will be divided into segments with temporary waypoints to create a route back to the beginning of the track log.

Route Navigation

The last form of navigating to a destination with the GPS 12XL is by creating a user-defined route. The route navigation feature lets you plan and navigate a course from one place to another using a set of pre-defined waypoints. Routes are often used when it's not practical, safe, or possible to navigate a direct course to a particular destination (e.g., through a body of water or impassable terrain).

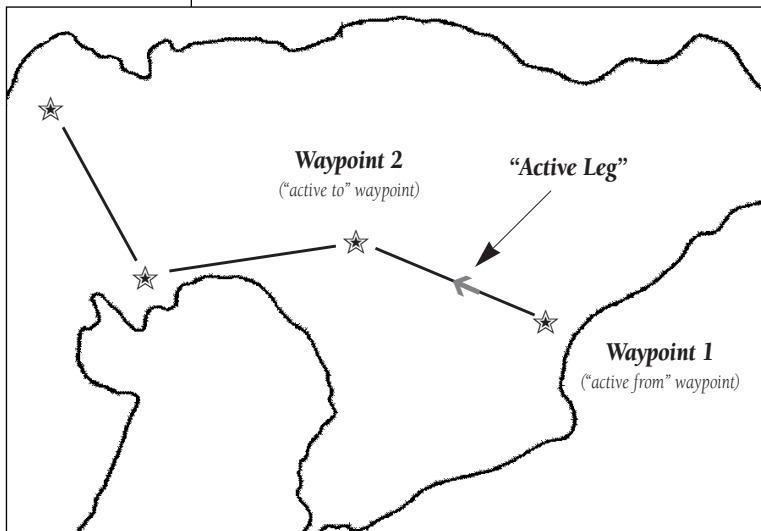

Routes are broken down and navigated in smaller segments called "legs". The waypoint you are going to in a leg is called the "active to" waypoint and the waypoint immediately behind you is called the "active from" waypoint. The line between the "active to" and the "active from" waypoint is called the "active leg".

Whenever you activate a route with the GPS 12XL, it will automatically select the route leg closest to your position as the active leg. As you pass each waypoint in the route, the receiver will automatically sequence and select the next waypoint as the "active to" waypoint.

Route Definition Page

ROUTE: 7			
HOME TO GAS			
NO	WAYPNT	DTK	DST
1	HOME	343'	2.1
2	CAMP	237'	3.0
3	BRIDGE	115'	1.5
4	TRAIL	056'	2.1
5	GAS	---	---
6	---	---	---
TOTAL DST			8.71
COPY TO: __			
CLR? INV? ACT?			

Function Prompts

The last form of navigating to a destination with the GPS 12XL is by creating a user-defined route. The GPS 12XL lets you create and store up to 20 routes of 30 waypoints each.

The route navigation feature lets you plan and navigate a course from one place to another using a set of pre-defined waypoints. Routes are often used when it's not practical, safe, or possible to navigate a direct course to a particular destination (e.g., through a body of water or impassable terrain).

The bottom of the route definition page features several 'function' fields which let you copy, clear, invert, or activate the displayed route. Routes 1-19 are used as storage routes, with route 0 always serving as the active route you are navigating. If you want to save a route that's currently in route 0, be sure to copy it to another open route, as it will be overwritten by the next route activation.

Routes can be copied, cleared, inverted, and activated through the route definition page.

To select the route definition page:

1. Highlight 'ROUTES' from the Menu Page, and press



The 'route number' field is displayed at the top of the page, with a 16-character 'user comment' field to the right. If no user comment is entered, the field displays the first and last waypoint in the route. The waypoint list on the left side of the page accepts up to 30 waypoints for each route, with fields for desired track and distance between legs. The total route distance is indicated below the waypoint list.

REFERENCE

Route Definition Page

MENU	
WAYPOINT	
WAYPOINT LIST	
NEAREST WPTS	
PROXIMITY WPTS	
ROUTES	
DIST AND SUM	
MESSAGES	
SYSTEM	
NAVIGATION	
INTERFACE	

Routes enable you to store and use groups of frequently used waypoints together.

ROUTE: 5			
HOME TO GAS			
NO	WAYPNT	DTK	DST
1	HOME	070'	2.3
2	LAKE	326'	1.9
3	TRAIL	183'	3.2
4	GAS	---	---
5	---	---	---
6	---	---	---
TOTAL DST			7.31
COPY TO: __			
CLR? INV? ACT?			

Enter each waypoint in the order you would like to navigate them. If you enter a waypoint not stored in memory, you'll need to define the position on the waypoint definition page.

Using Routes

ROUTE: 7			
JAMES TRAIL			
NO	WAYPNT	DTH	DST
1	-----	---	---
2	-----	---	---
3	-----	---	---
4	-----	---	---
5	-----	---	---
6	-----	---	---
TOTAL DST			0.00
COPY TO: --			
CLR? INV? ACT?			

You may use up to 16 characters to custom name a route. The default name will be the first and last waypoint in the route.

ROUTE: 5			
HOME TO GAS			
NO	WAYPNT	DTH	DST
1	HOME	070'	2.3
2	LAKE	326'	1.9
3	TRAIL	183'	3.2
4	GAS	---	---
5	-----	---	---
6	-----	---	---
TOTAL DST			7.31
COPY TO: --			
CLR? INV? ACT?			

To activate a route, highlight the 'ACT?' prompt and press ENTER.

Creating and Navigating Routes

To create a route from the route definition page:

1. Highlight the 'ROUTE:' field, and press **ENTER**.
2. Enter a route number, and press **ENTER**. (Only open routes will be available.)
3. Press **ENTER** to begin entry of a route comment.
4. Enter your comment, and press the **ENTER** key.
5. Enter the first waypoint of your route, and press **ENTER**. As you continue entering the rest of your waypoints, the list will automatically scroll down.

Whenever you activate a route, it will automatically select the route leg closest to your position as the active leg. As you pass each waypoint in the route, the receiver will automatically sequence and select the next waypoint as the active to waypoint.

Activating and Inverting Routes

After a route has been entered, it can be either activated in sequence or inverted from the route definition page. The process of activating or inverting a stored route takes a storage route (routes 1-19) and copies it into the active route (route 0) for navigation. The storage route is now no longer needed and will be retained in its original format under its existing route number.

This system allows you to have an active route that you may edit during navigation and save as an entirely new route from the original. You will have to copy the active route to an unused storage route to save it, since new route or TracBack activation overwrites route 0.

To activate a route:

1. From the route definition page, highlight the 'ROUTE:' field.
2. Enter the route number to be activated, and press **ENTER**.
3. Highlight 'ACT?', and press **ENTER**.

To activate a route in inverted order:

1. Follow the steps above, but select 'INV?', and press **ENTER**.

Active Route, Copying, & Clearing

Active Route Page

Once a route has been activated, the active route page will display the waypoint sequence of your route with the estimated time enroute (ETE) at your present speed and the distance to each waypoint. As long as you are navigating an active route, the active route page will become part of the main page sequence of the unit. The active route page will also allow you to change the 'ETE' field to display desired track (DTK) or estimated time of arrival (ETA) for each leg. You can also clear or invert the active route.

To display DTK or ETA for each leg:

1. Highlight 'ETE', and press **ENTER**.
2. Select 'DTK' or 'ETA', and press **ENTER**.

The active route page also allows you to clear (stop navigating) or invert the active route without using the route definition page.

To invert a route from the active route page:

1. Highlight 'INV?', and press **ENTER**.

To stop route navigation:

1. Select 'CLR?', and press **ENTER**.

Copying and Clearing Routes

The route definition page is also used to copy a route to another route number. This feature is useful when you make changes to the active (or TracBack) route and want to save the route in its modified form for future use.

To copy a route:

1. Highlight the 'route number' field, and press **ENTER**.
2. Select the route number to be copied, and press **ENTER**.
3. Highlight the 'COPY TO' field, and press **ENTER**.
4. Scroll through the available routes and select a destination route number. (Only open routes will be available.) Press **ENTER** to copy the route.

To clear a route from memory:

1. Highlight the 'ROUTE:' field, and press **ENTER**.
2. Enter the route number, and press **ENTER**.
3. Select 'CLR?', and press **ENTER**.
4. Highlight 'Yes?', and press **ENTER**.

ACTIVE ROUTE			
HOME TO GAS			
WAYPNT	ETE	DST	
HOME	---	---	---
LAKE	33:04	2.18	
TRAIL	01:01	4.05	
GAS	01:50	7.24	
-----	:	:	:
-----	:	:	:
-----	:	:	:
-----	:	:	:
-----	:	:	:
CLEAR? INVERT?			

Active Route Page

Whenever you have an active route, the active route page will appear in the primary page sequence after the Compass/Highway Page.

ROUTE: 5			
HOME TO GAS			
NO	WAYPNT	DTK	DST
1	HOME	070'	2.3
2	LAKE	326'	1.9
3	TRAIL	183'	3.2
4	GAS		
5	-----	---	---
6	-----	---	---
TOTAL DST			7.31
COPY TO: <input checked="" type="checkbox"/> ?			
CLR? INV? ACT?			

To copy a route, select an open storage route and press the ENTER key. If you select a route that is already used, you'll be alerted with a 'Route Full' message.

Editing Routes & On-Route GOTO's

ROUTE: 5			
HOME TO GAS			
NO	WAYPNT	DTH	DST
1	HOME		
2	LA		
3	TRAIL		
4	GAS		
5	-----	---	---
6	-----	---	---
TOTAL DST			7.31
COPY TO: ---			
CLR? INU? ACT?			

Use the on-screen menu to select the desired editing function.

ROUTE: 5			
HOME TO GAS			
NO	WAYPNT	DTH	DST
1	HOME	070'	2.3
2	LAKE	326'	1.9
3	TRAIL	183'	3.2
4	GAS		
5	-----	---	---
6	-----	---	---
TOTAL DST			7.31
COPY TO: ---			
CLR? INU? ACT?			

To edit or review a route waypoint from the active route page, highlight the desired waypoint and press ENTER.

Editing Routes

A route can be edited any time after its creation.

To edit a route from the active route page or the route definition page:

1. Select the waypoint you want to edit, and press **ENTER**.

An on-screen menu of editing choices will appear, with options for reviewing, inserting, deleting, or changing the waypoint field highlighted. This field contains the following options:

- **Review?**— reviews the waypoint's definition page
- **Insert?**— adds a new waypoint that precedes the selected waypoint
- **Remove?**— deletes a selected waypoint
- **Change?**— replaces the selected waypoint with a new waypoint

You may delete a waypoint from a route, but only if the route is not active. Note: Editing the original storage route will not affect route 0. If you want to save an edited version of route 0, save it to an open storage route.

On-Route GOTOs

At the beginning of this section, we mentioned that the GPS 12XL will automatically select the route leg closest to your position as the active leg. This will give you steering guidance to the desired track of the active leg. Note that the first waypoint selected as the destination waypoint will be the route leg closest to your present position. This may mean you're not navigating to the first waypoint in the active route—you may be navigating to the last. If you prefer to navigate a route out of sequence, you can perform an "on-route GOTO" from the active route page.

To perform an "on-route GOTO" from the active route page:

1. Highlight the desired route waypoint, and press **GOTO**.
2. Once the GOTO waypoint page appears with the waypoint highlighted, press **ENTER**.

Note that after you reach the on-route GOTO waypoint, the GPS 12XL will automatically resume navigating the rest of the route in sequence using the page you were on before performing a GOTO.

Selecting a User-Defined Navigation Page

Once you've selected a GOTO destination or activated a TracBack, MOB, or route, the GPS 12XL will provide graphic steering guidance to the destination with one of two navigation pages:

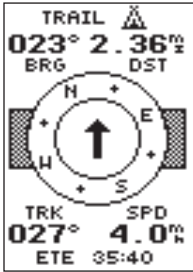

Compass Page

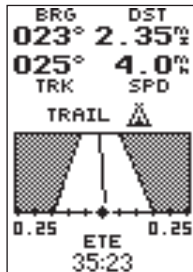

Highway Page

- The **Compass Page** (default) provides a directional pointer to the destination, with a rotating compass display to show your direction of travel. The Compass Page provides better steering guidance for car travel, hiking, or biking, where straight-line navigation usually is not possible.
- The **Highway Page** provides a graphic highway that shows your movement relative to the desired course, with an emphasis on your crosstrack error (the distance and direction you are off course). This page also features a course deviation indicator (CDI) (see pg. 34). The Highway Page is well-suited for water or off-road recreation where straight-line navigation is possible.

Both pages provide a digital display of the bearing and distance to the destination, and your current speed and track over the ground. You can switch to either Navigation Page at any time.

To select either Navigation Page:

1. Press **ENTER** from the existing Navigation Page, and **ENTER** again to change the page.

Navigation Pages

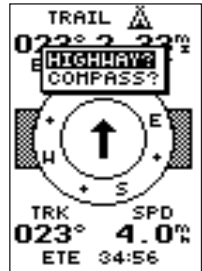

To switch the navigation page to the Compass Page, press ENTER twice.



To switch the navigation page to the Highway Page, press ENTER twice.

Navigation Pages

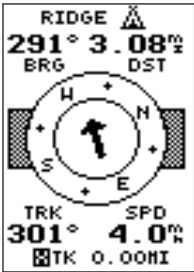

Use the user selectable field to customize the navigation pages.

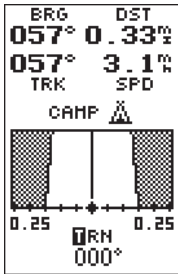

The turn option will show you the number of degrees you need to turn to head directly to your destination.

Selecting a User-Defined Navigation Page (cont.)

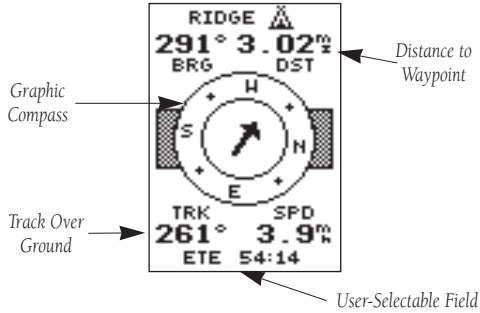

The 'ETE' field, located in the middle-bottom of both pages, is a user-selectable field that allows you to display a variety of navigation values for your trip.

To access the user-selectable field:

1. Highlight 'ETE', and press **ENTER**.
2. Use the keypad to scroll through the possible options.

The following data options are available for the Navigation Pages:

Estimated Time Enroute (ETE)— the time left to your destination based on your present speed and track.

Estimated Time of Arrival (ETA)— the time of day of your arrival at a destination, based on current ground speed and track.

Course to Steer (CTS)— the bearing which will give you the most efficient way to stay on course to your destination.

Crosstrack Error (XTK)— the distance you are off the desired course in either direction. This field will give you a digital representation of the CDI scale.

Velocity Made Good (VMG)— the speed you are traveling toward the destination.

Turn (TRN)— the amount of correction in degrees needed to travel directly to the destination.

Using the Compass Page

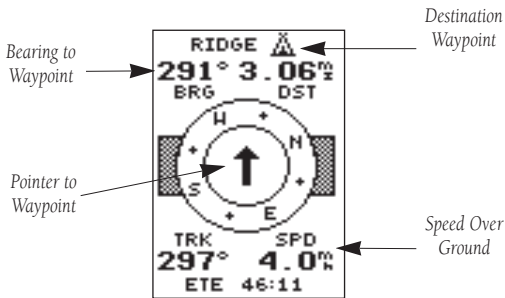

The Compass Page provides better steering guidance than the Highway Page for travel at slower speeds (ex. walking) and for travel with many directional changes.

The bearing (BRG) and distance (DST) to the waypoint are displayed at the top of the page, below the destination waypoint name. The distance displayed is the straight-line distance from your present position to the destination waypoint. The bearing indicates the exact compass heading from you to the destination.

The middle of the page features a rotating “compass ring” that shows your course over ground while you are moving (track up orientation), with a pointer arrow to the destination displayed in the center. The arrow shows the direction of your destination from the direction you are moving. For instance, if the arrow points up, you are going directly to the waypoint. If the arrow points any direction (left, right, down, etc.), turn toward the arrow until it points up. Then continue in that direction.

The bottom of the page shows your track (TRK), speed (SPD), and a user-selectable field for ETE, ETA, CTS, XTK, VMG, or TRN.

When you are one minute away from your destination (based on your current speed and track over ground), the GPS 12XL will alert you with a flashing on-screen message box.

REFERENCE

Compass Page

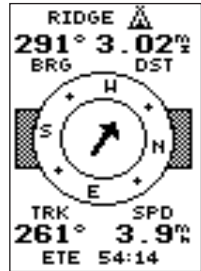

In this example, the Compass Page indicates that you are traveling in a west (261 degrees) direction and the destination waypoint is north (291 degrees) of your current direction of travel.

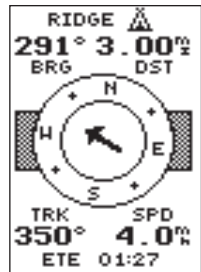

In this example, the Compass Page indicates that you are traveling in a north (350 degrees) direction and the destination waypoint is west (291 degrees) of your current direction of travel.

REFERENCE

Highway Pages

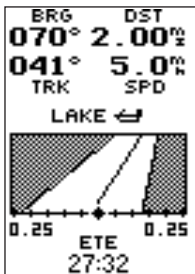

In this example, the Highway Page indicates that you are off course to the left. Steer right to get back on course. Notice the highway always shows the direction to turn. If the highway leads straight up the page, you should continue in your current direction.



If you get too far off course, a message box will appear to indicate what course to steer to get back on course most efficiently.

Using the Highway Page

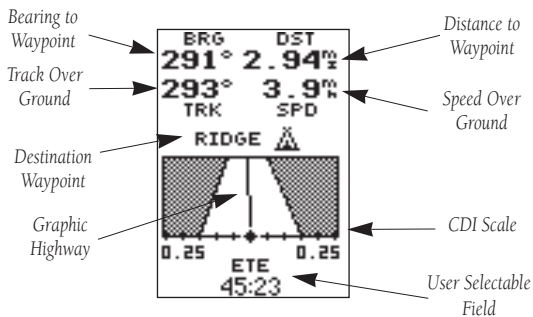

The GPS 12XLs Highway Page provides graphic steering guidance to a destination waypoint, with a greater emphasis on the straight-line desired course and the distance and direction you are off course. The bearing and distance to a waypoint - along with your current track and speed - are displayed at the top of the screen.

As you head toward your destination, the middle of the screen provides visual guidance to your waypoint on a moving graphic “highway.” Your present position is represented by the diamond in the center of the course deviation scale. The line down the middle of the highway represents your desired track. As you navigate toward a waypoint, the highway will actually move—indicating the direction you’re off course—relative to the position diamond on the CDI scale. When the highway is pointing straight up the screen, the waypoint is directly ahead. If the destination waypoint is to the left, the top of the highway will lead to the left, and vice versa. To stay on course, simply steer in the direction the highway leads (left or right) until the highway leads straight up the page.

If you do get off the desired course by more than 1/5th of the selected CDI range, the exact distance you are off course will be displayed where the CDI scale setting normally appears. If you get too far off course (the highway has disappeared), a message box will appear to indicate what course to steer to get back on course. (For information on how to set this scale, see pg. 44.) As you approach a waypoint, a horizontal “finish line” will move toward the bottom of the highway. When the finish line reaches the CDI scale, you’ve arrived at your destination.

Map Page

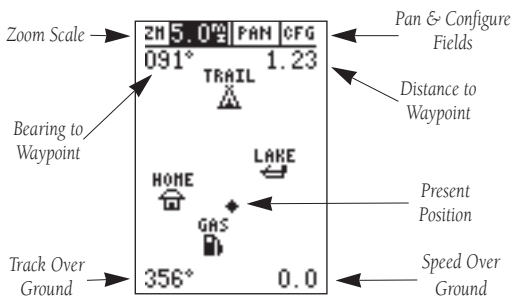

The Map Page shows your position and surroundings, and provides you with a target cursor that lets you pan ahead to nearby waypoints, determine the distance and bearing to a map position, and mark new waypoints while you navigate. The Map Page is broken down into two sections: control fields and map section.

The zoom function, panning control, and configuration fields are located at the top of the screen. The zoom function uses 12 selectable zoom ranges from 0.2 to 320 miles or 0.5 to 600 km. (Using the zoom, panning, and configure fields will be addressed in the next section.)

The map portion of the page displays your present position as a diamond icon, with your track and/or route displayed as a solid line. Nearby waypoints are represented as squares, with the waypoint name also listed. You may select which of these features are shown through the map setup submenu page (see pg. 38-39 for more information).

The four corners of the Map Page are used to display various navigation data, including the bearing and distance to a destination waypoint and your current track and speed over the ground. The two fields at the top corners of the map show your bearing and distance to one of three selectable destinations: an active destination waypoint, a highlighted on-screen waypoint, or the panning target crosshair. If you are not navigating to a waypoint or using the panning function, the top data fields will not be displayed. Your current track and speed are shown at the bottom corners of the display.

REFERENCE

Map Page

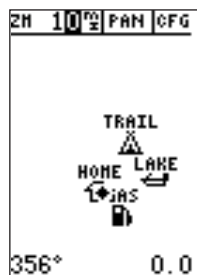

Note: A map scale represents the distance shown from the bottom to the top of the Map Page. For example, when viewing the 10 mile scale, the distance represented between the top of the screen and bottom is 10 miles.

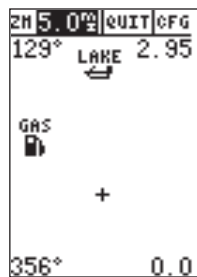

The four corners of the Map Page are used to show your course, speed, and distance to either a cursor or a destination waypoint.

Zooming, Panning, & Configuring

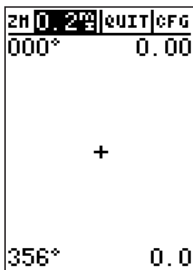

A crosshair will appear when you activate the pan function. The distance and direction of the crosshair from your current position will be shown in the upper corners of the Map Page.

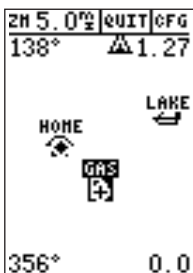

On-Screen Pointing

The crosshair will “snap” to displayed waypoints, which allows you to quickly review or go to the selected waypoint right from the Map Page.

Zooming, Panning, and Configuring

There are four main functions you can perform from the Map Page— zooming, pointing, panning, and configuring (changing the map and track setup). Each of these functions has its own “field”, which may be selected and activated for use. Whenever the Map Page first appears, the zoom field (at the top left) is always highlighted. The map has 12 map scales which are selected through the zoom function field.

To select a zoom scale:

1. Use the arrow keypad to highlight the zoom field.
2. Press the **ENTER** key to begin range selection.
3. Select a range scale and press **ENTER**.

The second function field on the Map Page is the pan field, located at the top middle of the screen. The pan function allows you to move the map with the four arrow keys to view areas outside the current map.

To activate the pan function:

1. From the zoom field, highlight the pan field.
2. Press the **ENTER** key to activate the pan function.
3. Use the arrow keys to move the map in any direction.

As you begin to move the map, a crosshair (plus sign) will appear. This crosshair will now serve as a target marker for the moving map. The distance and bearing to your destination will now be replaced by the distance and bearing from your present position to the target crosshair.

When you pan around the map, you'll notice the target crosshair will “snap” to on-screen waypoints and highlight the waypoint name. Once a waypoint name is highlighted, you can either review its waypoint definition page or waypoint display options, or execute a GOTO function right from the Map Page.

To review the waypoint definition page for a highlighted waypoint:

1. Press **ENTER** while the waypoint is highlighted.

Waypoint Display & Marking Cursor

Zooming, Panning, and Configuring (cont.)

From the waypoint definition page, you can also define how each individual waypoint is displayed on the map. The GPS 12XL displays waypoints as a name with a corresponding symbol (e.g., “nearest fuel” and a gas pump symbol), a symbol only (e.g., a fish symbol), or a 16-character comment and corresponding symbol (e.g., “great view” and the camp site symbol). The waypoint name has a six character limit while the “comment” field has a 16-character limit, and there are 16 individual waypoint symbols available.

To select a waypoint display option:

1. Highlight the “symbol” field (to the right of the name field), and press **ENTER**.
2. Move the cursor to the ‘DISPLAY’ field, and press **ENTER**.
3. Select a display option, and press **ENTER** to select one of the following display options: ‘NAME WITH SYMBOL,’ ‘SYMBOL ONLY,’ or ‘COMMENT WITH SYMBOL.’
4. Press **ENTER** to confirm the ‘DONE?’ prompt.
5. Press **ENTER** again (on the waypoint definition page) to return to the Map Page.

The last function you can perform with a waypoint highlighted on the Map Page is a GOTO directly to the waypoint.

To go to a waypoint highlighted on the Map Page:

1. Press **GOTO**.
2. Press **ENTER** to confirm the GOTO waypoint page.

Using the Cursor to Mark and Go to Waypoints

During panning, the crosshair represents a target position right on the Map Page, with the range and bearing to the target displayed at the top corners of the screen. You can also use the target crosshair to mark a new waypoint position or as a GOTO destination right from the map field.

To mark the target crosshair as a new waypoint:

1. Press **MARK**.
2. Enter a name and/or route number, and press **ENTER**.



You may custom tailor the Map Page to show waypoints by any of three options.

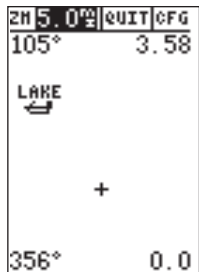

Marking a Cursor Position

To mark a new waypoint with the crosshair, simply pan to the desired position and press the MARK key.

Using Cursor & Map Setup

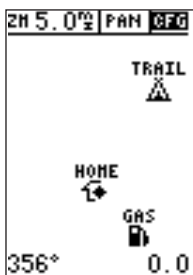

The 'CFG' field gives access to the map setup and track setup pages, right from the Map Page.



The Map Page's default screen orientation is track up. "Track Up" means that your current direction of travel is always up (or towards the top of) the screen. It can also be set for north up or desired track up orientation.

Using the Cursor to Mark and Go to (cont.)

You can also use the target crosshair as an instant GOTO destination. This feature is similar to the MOB mode, and will allow you to mark and instantly set a course for a new waypoint called 'MAP'.

To go to the target crosshair:

1. Press **GOTO**, and press **ENTER**.

To save the MAP waypoint, be sure to rename it because it will be overwritten with the next GOTO.

To stop the panning function:

1. Press **QUIT**.

Accessing Map Setup/Track Setup Windows

You can access two additional pages—the map setup page and the track setup page—by highlighting the 'CFG' field at the top right of the Map Page, and pressing **ENTER**. The map setup and track setup window will appear, ready for you to select one.

To select map setup or track setup:

1. Highlight either option, and press **ENTER**.

Map Setup Page and Orientation

The map setup page lets you select the Map Page and satellite sky view (see pg. 38) orientation, as well as specify what items are displayed. The Map and Satellite Pages may be oriented to 'NORTH UP,' 'TRACK UP' (the direction of current travel), or 'DTK UP' (desired track up, or the direction of travel to stay on course). The default setting is track up.

To change the map orientation:

1. Highlight the 'map' field, and press **ENTER**.
2. Select the desired orientation, and press **ENTER**.

Note: Selecting the 'DTK UP' option will set the satellite sky view to track up orientation.

The rest of the map setup page lets you specify what items are displayed or plotted on the Map Page by selecting 'YES' or 'NO' in the appropriate field.

- 'Rings'—displays the three present position range rings on the map.
- 'Route'—plots the straight-leg lines between waypoints of an active route and displays all route waypoint names.

Map & Track Setup

Map Setup Page and Orientation (cont.)

- 'Nearest'— shows the nine nearest waypoints to your position (black diamond) on the map.
- 'Names'— displays the waypoint name for the nine nearest waypoints.
- 'Track Log'— displays and plots track points on the map.

To turn a map item on or off:

1. Highlight 'YES' or 'NO' for the specific map item, and press **ENTER**.

Track Setup Page

The track setup page lets you manage the GPS 12XL's track log data. You can also select whether to record a track log and define how it is recorded.

To turn the track log on or off:

1. Highlight the 'RECORD' field, and press **ENTER**.
2. Select 'OFF, FILL, or WRAP', and press **ENTER**. (Note: Turning the track recording off will prevent using TracBack).

Track Method

The stored track method determines how often positions are stored in the track log. The default setting is automatic, which will store a track based on resolution. This setting gives the most efficient use of track memory and provides the best TracBack route.

To change the method to record points based on a specific time interval:

1. Highlight the 'METHOD' field, and press **ENTER**.
2. Select 'TIME INTERVAL', and press **ENTER** twice.
3. Enter hours, minutes, and seconds, and press **ENTER**.

Track Log Display

The track log option sets the number of points the unit will attempt to display on the Map Page. The default setting of 250 points provides good resolution with minimal screen clutter. The maximum setting is 1024 points. Once you've reached the maximum number of track points, the older points will be lost as new points are added. Note that adjusting the track points displayed will not affect whether the receiver records a track log or the ability to create a TracBack route.



Use the track setup page to control the way the GPS 12XL manages your track log.



Entering a time interval in to the track recording criteria will plot your position points further apart than they would be in the 'Automatic' setting. This will increase the distance you can travel without using up your track log, but will greatly reduce the effectiveness of TracBack.

Track Log & Distance/Sun Calculation



Clear the track log any time your screen gets cluttered or to make more room to store points to be used for a TracBack.

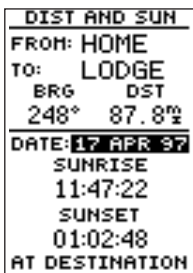

The GPS 12XL will calculate the sunrise and sunset times of any stored waypoint or your present position. To calculate, enter the date and year and press ENTER.

Managing and Clearing the Track Log

The rest of the track setup window displays the percentage of available memory currently used to store track log data, as well as function fields to clear the track log memory and activate the TracBack feature.

To clear the track log:

1. Highlight 'CLEAR LOG?', and press **ENTER**.
2. Highlight 'Yes?', and press **ENTER**.

Note: It's a good idea to clear the track log at the end of the trail head, etc., in order to make the best use of the TracBack feature.

Menu Page

The GPS 12XLs Menu Page provides access to additional pages (submenus) that are used to select and customize operation and navigation setup. These eight pages are divided into categories by function. We've already gone over the waypoint and route management pages in their respective sections. Let's review the rest of these pages in the order they appear on the Menu Page.

To select a submenu page from the Menu Page:

1. Highlight the page, and press **ENTER**.
2. To return to the Menu Page, press **QUIT**.

Distance and Sun Calculations

The distance and sun calculation page will give you the distance and bearing between any two waypoints or between your present position and a waypoint. It will also calculate the sunrise and sunset (in local time) for a particular date at either your present position or any stored waypoint.

To perform a distance and sun calculation:

1. Highlight the 'FROM' field, enter the desired waypoint, and press **ENTER**.
2. Highlight the 'TO' field, enter the destination waypoint, and press **ENTER**.
3. The 'DATE' field will become highlighted. Enter the date you'll arrive at your destination, and press **ENTER**.

If you haven't marked your present position as a waypoint or you leave the 'TO' field blank, the sunrise and sunset at your present position will be shown.

Date & Time Setup

System Setup

The system setup page is used to select the operating mode, time offset, and screen preferences. The GPS 12XL has two operating modes:

- **Normal Mode** operates the unit at maximum performance, and provides battery life of up to 12 hours on alkaline batteries.
- **Simulator Mode** allows you to operate the unit without acquiring satellites, and is ideal for practicing or entering waypoints and routes while at home.

To select an operating mode:

1. Highlight the 'MODE' field, and press **ENTER**.
2. Select a mode, and press **ENTER**.

Date and Time Setup

The date and time is located directly below the mode field. Note: Date and time information is derived from the GPS satellites and cannot be changed by the user. Because the time shown is UTC (Greenwich mean time) time, you will need to enter a time offset to display the correct local time for your area. To determine the time offset for your area, note your position and refer to the chart in Appendix C.

To enter the time offset:

1. Highlight the 'OFFSET' field, and press **ENTER**.
2. Enter the time offset, and press **ENTER**.

Note: Move the cursor to the left to change the plus or minus sign.

Time Format

The time display shown on the system setup and Position Pages may be set to display the time in a 12- or 24-hour format.

To select the time format:

1. Highlight the 'HOURS' field, and press **ENTER**.
2. Select 12- or 24-hour display, and press **ENTER**.

SYSTEM SETUP
MODE: Normal?
DATE 01 MAY 97
TIME 11:19:55
OFFSET: +00:00
HOURS: 24
CONTRAST: ████████
LIGHT: 15 SEC
TOUR: MSG, KEY

The GPS 12XL's two operating modes are accessed through the system setup submenu.

SYSTEM SETUP
MODE: Normal
DATE 01 MAY 97
TIME 11:20:34am
OFFSET: -08:00
HOURS: 12
CONTRAST: ████████
LIGHT: 15 SEC
TOUR: MSG, KEY

To display the correct local time, you must enter the appropriate offset from the chart at the end of Appendix C.

Screen Contrast & Backlighting

SYSTEM SETUP
MODE: Simulator
DATE 01 MAY 97 TIME 11:44:17am OFFSET: -02:00 HOURS: 12
CONTRAST: ██████
LIGHT: <input checked="" type="checkbox"/> STAY ON
TONE: MSG, KEY

The "Stay On" setting will keep your backlighting on continuously. However, this will significantly reduce your battery life.

SYSTEM SETUP
MODE: Normal
DATE 01 MAY 97 TIME 09:21:18am OFFSET: -02:00 HOURS: 12
CONTRAST: ██████
LIGHT: 15 SEC
TONE: <input checked="" type="checkbox"/> MSG ONLY



The tone setting has three options to customize it to your preference.

Screen Contrast

SYSTEM SETUP
MODE: Normal
DATE 01 MAY 97 TIME 09:20:59am OFFSET: -02:00 HOURS: 12
CONTRAST: ██████
LIGHT: 15 SEC
TONE: MSG, KEY

The GPS 12XL has adjustable screen contrast controlled by an on-screen bar scale.

To set the screen contrast:



1. Highlight the 'CONTRAST' field, and press .
2. Adjust the bar scale to the desired contrast, and press .

Note: The screen contrast can also be adjusted by pressing the rocker keypad while on the Satellite Page (see pg. 11).

Backlighting Timer

The screen backlight timer is adjustable for 15, 30, 60, 120, or 240 seconds. The timer also may be set to the 'Stay On' setting for continuous use. Whenever backlighting is on, a bulb icon will appear on the Satellite Page.



To set the backlight timer:

1. Highlight the 'light timeout' field, and press .
2. Select the desired setting, and press .
3. To turn lighting on and off, press the  briefly.

Tone Setting

The GPS 12XL allows you to choose a tone for messages only, messages and keystrokes, or no tone setting at all.

To set the tone:

1. Highlight the 'TONE' field and press the  key.
2. Select the desired setting and press .

Navigation Setup

Navigation Setup

The navigation setup submenu page is used to select units of measurement for position formats, map datums, CDI scale, units, and heading information.

Position Formats

The default position format for the GPS 12XL is latitude and longitude in degrees and minutes (hddd°mm.mmm'). You may also select degrees, minutes and seconds (hddd°mm'ss.s"); degrees only (hddd.dddd°); UTM/UPS coordinates; or British, German, Irish, Maidenhead, Swedish, Swiss, or Taiwan, or User grid formats.

To select a position format:

1. Highlight the 'POSITION FRMT' field, and press **ENTER**.
Select the desired setting, and press **ENTER**.

User Grid Position Format

The user grid option lets you create a user defined position format by establishing factors such as longitude of origin, scale, and false Easting or Northing.

To define a user grid:

1. Select 'User Grid', and press **ENTER**. Enter values for longitude origin, scale, and false Easting and Northing, and press **ENTER**. Highlight 'SAVE?', and press **ENTER**.

Map Datums

The 'MAP DATUM' field comes with a WGS 84 default setting. Although 106 total map datums are available for use (see Appendix D for map datums), you should only change the datum if you are using maps or charts that specify a different datum than WGS 84.

To select a map datum:

1. Highlight the 'MAP DATUM' field, and press **ENTER**.
2. Select the desired setting, and press **ENTER**.

NAV SETUP	
POSITION FRMT:	hddd°mm'ss.s"
MAP DATUM:	WGS 84
CDI SCALE:	±0.25
UNITS:	Statute
HEADING:	Auto Mag E004

The position format may be set to display your choice of many formats. Note: degree and minutes is the default setting.

NAV SETUP	
POSITION FRMT:	hddd°mm.mmm'
MAP DATUM:	WGS 84
CDI SCALE:	±0.25
UNITS:	Statute
HEADING:	Auto Mag E004

The default map datum covers world-wide navigation. However, if you are using a paper map or chart which uses a different map datum than WGS 84, then you may wish to switch to that datum.

Datums, CDI Settings, & Measurement

NAV SETUP	
POSITION FRMT:	hddd*mm. mmm'
MAP DATUM:	User
CDI SCALE:	±0.25
UNITS:	Statute
HEADING:	Auto Mag E004

The user datum feature allows you to define the earth model used to calculate position coordinates.

WARNING: Incorrect entries may result in substantial position errors.

NAV SETUP	
POSITION FRMT:	hddd*mm. mmm'
MAP DATUM:	WGS 84
CDI SCALE:	±0.25
UNITS:	Statute
HEADING:	User Mag:E000

To enter a user-defined magnetic variation, select the 'User Mag' option and enter the desired direction and value.

Map Datums (continued)

To define a user datum:

1. Highlight the 'MAP DATUM' field, and press **ENTER**.
2. Scroll through the map datum options until 'User' appears, and press **ENTER**.
3. Enter values for 'DX', 'DY', 'DZ', 'DA', and 'DF' using the rocker keypad, and press **ENTER**.
4. Highlight 'SAVE?', and press **ENTER**. The setup menu will reappear.

CDI Scale Settings

The course deviation indicator (CDI) field lets you select the +/- range of the CDI bar scale on the Highway Page. Three scales are available: +/- 0.25 (default), 1.25, and 5.0 miles or kilometers. Note: This CDI value represents the full deflection of scale to either side.

To enter a CDI scale setting:

1. Highlight the 'CDI SCALE' field, and press **ENTER**.
2. Select the desired setting, and press **ENTER**.

Units of Measure

The GPS 12XL lets you select statute (default), nautical, or metric units of measure for all "speed" and "distance" fields.

To change the unit of measure:

1. Highlight the 'UNITS' field, and press **ENTER**.
2. Select the desired unit of measure, and press **ENTER**.

Magnetic Heading Reference

The GPS 12XLs heading information can be displayed referencing magnetic north (automatic or user-defined), true north, or calculated grid headings. The default setting is automatic magnetic north, which is suitable for most applications.

To select a heading reference:

1. Highlight the 'HEADING' field, and press **ENTER**.
2. Select the desired heading preference, and press **ENTER**.

To enter a user-defined magnetic heading:

1. Select 'User Mag' and press **ENTER**.
2. Enter the degrees and direction of magnetic variation, and press **ENTER**.

Interface Setup & DGPS

Interface Setup

The GPS 12XL's interface page lets you specify the formats for connecting external devices. There are six options: GRMN/GRMN, None/None, RTCM/None, RTCM/NMEA, NMEA/NMEA, and None/NMEA. Each option lists the input format first, followed by the output format.

To select I/O format:

1. Highlight the I/O field, and press **ENTER**.
2. Select the desired setting, and press **ENTER**.

The GRMN/GRMN setting is a proprietary format that lets you exchange information such as waypoints, routes, and track logs between two GARMIN GPS units or a GARMIN GPS and a PC. There are eight data transfer options: send alm, send wpt, send trk, send rte, request alm, request wpt, request trk, request rte.

To select a transfer option:

1. Highlight 'HOST', and press **ENTER**.
2. Select a desired setting, and press **ENTER**.

To disable all interfacing capabilities, select the None/None setting. If you want to output NMEA data without any differential input capability, select 'None/NMEA.'

DGPS Interface

The last two format settings allow the differential-ready GPS 12XL to accept RTCM DGPS corrections in RTCM 104 version 2.0 format. Using DGPS corrections will improve receiver accuracy to 1-5 meters, regardless of errors induced by the government's Selective Availability (SA) program. Two RTCM options are available: RTCM/NONE, which allows connection to a beacon receiver with no output capability; and RTCM/NMEA, which allows DGPS input and NMEA output.

Once a RTCM setting has been selected, the GPS 12XL will either automatically try to tune the last frequency and bit rate you selected or will switch to the default frequency of 304.0 kHz with a bit rate of 100 bps if no previous beacon has been tuned. You may also enter your own frequency and bit rate if desired.

```

INTERFACE
[ ]TCM/NONE?
HOST
WAITING...

  ___ of ___
    PACKETS
  
```

Choose an interface option based upon what equipment you are using to transfer information.

```

INTERFACE
[ ]TCM/NONE

130 baud
-----
BEACON RECUR
FREQ  ___KHz
RATE   25bps
DIST   ___m
SNR    ___dB
No Status
  
```

Once the RTCM option is selected the GPS 12XL will automatically tune itself or display a default frequency.

DGPS Interface

```

INTERFACE
-----
RTCM/NONE

600 baud

BEACON RECVR
FREQ  _ _ _ _ _ KHz
RATE   25bps
DIST   _ _ _ m
SNR    _ _ dB
No Status
  
```

The selectable baud rate is available for all RTCM interface options.

```

MESSAGES
-----
No DGPS
Position

PRESS PAGE
  
```

Alert messages will signal any problems with DGPS operation.

DGPS Interface (continued)

To enter a DGPS beacon frequency:

1. Highlight the 'FREQ' field, and press **ENTER**.
2. Enter the desired frequency, and press **ENTER**.
3. Highlight the 'RATE' field, and press **ENTER**.
4. Select the desired transmission rate, and press **ENTER**.

When the GPS 12XL is receiving DGPS corrections from the GBR 21, the 'BEACON RECVR' section of the I/O setup page will display the beacon frequency and signal strength, as well as the distance from the transmitter to the beacon receiver. At the bottom of the beacon receiver field, a status message will keep you informed of DGPS activity:

- A 'Tuning' message will be displayed while a beacon signal is being tuned.
- Once the beacon signal has been tuned, a 'Receiving' message will be displayed.
- If a beacon signal is tuned and no corrections are being received, a 'No Data' message will be displayed.
- If a beacon signal cannot be tuned, a 'No Status' message will be displayed.

The message page will alert you to any problems relating to DGPS operation. You may also monitor the DGPS status from the status field on the interface page. The GPS 12XL will display one of three alert messages concerning DGPS operation:

No DGPS Position— there is not enough data available to compute a DGPS position.

No RTCM Input— the beacon receiver is not properly connected or the baud rates do not match.



RTCM Input Failed— DGPS data was being received but has been lost.

Navigation Simulator

Navigation Simulator

The GPS 12XL's simulator mode lets you practice all aspects of its operation without active satellite acquisition. You can plan and practice trips, enter new waypoints and routes, and save them for use during normal operation.

To activate the simulator:

1. From the Menu Page, highlight 'SYSTEM SETUP', and press .
2. Highlight the 'MODE' field, and press .
3. Select 'Simulator?', and press .

Once the simulator mode has been activated, use the Position, Compass, or Highway Page to set your speed and track by highlighting the appropriate field, entering the desired value, and pressing . You may also enter a new position if you desire (from the Position Page).



The GPS 12XL does not track satellites in simulator mode. Although you can create and save waypoints and routes while using the simulator mode, never attempt to use the simulator mode for actual navigation.



Select the simulator mode from the operation mode choices and press ENTER. You may return to normal operation by changing the operation mode or by turning the unit off.

Initialization



Welcome Page

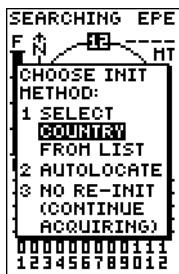

The EZinit prompt will automatically appear if the receiver needs to be initialized. The prompt may also appear during normal use if the antenna is shaded.

Initializing Your GPS 12XL for First-Time Use

The GPS 12XL typically acquires a position so fast that initialization is completed automatically. However, initialization will be necessary for the following:

- After memory loss
- When the receiver has been moved more than 500 miles with the power off.

Additionally, it may be necessary to initialize the unit the first time you use it, if it does not acquire a fix in a few minutes.

The receiver is shipped from the factory in AutoLocate™ mode, which enables the GPS 12XL to determine its location anywhere in the world. To speed up the initialization process, we recommend using the graphic initialization described below, which will usually provide a fix in a few minutes.

To turn the GPS 12XL on:

1. Press and hold  until the receiver turns on.

The welcome page will be displayed while the unit conducts a self test.

Once testing is complete, the welcome page will be replaced by the Satellite Page, with the EZinit prompt ready for you to select one of two initialization methods:

- **Select Country**—allows you to initialize the receiver by selecting your present position from a list of countries in the GPS 12XL's internal database. This usually provides a position fix in a few minutes.
- **Autolocate™**—allows the GPS 12XL to initialize itself and calculate a position fix without knowing your present position. This usually provides a position fix in 3-5 minutes.

If the EZinit prompt has not automatically appeared on the Satellite Page:

1. Press the  key.

Note: If the EZinit prompt ever appears *after* you have initialized the receiver (due to the antenna's view of satellites being obstructed by trees, etc.), highlight the 'NO RE-INIT' selection with the arrow keypad and press .

Initialization

To initialize the receiver:

1. If the 'COUNTRY' option is not highlighted, press the ▼ key repeatedly to move the field highlight to the 'COUNTRY' option.
2. Press the **ENTER** key.
3. Use the ▼ key to scroll through the list options until the country of your present position appears.
4. Use the ▲ key to highlight the country/state/region you're in. If the country you're in is not listed, select another country within 500 miles of your present position.
5. Press **ENTER** to finish.

The GPS 12XL will now begin searching for the appropriate satellites for your location and should acquire a position within 3-5 minutes. You can verify that you have acquired a position by watching the Satellite Page transition to the Position Page (provided you haven't pressed any other buttons) or by looking for a '2D NAV' or '3D NAV' status at the top-left corner of the Satellite Page.

Initialization Troubleshooting

If you have trouble initializing the receiver or acquiring a position, check the following:

- **Does the unit have a clear view of the sky?**

If there are large buildings or mountains nearby, or if there is heavy tree cover, the receiver may not be receiving enough satellite signals to calculate a position.

- **Have you selected the right country/state/region from the EZinit list?**

Check for the correct approximate lat/lon on the Position Page, or reselect the appropriate country from the list to restart the initialization.

- **Have you moved more than 500 miles from the last calculated position with the receiver off?**

Reinitialize the receiver, selecting the country/state/region of your new location from the EZinit list.

Your unit should now be initialized.

COUNTRY LIST
Turks Caicos Isl
Tuvalu
Uganda
Ukraine
U A Emirates
UK-England
UK-Ireland
UK-Scotland
UK-Wales
USA-AR

Use the arrow keypad to highlight the country, region, or state of your present position from the list and press ENTER. If the country is not listed, select the closest country instead.

Specifications & Wiring

Never attempt any repairs yourself. To protect your GPS 12XL, keep it in its carrying case when not in use, and never allow gasoline or other solvents to come into contact with the case. Clean the case and lens with a soft cloth and a household window cleaner.

PHYSICAL

Case:	waterproof*
Size:	14.6 x 5.1 x 3.4 cm
Weight:	Approx 9.5 ounces (269g) w/ batteries
Temperature Range:	5° to 158°F (-15° to 70°C)

PERFORMANCE

Receiver:	12 parallel channel, differential-ready
Acquisition Time:	Approx. 15 seconds (warm start) Approx. 45 seconds (cold start) Approx. 5 minutes (AutoLocate™)
Update Rate:	1/second, continuous
Position Accuracy:	1-5 meters (3-17 ft.) with DGPS corrections** 15 meters (49 ft.) RMS***
Velocity Accuracy:	0.1 knot RMS steady state
Dynamics:	6g

POWER

Input:	Four 1.5 volt AA batteries or 10-32 vDC
Power Consumption:	1 watt
Battery Life:	Up to 12 hours (with 4 AA batteries)
Internal Backup:	lithium battery

NOTE: Alkaline batteries lose a significant amount of their capacity as temperature decreases. If you're using the GPS 12XL in below freezing temperatures, use lithium batteries for longer battery life. Extensive use of screen backlighting will significantly reduce battery life.

Specifications subject to change without notice.

* Meets IEC (European Community Specification) 529 IPX7 for protection against immersion for 30 minutes at a depth of 1 meter.

** With optional DGPS Input.

*** Subject to accuracy degradation to 100m 2DRMS under the US DOD-imposed Selective Availability Program.

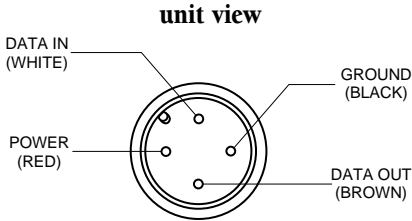

Three optional cables are available to connect the GPS 12XL to an external power source or interface with another unit or PC:

- Cigarette Lighter Adapter— Allows connection to a 12-volt DC cigarette lighter plug. Part No. 010-10085-00.
- Data Transfer Cable— Allows data transfer between GARMIN GPS units. The GPS 12XL is compatible with the following units: GPS 38/40/45/45XL, GPS II/II plus, GPS 12, and GPS 12XL. Information that can be transferred includes the almanac, waypoints, routes, and tracklog. *However*, waypoint symbols are only transferrable from or to units that support waypoint symbols such as the GPS II plus, GPS 12, and GPS 12XL software version 3.01 or later. Part No. 010-10142-00.
- PC Kit Interface Cable— PC interface cable with 9-pin 'D' serial data connector. Part No. 010-10141-00.

The following interface formats are supported by the GPS 12XL for driving three NMEA devices:

NMEA 0180

NMEA 0182

NMEA 0183 version 1.5

Approved sentences:

GPRMB, GPRMC, GPWPL

Proprietary sentences:

PGRMM (map datum),
PGRMZ (altitude), PSLIB
(beacon rec. control)

NMEA 0183 version 2.0

Approved sentences:

GPGGA, GPGSA, GPGSV,
GPRMB, GPRMC, GPRTE,
GPWPL

Proprietary sentences:

PGRME (estimated error),
PGRMM (map datum), PSLIB
(beacon receiver control)

DGPS corrections are accepted on
RTCM-104 v. 2.1 format.

Messages & Time Offsets

The GPS 12XL uses a flashing on-screen message indicator to alert you to important information. Whenever the message indicator appears, press PAGE to view the message page. There are two types of messages: temporary alerts and condition alerts. Temporary alerts are cleared from the message page after viewing, while condition alerts remain until the condition has been resolved. Pay careful attention to all messages for your own safety.

Active WPT Can't be Deleted—You have attempted to change the “active to” or “active from” waypoint. Clear the active route or GOTO before making your changes.

Accuracy has been Degraded—The accuracy of the GPS 12XL has been degraded beyond 500 meters due to poor satellite geometry or data quality. You should check other navigational sources to verify the position indicated.

Already Exists—The name you are entering already exists in the GPS 12XL's memory.

Approaching—You are one minute away from reaching a destination waypoint.

Battery Power is Low—The batteries are low and should be replaced.

No DGPS Position—Not enough data is available to compute a DGPS position.

No RTCM Input—Beacon receiver is improperly connected or baud rates do not match.

Poor GPS Coverage—The GPS 12XL cannot acquire the necessary number of satellites to compute a position. Try another location with a clearer view of the sky.

Power Down and Re-init—The GPS 12XL is not able to calculate a position due to abnormal satellite conditions. Turn the unit off and verify the last position shown by other means. Try the unit again later, possibly in a different location.

PROX Alarm—You have entered the alarm circle for a specific proximity waypoint.

Proximity Overlapped—The alarm circles of two proximity waypoints overlap which could cause difficulty in monitoring distances to each waypoint.

Proximity Wpt can't be Deleted—The waypoint you are trying to delete is listed as a proximity waypoint and must be removed from the list before it can be deleted.

Read Only Mem has Failed—The permanent memory has failed and the unit is not operable.

Received an Invalid WPT—A waypoint was received during upload transfer that has an invalid identifier.

Receiver has Failed—A failure in receiver hardware has been detected. If this message persists, do not use the unit and take it to an authorized dealer for repair.

Route is Full—You have attempted to add more than 30 waypoints to a route.

Route is not Empty—You have attempted to copy into a route already in use.

Route Waypoint Can't be Deleted—The waypoint you are trying to delete is part of a route. Delete the waypoint from the route before removing it from memory.

Route Waypoint was Deleted—A route waypoint entered does not exist in the database and has been deleted from the route

Messages & Time Offsets

RTCM Input has Failed—DGPS data being received has been lost. You are no longer receiving the beacon signal.

Searching the Sky—The GPS 12XL is in searching the sky for almanac data or the unit is in AutoLocate™ mode.

Stored Data was Lost—All waypoints, routes, time and almanac data has been lost due to battery failure or clearing the receiver's memory.

Track Memory is Full—All track log points in memory have been used. You must either delete the current tracklog or switch the record option to 'WRAP' which will begin erasing the oldest tracklog points as new ones are added.

Transfer has been Completed—The receiver is finished uploading or downloading information to the connected device.

WPT Memory is Full—You have used all 500 waypoints in the GPS 12XL. Delete unwanted waypoints to make room for new entries.

Time Offset Chart

The table below gives approximate UTC time offset for various longitudinal zones. If you are in daylight savings time, add one hour to the offset.

Longitudinal Zone	Offset	Longitudinal Zone	Offset
W180.0° to W172.5°	-12	E007.5° to E022.5°	1
W172.5° to W157.5°	-11	E022.5° to E037.5°	2
W157.5° to W142.5°	-10	E037.5° to E052.5°	3
W142.5° to W127.5°	-9	E052.5° to E067.5°	4
W127.5° to W112.5°	-8	E067.5° to E082.5°	5
W112.5° to W097.5°	-7	E082.5° to E097.5°	6
W097.5° to W082.5°	-6	E097.5° to E112.5°	7
W082.5° to W067.5°	-5	E112.5° to E127.5°	8
W067.5° to W052.5°	-4	E127.5° to E142.5°	9
W052.5° to W037.5°	-3	E142.5° to E157.5°	10
W037.5° to W022.5°	-2	E157.5° to E172.5°	11
W022.5° to W007.5°	-1	E172.5° to E180.0°	12
W007.5° to E007.5°	0		

Map Datums

The following list shows the map datums available for the GPS 12XL. Menu abbreviations are listed first, followed by the corresponding map datum name and area. The default map datum for the GPS 12XL is WGS 84.

Adindan	Adindan- Ethiopia, Mali, Senegal, Sudan	Easter Isld 67	(New Georgia Islands) Easter Island 1967
Afgooye	Afgooye- Somalia	European 1950	European 1950- Austria, Belgium, Denmark, Finland, France, Germany, Gibraltar, Greece, Italy, Luxembourg, Netherlands, Norway, Portugal, Spain, Sweden, Switzerland
AIN EL ABD '70	AIN EL ANBD 1970- Bahrain Island, Saudi Arabia	European 1979	European 1979- Austria, Finland, Netherlands, Norway, Spain, Sweden, Switzerland
Anna 1 Ast '65	Anna 1 Astro '65- Cocos Isl.	Finland Hayfrd	Finland Hayford- Finland
ARC 1950	ARC 1950- Botswana, Lesotho, Malawi, Swaziland, Zaire, Zambia, Zimbabwe	Gandajika Base	Gandajika Base- Republic of Maldives
ARC 1960	ARC 1960- Kenya, Tanzania	Geod Datm '49	Geodetic Datum '49- New Zealand
Ascnsn Isld '58	Ascension Island '58- Ascension Island	Guam 1963	Guam 1963- Guam Island
Astro B4 Sorol	Astro B4 Sorol Atoll- Tern Island	Gux 1 Astro	Gux 1 Astro- Guadalcanal Island
Astro Bcn "E"	Astro Beacon "E"- Iwo Jima	Hjorsey 1955	Hjorsey 1955- Iceland
Astro Dos 71/4	Astro Dos 71/4- St. Helena	Hong Kong '63	Hong Kong '63- Hong Kong
Astr Stn '52	Astronomic Stn '52- Marcus Island	Hu-Tzu-Shan	Taiwan
Astrln Geod '66	Australian Geod '66- Australia, Tasmania Island	Indian Bngldsh	Indian- Bangladesh, India, Nepal
Astrln Geod '84	Australian Geod '84- Australia, Tasmania Island	Indian Thailand	Indian- Thailand, Vietnam
Austria	Austria	Indonesia '74	Indonesia 1974- Indonesia
Bellevue (IGN)	Efate and Erromango Islands	Ireland 1965	Ireland 1965- Ireland
Bermuda 1957	Bermuda 1957- Bermuda Islands	ISTS 073 Astro	ISTS 073 ASTRO '69- Diego Garcia
Bogata Observ	Bogata Observatry- Colombia	Johnston Island	Johnston Island Kandawala Kandawala- Sri Lanka
Campo Inchspe	Campo Inchauspe- Argentina	Kerguelen Isld	Kerguelen Island, Kandawala, Sri Lanka
Canton Ast '66	Canton Astro 1966- Phoenix Islands	Kertau 1948	Kertau 1948- West Malaysia, Singapore
Cape	Cape- South Africa	L. C. 5 Astro	Cayman Brac Island
Cape Canavrl	Cape Canaveral- Florida, Bahama Islands	Liberia 1964	Liberia 1964- Liberia
Carthage	Carthage- Tunisia	Luzon Mindanao	Luzon- Mindanao Island
CH-1903	CH 1903- Switzerland	Luzon Philippine	Luzon- Philippines (excluding Mindanao Island)
Chatham 1971	Chatham 1971- Chatham Island (New Zealand)		
Chua Astro	Chua Astro- Paraguay		
Corrego Alegre	Corrego Alegre- Brazil		
Djakarta	Djakarta (Batavia)- Sumatra Island (Indonesia)		
Dos 1968	Dos 1968- Gizo Island		

Map Datums

Mahe 1971	Mahe 1971- Mahe Island		
Marco Astro	Marco Astro- Salvage Island		
Massawa	Massawa- Eritrea (Ethiopia)		
Merchich	Merchich- Morocco		
Midway Ast '61	Midway Astro '61- Midway		
Minna	Minna- Nigeria		
NAD27 Alaska	North American 1927- Alaska		
NAD27 Bahamas	North American 1927- Bahamas (excluding San Salvador Island)		
NAD27 Canada	North American 1927- Canada and Newfoundland		
NAD27 Canal Zone	North Am. 1927- Canal Zone		
NAD27 Caribbn	North American 1927- Caribbean (Barbados, Caicos Islands, Cuba, Dom. Rep., Grand Cayman, Jamaica, Leeward and Turks Islands)		
NAD27 Central	North American 1927- Central America (Belize, Costa Rica, El Salvador, Guatemala, Honduras, Nicaragua)		
NAD27 CONUS	North Am. 1927- Mean Value		
NAD27 Cuba	North American 1927- Cuba		
NAD27 Grnland	North American 1927- Greenland (Hayes Peninsula)		
NAD27 Mexico	N. American 1927- Mexico		
NAD27 San Sal	North American 1927- San Salvador Island		
NAD83	North American 1983- Alaska, Canada, Central America, CONUS, Mexico		
Nhrwn Masirah	Nahrwn- Masirah Island (Oman)		
Nhrwn Saudi A	Nahrwn- Saudi Arabia		
Nhrwn United A	Nahrwn- United Arab Emirates		
Naparima BWI	Naparima BWI- Trinidad and Tobago		
Obsrvtorio '66	Observatorio 1966- Corvo and Flores Islands (Azores)		
Old Egyptian	Old Egyptian- Egypt		
Old Hawaiian	Old Hawaiian- Mean Value		
Oman	Oman- Oman		
Ord Srvy GB	Old Survey Grt Britn- England, Isle of Man, Scotland, Shetland Isl., Wales		
Pico De Las Nv	Canary Islands		
Potsdam	Potsdam-Germany		
Ptcairn Ast '67	Pitcairn Astro '67- Pitcairn Is		
		Prov S Am '56	Prov So Amrcn '56- Bolivia, Chile, Colombia, Ecuador, Guyana, Peru, Venezuela
		Prov S Chln '63	Prov So Chilean '63- S. Chile
		Puerto Rico	Puerto Rico & Virgin Islands
		Qatar National	Qatar National- Qatar
		Qornoq	Qornoq- South Greenland
		Reunion	Reunion- Mascarene Island
		Rome 1940	Rome 1940- Sardinia Island
		RT 90	Sweden
		Santo (Dos)	Santo (Dos)- Espirito Santo Island
		Sao Braz	Sao Braz- Sao Miguel, Santa Maria Islands (Azores)
		Sapper Hill '43	Sapper Hill 1943- East Falkland Island
		Schwarzeck	Schwarzeck- Namibia
		Sth Amrcn '69	South American '69- Argentina, Bolivia, Brazil, Chile, Colombia, Ecuador, Guyana, Paraguay, Peru, Venezuela, Trinidad and Tobago
		South Asia	South Asia- Singapore
		SE Base	Southeast Base- Porto Santo and Madiera Islands
		SW Base	Southwest Base- Faial, Graciosa, Pico, Sao Jorge and Terceira Islands (Azores)
		Timbalai 1948	Timbalai 1948- Brunei and E. Malaysia (Sarawak and Sabah)
		Tokyo	Tokyo- Japan, Korea, Okinawa
		Tristan Ast '68	Tristan Astro 1968- Tristan da Cunha
		Viti Levu 1916	Viti Levu 1916- Viti Levu/ Fiji Islands
		Wake-Eniwetok	Wake-Eniwetok- Marshall Isl.
		WGS 72	World Geodetic System 1972
		WGS 84	World Geodetic System 1984
		Zanderij	Zanderij- Surinam

*Index***A**

Acquisition Time50
 Activating a Route28
 Active Route Page29
 Acquiring a position48
 Alkaline batteries50
 Altitude (ALT)15
 AutoLocate™48
 Average Speed (AVSPD) . .15

B

Battery Installation4
 Battery Level14
 Battery Life4, 50

C

CDI34, 44
 Cancelling a GOTO10
 Cautionsii
 Cigarette Lighter Adapter .51
 Clearing Routes29
 Clearing the Track Log 11,40
 Compass Page .7, 10, 31, 33
 Configuring the Map Page 38
 Copying Routes29
 Course deviation indicator 44
 Course to Steer (CTS) . . .32
 Creating Routes28
 Crosstrack Error (XTK) . .32
 Customer Service Dept. . .59

D

DGPS Interface45
 Date and Time41
 Deleting Waypoints22
 Distance/Sun Calculations 40

E

EZinit13, 48
 Editing Routes30
 Elapsed Time (ELPSD) . . .15
 Emergency Erase14
 Est. Time Enroute (ETE) .32
 Est. Time of Arrival (ETA) 32
 European Community Spec50

G

GOTO23
 Getting Started Tour8
 Going To a Waypoint9
 Graphic heading display . .15
 Graphic steering34

H

Highway Page31, 34

I

I/O format45
 Initializing48
 Interface Setup45
 Inverting a Route28

*Index***M**

Mag. Heading Reference . . .44
 Man Overboard Function .23
 Map Cursor37
 Map Datums43, 54
 Map Orientation38
 Map Page7, 9, 35
 Map Setup38
 Marking a Position8
 Maximum Speed16
 Maximum Speed (MXSPD) 15
 Menu Page7, 40
 Messages52

N

NMEA Formats51
 Navigating Routes28
 Navigation Page7, 31
 Navigation Setup43
 Nearest Waypoints18

O

On-Route GOTOs30
 Operating modes41

P

PC Kiti, 51
 Panning36
 Position Accuracy50
 Position Averaging17
 Position Formats43
 Position Page6, 15
 Power and Data Cables . . .51

Pre-defined waypoints . . .27
 Primary Pages6
 Proximity Waypoints19

R

Receiver Status13
 Reference Waypoints20
 Renaming Waypoints22
 Repairs50
 Routes
 Clearing29
 Copying29
 Creating28
 Editing30
 Inverting28
 Navigating Routes28
 On-Route GOTO's30
 Route Definition Page . .27
 Route Navigation26
 User-defined route27

S

Satellite Page6, 12
 Scanning Waypoints22
 Screen Backlighting . .14, 42
 Screen Contrast11, 42
 Signal Strength Bars12
 Simulator47
 Sky View12
 Specifications50
 System Setup41

*Index***T**

Time Format	41
Time Offset	53
TracBack Navigation	24
TracBack Tips	25
Track Log Display	24, 39
Track Method	39
Track Setup	39
Trip Timer (TTIME)	15
Troubleshooting	49
Turn (TRN)	32
Trip odometer	15

U

Units of Measure	44
User-defined route	27
User Grid	43
Using the Keypad	5
Using the Position Page	9

V

Velocity Made Good (VMG)	32
--------------------------	----

W

Warranty	59
Waypoints	
Comments	21
Definition Page	20
Deleting	22
Going to a Waypoint	9
Nearest Waypoints	18
Pre-defined Waypoints	27
Proximity Waypoints	19

Reference Waypoints	20
Renaming	22
Waypoint List	19
Waypoint Pages	18
Waypoint Symbols	21, 37

Z

Zooming	36
-------------------	----

LIMITED WARRANTY

GARMIN Corporation warrants this product to be free from defects in materials and workmanship for one year from the date of purchase. GARMIN will at its sole option, repair or replace any components which fail in normal use. Such repairs or replacement will be made at no charge to the customer for parts or labor. The customer is, however, responsible for any transportation costs. This warranty does not cover failures due to abuse, misuse, accident or unauthorized alteration or repairs. GARMIN assumes no responsibility for special, incidental, punitive or consequential damages, or loss of use.

The warranties and remedies contained herein are exclusive and in lieu of all other warranties expressed or implied, including any liability arising under warranty of merchantability or fitness for a particular purpose, statutory or otherwise. This warranty gives you specific legal rights, which may vary from state to state.

To obtain warranty service, call the GARMIN Customer Service department (913-397-8200) for a returned merchandise tracking number. The unit should be securely packaged with the tracking number clearly marked on the outside of the package, and sent freight prepaid and insured to a GARMIN warranty service station. A copy of the original sales receipt is required as the proof of purchase for warranty repairs. GARMIN retains the exclusive right to repair or replace the unit or software at its sole discretion.



© 1997 GARMIN Corporation

1200 E. 151st Street, Olathe, KS USA 66062

GARMIN (Europe) Ltd. - Unit 5, The Quadrangle,
Abbey Park, Romsey, Hampshire, SO51 9AQ, UK

Part Number 190-00134-00 Rev. C Printed in Taiwan